

Longman Children's

# Picture Dictionary

Teacher's Resource Book



PEARSON  
Longman

Aleda Krause • Keiko Abe-Ford

Longman **Children's**

# Picture Dictionary

**Teacher's Resource Book**



PEARSON  
Longman

**Aleda Krause • Keiko Abe-Ford**

Published by  
**Pearson Longman Asia ELT**  
20/F Cornwall House  
Taikoo Place  
979 King's Road  
Quarry Bay  
Hong Kong

fax: +852 2856 9578  
email: [pearsonlongman.hk@pearson.com](mailto:pearsonlongman.hk@pearson.com)  
[www.pearsonlongman.com](http://www.pearsonlongman.com)

**and Associated Companies throughout the world.**

© Pearson Education North Asia Limited 2003

All rights reserved; no part of this publication may be reproduced, stored in a retrieval system, or transmitted in any form or by any means, electronic, mechanical, photocopying, recording or otherwise, without the prior written permission of the Publishers.

First published 2003  
Reprinted by Pearson Education Asia Limited 2009

Produced by Pearson Education Asia Limited, Hong Kong  
EPC/12

ISBN-13: 978-962-00-5316-0  
ISBN-10: 962-00-5316-8

Publishing Director: Cynthia Lam  
Publishing Manager: Gregg Schroeder  
Commissioning Editor: Christienne Blodget  
Editor: Rachel Wilson  
Designer: Junko Funaki  
Illustrator: Teddy Wong

The  
publisher's  
policy is to use  
paper manufactured  
from sustainable forests



# Contents

	<b>Pages</b>
Introduction .....	4
Lesson Plan Template .....	5
Activities in the Picture Dictionary .....	6
<ul style="list-style-type: none"><li>• Introduce the Topic</li><li>• Introduce the Vocabulary</li><li>• Activities on the Dictionary Page<ul style="list-style-type: none"><li>Hidden Object</li><li>Activities</li><li>Dialogs</li><li>Songs and Chants</li></ul></li></ul>	
Additional Practice Activities .....	8
<ul style="list-style-type: none"><li>• Total Physical Response</li><li>• Activities</li><li>• Flashcard Games</li><li>• Workbooks</li><li>• Board Games</li></ul>	
Activity Bank .....	9
Flashcard Game Bank .....	14
Lesson Notes .....	16
Board Game Photocopiables .....	27
Flashcard Photocopiables .....	54



# Introduction

## Why use a picture dictionary? .....

The first, and perhaps most important reason, is for building vocabulary. The *Longman Children's Picture Dictionary* presents vocabulary words in context within 50 colorful and imaginative illustrations. All the selected topics are designed to engage children's imagination, stimulating them to learn and retain the vocabulary words.

Suggested activities and model substitution dialogs use a large number of the vocabulary words in meaningful situations. Learning the dialogs gives children a way to use the words in the topic while providing practice in some of the most common functions of language, such as asking for information or stating preferences.

Another reason for using a picture dictionary is to practice reading and writing. Many activities are suggested for this purpose in the *Teacher's Resource Book*. The *Workbooks* of this series offer additional opportunities for reading and writing practice through a variety of enjoyable activities.

Finally, a picture dictionary is useful for meaningful supplementary practice of textbook material. It offers a change from everyday routine that any class can appreciate.

## Using the Picture Dictionary as a supplement .....

A teacher using a textbook in class may choose to use the *Longman Children's Picture Dictionary* as a supplement to his/her textbook. There are several approaches.

The teacher can choose a topic that corresponds to a unit in the students' textbook. For example, if the students are learning about school, corresponding topics in the *Longman Children's Picture Dictionary* would be, Topic 38 The Schoolyard, Topic 39 School Day or Topic 40 School Bag Search.

The teacher can also choose functional dialogs that match the target language in the textbook. For example, if the textbook unit teaches asking and saying, *What's the matter?* Topic 47 At the Doctor's would be a good choice for additional meaningful practice.

The teacher can also choose activities or dialogs that match the grammar in the textbook. For example, if the textbook is teaching the *how many* pattern, appropriate dialogs can be found in Topic 23 Time and Shapes and Topic 44 Bugs and Little Creatures.

Finally, the teacher can simply let the students choose a topic they are interested in.

If the *Longman Children's Picture Dictionary* is used as a supplement, the teacher can use the entire suggested lesson plan, or only those parts there is time for.

## Using the Picture Dictionary as a course .....

A teacher may decide against using a textbook in class and use the *Longman Children's Picture Dictionary* as a course instead. This would be an appropriate choice, as the dictionary includes most of the words and structures introduced in most beginning level textbooks. Furthermore, used alongside the other components in the series, it provides a good balance of practice in the four skill areas of speaking, listening, reading and writing.

The teacher can choose to work through the dictionary from Topic 1 through Topic 50, introducing the vocabulary, doing the activities, practicing the dialogs, singing the songs and having the children complete the *Workbook* pages. Alternatively, the teacher can choose topics in random order, depending on what his/her students would most enjoy. In either case, the following suggested lesson plan would be appropriate.

# Lesson Plan Template

1	Introduce the topic.
2	Introduce the vocabulary using the CD as a pronunciation model.
3	Do the activities on the dictionary page: <ul style="list-style-type: none"><li>i. Find the hidden object.</li><li>ii. Work through the activities.</li><li>iii. Teach the dialogs using the CD as a pronunciation model. Then practice them by substituting new vocabulary words into the dialogs.</li><li>iv. Do the song or chant using the CD for the full and karaoke versions.</li></ul>
4	Do an additional practice activity from the Teacher's Resource Book: <ul style="list-style-type: none"><li>i. Give instructions for a Total Physical Response activity.</li><li>ii. Choose an idea from the Activity Bank.</li><li>iii. Play a card game from the Flashcard Game Bank using the Flashcard Photocopiables.</li></ul>
5	Use a Workbook page for reading and writing practice, or assign this for homework.
6	Review previous topics in pairs and small groups using the Board Game Photocopiables.



# Activities in the Picture Dictionary

## Introduce the Topic

Books closed. Introduce the topic. In the students' first language, ask what kind of words they would expect to find for this topic. Do they know any of the words in English already? Write them on the board.

Ask a personalized question about the topic in the first language to activate interest, then look at the page together. Which words do they already know? Have the children call out as you write or draw them on the board. Compare this list to the words already on the board.

## Introduce the Vocabulary

Books open. Model all the vocabulary words or play the CD and have the students repeat the words chorally. As you say the words, have the students find the items in the illustration. They can point to them, call out the numbers, or use simple location phrases (*next to, behind, in front of, on the left/right, at the top/bottom*) to say where they are. Repeat this stage to familiarize students with the sound of these new words.

## Activities on the Dictionary Page

### • Hidden Object

In each illustration, there is an item from Topic 1 Alphabet hidden on the page. Finding the hidden object is a fun and quick way to start the activities section of the lesson.

First have the students name the picture of the hidden object, then try to find it on the page. As each child finds it, he/she should raise a hand or stand up, rather than call out the location of the item, so everyone in the class has a chance to find it. Allow different students to take turns telling where the hidden object is.

You can also use the hidden object to review the alphabet. Once all the children have found the object, turn to Topic 1 Alphabet and ask them to find the same item in this illustration and say which letter it begins with.

### • Activities

Each topic contains one or more fun activities. Use these for practice or for personalizing the topic. In many cases the activity provides a model which is designed to be extended using other examples from the illustration. For example, Topic 18 Summer at the Beach Activity asks, *How many lifesavers can you see?* Extend this activity by asking about *pails, snorkels, surfboards, shovels*, etc. Some of the

activities are more difficult than others, so select those that seem appropriate for your students. Answers to the activities are in the Lesson Notes.

Some of the activity types included are:

- counting items in the picture
- doing actions using some of the vocabulary words
- making lists of things with something in common, such as color or the first letter
- putting words in alphabetical order
- closer observation of the picture to answer questions
- finding the odd-one-out — one item that is somehow different from the others
- talking about yourself and asking others about themselves

### • Dialogs

The useful, functional dialogs are designed to use most of the words in a topic in short, meaningful exchanges. Words in the dialogs and numbers in the word lists are color-coded, indicating which words can be substituted into each dialog.

The following steps can be used when introducing and practicing the dialogs:

1. Play the CD or model the dialog.  
The students listen.
2. Check that everyone understands the meaning of the dialog.
3. Play the CD or model the dialog again.  
The students repeat the lines chorally.
4. Divide the class in half. Play the CD or model the dialog again. Each half repeats their line chorally.
5. Play the CD or model the dialog again.  
Volunteers repeat the lines individually.
6. Invite one child to the front. Do the dialog together, taking the part with the substitution. Do the dialog once as it is written in the book, then do it again with a new word substituted into the dialog. Make sure the students understand that only the words with the same color can be substituted into the dialog.
7. Divide the class in half and assign each a line of the dialog. Say a word to be substituted and lead the children in choral practice.
8. The students can then practice the dialog in pairs, using their own substitutions.

### • Songs and Chants

Each topic contains either a song or a chant. Performing songs and chants helps students to practice the vocabulary and adds variety to classes. The songs and chants vary in level of difficulty, with the easiest material being chorused by a group of children on the CD. It may be better to have the students respond to the more challenging songs and chants by pointing at the illustrations on the page, or holding up flashcards as they listen, rather than perform them. Another option is to teach your students the chorus, or a part of the song/chant that is repeated throughout. Play the CD and have them join in when that part of the song/chant comes in.

The following steps can be used when performing the songs and chants:

1. Play the song/chant on the CD. Ask the students to listen to the rhythm and melody of the song or the rhythm of the chant.
2. Explain any vocabulary items that may need special attention. Draw the students' attention to plural forms of vocabulary words. Refer to the picture dictionary

topic, making sure that the students know the meaning of any new words.

3. For a song, practice it first as a chant to help the students with the rhythm and pronunciation.
4. Play the song/chant once through again to give the students another chance to hear the melody and rhythm.
5. Break the song/chant down into small sections and have the students practice it separately with the CD.
6. Finally, put the whole song/chant together and have the students perform with the karaoke version.





# Additional Practice Activities



## Total Physical Response .....

Total Physical Response (TPR) is a teaching method in which students practice English by responding to instructions. They do not have to speak, but show understanding by doing the actions.

Selected topics have suggested TPR instructions in the Lesson Notes. The following steps can be used to do a TPR exercise:

1. Say one instruction and do the action twice.
2. Repeat the instruction. Do the action with the students.
3. Do the same with the next instruction.
4. Stop modeling the action. Give both instructions. The students do the actions as individuals or as a class.
5. When students are responding confidently, introduce the next two instructions in the same way.
6. Give all instructions in random order. The students do the actions.



## Activities .....

There are 50 activity ideas in the Activity Bank. Most of them can be used in any topic. To cut down on lesson preparation time, there are three activity suggestions for each topic in the Lesson Notes.



## Flashcard Games .....

There are 12 card game ideas in the Flashcard Game Bank. There is a card game suggestion for each topic in the Lesson Notes, but any game can be used in any topic. Flashcard Photocopyables of all the dictionary vocabulary words are available at the back of this *Teacher's Resource Book*.

## Workbooks .....

Use the *Workbooks* to review vocabulary words during quiet time in the lesson. The *Workbooks* can also be used for homework. There are 50 activity pages, with each page covering a different Picture Dictionary topic.

## Board Games .....

Board games give students the chance to review vocabulary words in pairs and groups. There are 27 board games in total and each one recycles vocabulary words from several topics. These topics are linked by a common theme. To use the board games, make enough photocopies for the students to use in pairs or in groups.



# Activity Bank

- **Alphabet circle**

Have students sit in a circle. Choose one student to be first. The students sing the Alphabet Song, or chant it, each student saying one letter.

- **Alphabet run**

Divide the class into teams of four students. Give each team a marker or piece of chalk. Have the students number off from 1–4 in each team. S1 from each team runs to the board and writes an upper case *A* or lower case *a*, then returns to his/her team and gives the marker to S2. S2 runs to the board and writes *B* or *b* next to the *A*, then returns and gives the marker to S3. The game continues until all the letters of the alphabet have been written on the board.

- **A or an?**

Have the students find all the words that take *an* instead of *a*. The students can say the words, write them on the board, or write them on paper at their desks.

- **Bombs**

Choose a word and write a blank on the board for each letter of the word, e.g. for the word *refrigerator*, write:

\_\_\_\_\_

Also draw a bomb with a long string on it. Divide the string into eight parts. Draw a fire at the end of the string. The students take turns guessing letters, trying to complete the word or guessing what it is and spelling it. Each time they guess a letter that is in the word, write it on the correct line. Each time they guess a letter that isn't in the word, erase part of the string — the fire keeps getting closer! The students try to guess the word before the bomb explodes.

- **Buzz**

Choose a number from 1–9 as the Buzz number, e.g. 5. The students sit in a circle and count consecutively around the circle. Anytime a number contains a 5 or is a multiple of 5, that student must say Buzz instead of the number, e.g. 1, 2, 3, 4, *buzz*, 6, 7, 8, 9, *buzz*, 11, 12, 13, 14, *buzz* ... Start again if someone makes a mistake or you reach 20.

- **Chains**

Display the illustration so everyone can see it. S1 says any word he/she knows. S2 repeats that word, points to it and says another. S3 repeats both words, pointing to them, and says another. Continue around the class. The students may use words more than once.

- **Color commands**

Have each student choose a color they like. Give commands like, *Red, stand up!* or, *Green, touch your nose!* The students who have chosen that color do the command. After playing for a while, ask the class if they can guess which color the other students chose.

- **Complete the word**

Write part of a word on the board, leaving out some letters. The students complete the word on the board or on paper at their desks, then say the word.

- **Compliments**

Give each student five pieces of paper. Play some lively music. While the music plays, the students walk around the room. Stop the music often. When the music stops, the students find a partner and try to give that partner a compliment before the partner gets a chance to say anything, e.g. *I like your shirt!* If they give the first compliment, they can give their partner a piece of paper. The first student to get rid of all their papers is the winner.

- **Crosswords**

The students take turns writing words from the topic on the board, horizontally and vertically, linking the words by one or more letters, like in a crossword puzzle. For example, students might write:

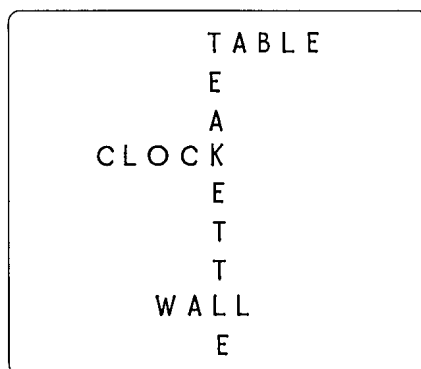

The activity continues until everyone has had a turn. The words may be used more than once.

This game can also be played in pairs or small groups.

### • Do as I say

Point to a part of your body, e.g. your head, and say something about another part of your body, e.g. *My stomach hurts.* or *This is my stomach.* The students repeat the line and point to the correct part of the body. The students who make a mistake sit down and watch for other mistakes.

### • Draw and label

Choose a topic and invite a student to quickly draw the illustration on the board. Have another student label the various parts, with the class calling out vocabulary items.

### • Draw and write

Draw pictures on the board and have the students write the words.

### • Draw and write yourself

Have the students draw pictures on the board and other students write the words.

### • Family album

The students draw pictures of their family members, or bring in photos of their family, then tell others who the people are, using, *This is my (sister).* Remind the students to include their pets!

### • Fashion show

Individual students walk around the room like models in a fashion show. Others announce what they are wearing, e.g. *Carl is wearing a checked shirt, blue jeans, and yellow shoes.*

### • Feely bag

Collect the items in Topic 40 School Bag Search from your students. Put them all into a big bag or on a table under a large cloth. The students take turns reaching into the bag or under the cloth, feeling an item, and guessing what it is without looking at it. For an extra challenge, the students can also guess whose item they are feeling.

### • First sound

Have the students find all the words in an illustration that start with a certain sound, e.g. a single consonant, a consonant blend or a vowel.

### • How do you eat it?

Name a breakfast food or drink item from Topic 11 Breakfast Time. The students say what kitchenware they need to eat or drink it, e.g. *eggs-plate; coffee-cup (and saucer); cereal-bowl.*

Alternatively, name a food or drink and the students say what goes in or on it, e.g. *glass-orange juice; plate-pancakes; toast-butter (and jam).* Whoever answers correctly names the next item. The same can be done with Topic 30 Dinner at the Restaurant.

### • Identification

Label classroom objects with numbers before the students enter the room. Divide the students into two teams and have them line up. Ask the students at the front of the lines, e.g. *What number is the window? What is number eight?* The first two students then move to the back of their lines. The next two try to answer a question. Continue until all the students have had at least one turn.

### • Last sound

Have the students find all the words in the picture that end with a certain sound, e.g. a consonant, a consonant blend or a vowel plus /r/.

### • Lotto

Each student chooses five words he/she likes, then draws pictures of them on a piece of paper. The students take turns calling out a word. When a word is called out, everyone who has that word crosses it out. The first student to cross out all his/her words is the winner.

### • Match it

The students take turns naming an animal from Topic 42 Animal Orchestra. The other students try to be first to name the instrument that animal is playing. The student who is first to name the instrument correctly gets to name the next animal. The students may try to trick the others by naming an animal that isn't in the picture.

Alternatively, the students may name an instrument and others try to name the animal playing it.

- **Middle sound**

Have the students find all the words in the picture that have the same vowel sound in the middle position.

- **Mimes**

Choose a word and have a student act it out or mime the word to the whole class or to a small group. The class or group try to guess what the word is. The student who guesses the word gets to mime the next word.

- **Name it**

Say any of the items in an illustration. The students try to say, or write on the board, the letter it begins with.

- **Point and say**

Point to a picture or word, or say a number from the word list. The students say the corresponding word.

- **Point and write**

Point to a picture or say a number. Students write the word.

- **Puzzles**

Find large pictures of the items on the page in a magazine. The pictures can be single items or combinations of items. Glue each picture to a piece of card, then cut each picture into four or more pieces. Give each student a piece from one of the puzzles. Students try to find the other students who have the same picture, without showing their picture to anyone else. Instead, they have to tell others about their own pictures, e.g. *My (monster) is green.* or *I have (a computer game).*

- **Recall the words**

Have the students look at an illustration for 15–30 seconds. Close books. The students try to recall as many words as possible.

- **Really? Really!**

Make statements that are true or false, e.g. *A doctor works in a hospital.* or *A doctor works in a restaurant.* Students answer *Really?* to the

false statements and *Really!* to the true statements. Let the students try to make statements, too.

- **Remember**

Have pairs of students sit back to back. Can they remember what colors or clothes their partners are wearing? Alternatively, have all students close their eyes. Can they remember colors of things in the room?

- **Say and point**

Say a word. The students point to the word and say its number.

- **Say and write**

Say some words. Students write them.

- **Scan**

Tell students to look through their picture dictionaries to find a certain picture. The first student who finds the picture raises a hand and points to the picture. The rest of the students may find the same picture on different pages. Repeat the activity and have the students take turns calling out suggestions.

- **Scramble**

Write scrambled words on the board. The students unscramble them and say the words. Books open or closed.

- **Scramble and write**

Write scrambled words on the board. The students unscramble them and write the words. Books open or closed.

- **Stand in order**

Give 8–10 students each a card with a number on it. Call the numbers in a random order. The students line up in front of the room in the correct order. The others in the class check to see if they agree.

- **Surveys**

The students design a survey and interview five classmates in class or ten people for homework.

In designing the survey, students use the patterns in the dialogs or simple question forms like, *What's your favorite (fruit)? Do you*

have a (pet)? Can you do a (headstand)? In lower level classes, dictate the questions. The form might look like this:

Name	What's your favorite fruit?	Can you do a headstand?
Kate	mango	Yes
Ben	pear	Yes
Sarah	mango	No
Max	banana	No
Billy	mango	Yes
Alice	banana	Yes

In class, students create a graph incorporating all their answers:

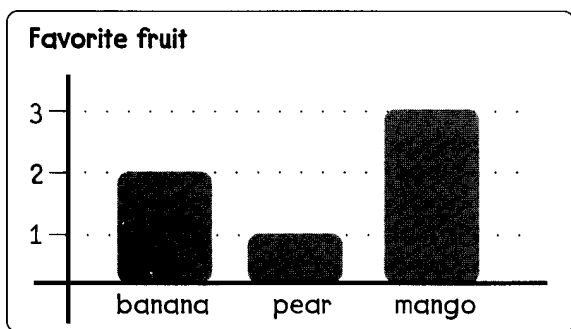

### • Taste it

Bring in some of the fruits from Topic 6 Fruit in the Gym, or ask students to each bring in a different piece of fruit. Peel and cut up the fruit. Tell the students to wash their hands. Give different students a piece of fruit to taste. Can they name the fruit? Have the students try to name the fruit blind-folded. Then have them try to name the fruit blind-folded and holding their noses so they can't smell it. Can they still name the fruit correctly?

### • Throw the dice

Give the students 1-3 dice. The students take turns throwing the dice. They say the word that corresponds to the number in the word list. Use this activity in topics with 18 or less vocabulary words.

### • Tiger

Point to a part of your body, e.g. your foot, and ask about a tiger's body part, *Does a tiger have a foot?* The students must point to the same body part and say the corresponding tiger body part, *A tiger has a paw.* The students who make a mistake sit down and watch for other mistakes.

### • What comes before?

Call out a number. The students try to be first to call out the number that comes before the number you said. The first to call out the correct number gets to call the next number. This activity is suitable for any sequential vocabulary, such as time, months, days.

### • What does it say?

The students take turns asking, *What sound does a (cow) make?* about different farm animals or pets. The student who answers correctly asks the next question.

### • Which one?

Say one of the adjectives. The students try to be first to find the item in the picture that depicts that adjective. The student who names the item first says the next adjective.

### • Who was first?

Have three students come to the front of the class. Have them write their names on the board, then sit down, as quickly as possible. When they have finished, ask the rest of the class, *Who was first? Who was second? Who was third?* Invite the three students who answer the questions correctly to the front. Have them do a different task (jump 15 times, say the alphabet, count to 20, etc.) and sit down. This time ask, *Who was third? Who was second? Who was first?* Repeat a few times.

### • Word web

Write one word in the middle of the board and create a word web with some spaces left blank. The students fill in words. Alternatively, have the students create their own webs. (This is an example for Topic 13 Evening in the Living Room.)

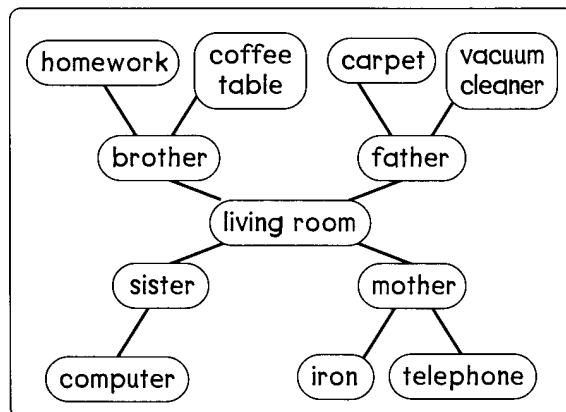

- **Write and draw**

Write words on the board. Books open or closed. The students draw corresponding pictures next to the words.

- **Writing lotto**

Each student chooses five words he/she likes and writes them on a piece of paper. The students take turns calling out a word. When a word is called out, everyone who has that word crosses it out. The first student to cross out all his/her words is the winner.

- **Write the numbers**

Write selected words on the board, books open. The students write the corresponding numbers next to the words on the board.



# Flashcard Game Bank

## • Card chase

**(two full set of cards from a topic, timer, box)**

Before class, set up two tables at opposite ends of the room. Pile one set of cards on each table. Divide the class into two teams and send them to the different tables. Put a box on the Team A table. The teams compete to collect the most matching cards. Students in both teams take a card from their own tables. The students in Team A run and ask the students in Team B if they have their matching cards. If they do, Team B students hand over their cards and take new cards from their own table. Team A students return to their table and put the matching cards into the box. If they don't find a matching card, Team A students return to their table and take a new card, remembering to put their original card at the bottom of the pile. After four minutes, count the number of matching cards in the box. Then, have the teams change roles.

## • Card collector

**(four cards per student)**

Divide the students into small groups. Give each group enough cards so that the group members can have four cards each. The groups spread the cards on their table, face up. Let the students memorize them for a minute. Have the students shuffle and deal the cards equally without others seeing. The aim is to collect the most cards. Students take turns asking each other for certain cards. The students are not allowed to ask for the same card repeatedly or consecutively. If a student has a card, he/she must hand it over. If he/she doesn't, the next student asks someone for another card, e.g. S1: *(Kate) can I have the (octopus), please?* S4: *Sorry, I don't have the (octopus).* S2: *(Ben), can I have the (necklace), please?* S3: *Sure. Here you are.*

## • Concentration

**(full set of cards from a topic, one set per student)**

Put the students into pairs. Have the pairs spread their cards together on a table, face down. S1 turns over any two cards, saying what's on each card. If the cards are the same, S1 takes them and goes again. If the cards are

different, S1 turns them back over and S2 takes a turn. Continue until all of the cards have been taken. The aim is to collect the most cards. For a greater challenge, have the pairs use three sets of cards, following the same procedure. If this is too difficult, reduce the number of cards.

## • Dice act

**(one set of cards from six topics, dice)**

Put the sets of cards into six separate piles on a table under the board. Write 1, 2, 3, 4, 5, 6 on the board, over the piles. Divide the class into four teams. Invite a student from Team A to the front. The student rolls the die. The number on the die tells the student which pile he/she can take a card from. The student takes a card and tries to mime the word. The first person to guess the word gets a point for his/her team. Keep playing so that everyone has a chance to participate. Give bonus points if students can name the topic where the word appears.

## • Find the joker

**(one card per student)**

Have the students sit in a circle and show them the cards. Choose one card to be the joker and tell the students which one it is. Shuffle and give each student a card without the other students seeing. The aim of the game is to find the joker. The students take turns asking each other what cards they have. Everyone, excluding the student with the joker, answers truthfully, e.g. S1: *What do you have?* S2: *I have (a cherry).* S1 can challenge S2 saying, *I don't believe you.* S2 then shows his/her card. If S1 is correct, he/she gets a point. If S1 is wrong, he/she is out of the game for the rest of the round. Repeat the game several times.

## • Flash

**(one set of cards from a topic)**

Pile the cards on a table, face down. Pick up one card and show it to students very quickly for about a second. Have the students say what's on the card. Show the card repeatedly until a student gives the correct word. Show the card to make sure that everyone can see it. Whoever says the correct word first shows the next card.

- Telephone line

- (one set of cards from a topic)

Divide the class into two groups and have them stand in two rows facing the board. Place the cards on the board. Whisper one of the words to the two students at the back of each row. Say, *Go!* Each student passes the word on by whispering it to the student in front of him/her. When the word reaches the students at the front of the rows, they race to take the correct card from the board.

- Photo memory

- (full set of cards from a topic, one set for each group)

Put the students into small groups. Give each group a set of cards and have them spread the cards on their table, face up. Invite a student from each group to the front. Open the Picture Dictionary to that topic. Point to any six items. The students try to remember the six items and return to their tables. They look for the cards, put them aside, face up. If the students can't remember all six items, another student can come to the front. Point to the same items as before. Groups repeat this procedure until they are confident that they know all of the items. When a group is ready, have the students in that group call out the words.

- Rock, paper, scissors race

- (full set of cards from one topic/mixed set)

Divide the class into two teams. Put the flashcards face up in a line on a long table. The teams stand at opposite ends of the table. Say, *Go!* and one student from each team starts to move down the line, touching the cards and saying what each item is. When the students meet, have them play rock, paper, scissors. The student who loses rushes back to his/her team and another teammate begins moving down the line, starting at the first card. The winner keeps moving. Give a point to the student who reaches the opposite team first.

- Spell it

- (one card per student)

Make a list of the cards being used in this game. Give one card to each student. Choose any card and spell the word, e.g. *b-a-l-l*. The student with the corresponding card stands up and shows it to the class. He/she says the word and spells it.

- Swat

- (full set of cards from a topic)

Spread the cards on a table at the front of the room. Have the students make two teams and line up. Invite the students at the front of both lines to the table. Call out one card, e.g. *Air conditioner!* The students race to swat the correct card first. The winner gets a point and both students return to the back of their lines. Repeat the game until everyone has played at least one round. The teams try to collect the most points.

- Tell me why?

- (full set of cards from a topic)

Spread the cards on a table, face up. Each student takes one card. Play some music and have the students walk around the room holding their cards. Stop the music, and the students do a dialog with the student closest to them. The students show their cards and ask each other why they chose their cards. Start the music again and repeat the game.



# Lesson Notes

## Topic 1 Alphabet

### • Notes

One alphabet item is hidden in each illustration as the hidden object.

### • Answer Key

#### Activities

1. snake: s  
ladybug: l
2. c: cat, camel  
f: flower, fish

### • Practice

**Activity Bank:** Alphabet circle, Alphabet run, Scan

**Flashcard Game Bank:** Rock, paper, scissors race

## Topic 2 Numbers

### • Notes

The plural of **fish** is fish or fishes. The plural of **tomato** is tomatoes.

### • Answer key

#### Hidden object

Jacket: on one of the geckos.

### • Practice

**Activity Bank:** What comes before?, Buzz, Stand in order

**Flashcard Game Bank:** Spell it

## Topic 3 Colors under the Sea

### • Notes

A **shark** is a very large fish. Many have sharp teeth and powerful jaws. Most sharks are not dangerous and many types are endangered. A **whale** is not a fish. It is the largest mammal. It is warm-blooded and baby whales drink their mothers' milk. Many whales are endangered. Some **turtles** live on land and others live in the water. The giant sea turtle is the largest water turtle. Many turtles are endangered. A **mermaid** is a mythical creature, said to be half woman and half fish.

### • Answer key

#### Hidden object

Yo-yo: a little yellow fish near the seaweed is playing with it.

#### Activities

1. Yellow things: submarine, fish, shell  
Brown things: rock, shipwreck, treasure chest

### • Practice

**Activity Bank:** Color commands, Remember,

First sound /s/

**Flashcard Game Bank:** Photo memory

## Topic 4 Colorful Sea Creatures

### • Notes

A **seahorse** is an unusual fish with bony plates. It looks like a horse or a dragon. It curls its tail around seaweed to stay in a protected area. Many seahorses are endangered. A **starfish** usually has five arms. If one is lost, it can grow a new one. A **jellyfish** isn't a real fish because it doesn't have gills or fins. Some jellyfish are poisonous. A **dolphin** is not a fish. It is a mammal. It is warm-blooded and baby dolphins drink their mothers' milk. Dolphins are very intelligent. An **octopus** has eight tentacles or arms. The plural is octopi. **Neptune** is the Roman god of the sea.

### • Answer key

#### Hidden object

Horse: in the treasure chest.

#### Activities

1. Three seahorses: pink, purple, orange  
Four starfish: blue, purple, green, red
2. Something red: crab, jellyfish, starfish

### • Practice

**Activity Bank:** Color commands, Chains, Lotto

**Flashcard Game Bank:** Concentration

## Topic 5 Vegetable Party

### • Answer key

#### Hidden object

Necklace: the carrot is wearing it.

#### Activity

Six green vegetables: bean, lettuce, broccoli, cabbage, cucumber, green pepper

Two orange vegetables: carrot, pumpkin

### • Practice

**Activity Bank:** Puzzles, Mimes, Scramble

**Flashcard Game Bank:** Telephone line

## Topic 6 Fruit in the Gym

### • Notes

Other fruits can be found in Topic 29 Picnic Lunch. In the picture, the **mango** is vaulting the box; the **papaya** is swinging on the rings with the **plum** spotting him; the **cherry** is walking on a balance beam; the **banana** is climbing the rope; and the **lemon** is jumping on the trampoline. Another name for a **somersault** is a forward roll.

• **Answer key**

**Hidden object**

Watch: the banana is wearing it.

**Activities**

1. Handstand: strawberry, kiwi  
Somersault: apple
2. Four fruits start with p: peach, pear, papaya, plum

• **TPR**

Climb the rope. Balance on the beam. Jump over the box. Bounce on the trampoline.

• **Practice**

**Activity Bank:** Taste it, Puzzles, A or an?

**Flashcard Game Bank:** Flash

## Topic 7 Our Busy Town

• **Notes**

Other places around town can be found in Topic 8 Getting Around and Topic 50 Growing Up.

• **Answer key**

**Hidden object**

Tiger: on the street near the pet shop.

**Activity**

Places that sell things: supermarket, bakery, toy store, bookstore, pet shop, flower shop

Places that don't sell things: movie theater, swimming pool, park, museum, library, apartment building

• **TPR**

Stop at the crosswalk. Look both ways.  
Wait for the green light. Walk across the street.

• **Practice**

**Activity Bank:** Mimes, Surveys (*Where do you like to go in town?*), Write the numbers

**Flashcard Game Bank:** Tell me why

## Topic 8 Getting Around

• **Notes**

A motorcycle is sometimes called a motorbike.

• **Answer key**

**Hidden object**

Camel: on the purple boat.

**Activities**

1. t words in alphabetical order: taxi, train, truck

• **Practice**

**Activity Bank:** Chains, Scramble and write, A or an?

**Flashcard Game Bank:** Dice act

## Topic 9 My Family Album

• **Notes**

Sister can be either an older (big) sister or a

younger (little) sister. **Mom** is also sometimes called Mother or Mommy. **Grandma** is also sometimes called Grandmother, Granny, Grammie, Gran, or Nana. **Brother** can be either an older (big) brother or a younger (little) brother. **Dad** is also sometimes called Father or Daddy. **Grandpa** is also sometimes called Grandfather or Gramps. **Cousins** can be male or female.

• **Answer key**

**Hidden object**

Zebra: on the bookcase.

**Activities**

1. Teddy bear: Sarah's sister  
Flowers: Sarah's cousin and grandma  
Glasses: Sarah's uncle, aunt, grandma and grandpa

• **Practice**

**Activity Bank:** Family album, Surveys (*How many people are in your family? Who are they?*), Writing lotto

**Flashcard Game Bank:** Concentration

## Topic 10 Morning in the Bathroom

• **Notes**

Topics 10–14 feature the lion family — the mom, dad, brother, sister, baby and grandma, in different rooms of the house at different times of the day.

• **Answer key**

**Hidden object**

Fish: on the small towel hanging near the sink.

**Activity**

The brother lion is using a toothbrush.  
The sister lion is using a hairbrush.

• **Practice**

**Activity Bank:** Puzzles, Mimes, First sound /s/ or /sh/

**Flashcard Game Bank:** Telephone line

## Topic 11 Breakfast Time

• **Notes**

The family is having breakfast. The sister lion has dropped her bowl. Different ways of cooking **eggs** include scrambled, fried and boiled. **Jam** without little pieces of fruit in it is called jelly. **Pancakes** are often eaten with butter and maple syrup.

• **Answer key**

**Hidden object**

Gecko: near the microwave.

**Activities**

1. The baby lion: yogurt, cereal, toast and jam  
The brother lion: cereal and yogurt

• **Practice**

**Activity Bank:** Chains, Complete the word, How do you eat it?

**Flashcard Game Bank:** Card collector

## Clean Up the Kitchen

• **Notes**

The brother and sister lion have just helped their grandma make a cake.

• **Answer key**

**Hidden object**

Rainbow: on a container on the shelf.

**Activity**

Something beginning with w: window, wall

• **Practice**

**Activity Bank:** Mimes, Bombs, Crosswords

**Flashcard Game Bank:** Card chase

## Evening in the Living Room

• **Notes**

In the picture, the sister is using the computer; the dad is vacuuming the carpet; the brother is doing his homework; the grandma is listening to music; the baby is doing a puzzle and the mom is doing the ironing.

• **Answer key**

**Hidden object**

Bird: in the family picture, on the dad's head.

**Activity**

Doing homework: brother lion

Using the computer: sister lion

• **Practice**

**Activity Bank:** Puzzles, Word web, Draw and label

**Flashcard Game Bank:** Swat

## Storytime in the Bedroom

• **Notes**

The brother and sister are getting ready for bed. Their dad is reading them a story.

• **Answer key**

**Hidden object**

Mermaid: behind the sister lion's pillow.

• **Activities**

1. Four things beginning with b: bookcase, blanket, bed, bathrobe

• **Practice**

**Activity Bank:** Throw the dice, Recall the words, Draw and write

**Flashcard Game Bank:** Find the joker

## Topic 15 Out in Space

• **Notes**

The names of the nine **planets** in our solar system are: Mercury, Venus, Earth, Mars, Jupiter, Saturn, Uranus, Neptune and Pluto. The planets shown in the illustration are: Earth, Mars and Saturn. A **shooting star** is sometimes called a meteor. It is a chunk of rock or metal burning through the earth's atmosphere and can be seen for a few seconds. A **comet** orbits or circles the **sun** and is larger than a shooting star. It has a bright tail and can be seen for several nights. However, easily visible comets are rare. Hundreds of man-made **satellites** orbit the earth. We use them for many things such as linking the earth with telephone and television and forecasting the weather. A **space shuttle** is launched by rockets and returns to earth by landing on an airstrip. A space shuttle can be used again and again. The **Big Dipper** is the seven brightest stars of the Ursa Major (Big Bear) constellation. The **North Star** is the star in the northern hemisphere that looks like it never moves because the axis of the earth points towards it. The **Southern Cross** is four bright stars in the southern hemisphere that look like a cross.

• **Answer key**

**Hidden object**

Orange: in the back of the space shuttle.

**Activity**

The Big Dipper: seven stars

The Southern Cross: four stars

• **Practice**

**Activity Bank:** Chains, Lotto, Crosswords

**Flashcard Game Bank:** Flash

## Topic 16 The Weather

• **Answer key**

**Hidden object**

Iceberg: in the *snowy* illustration.

**Activities**

1. The polar bear likes cold, warm, cool, snowy, rainy, sunny and windy weather.

• **Practice**

**Activity Bank:** Write the numbers,

Last sound /y/, Writing lotto

**Flashcard Game Bank:** Rock, paper, scissors race

## Topic 17 Spring on the Farm

• **Notes**

The husband and wife are both **farmers**. In English, **cows** say *moo*, **sheep** say *baa*, **hens** say *cluck-cluck*, **chicks** say *cheep-cheep*, **roosters** say *cock-a-doodle-doo* and **ducks** say *quack-quack*. A **scarecrow** is made from old clothes and straw and is put in a field to scare away birds.

• **Answer key**

**Hidden object**

Violin: in the grass by the pond.

**Activities**

1. Four legs: cow, calf, horse, sheep, lamb, goat  
Two legs: hen, chick, rooster, duck, duckling
2. Young duck: duckling  
Young sheep: lamb

• **Practice**

**Activity Bank:** Puzzles, What does it say?,  
Surveys (*Have you ever fed a cow? A sheep?*)

**Flashcard Game Bank:** Spell it

## Topic 18 Summer at the Beach

• **Notes**

Some of the things people are doing at the beach include, from top left to right: water skiing, sailing, swimming, catching a fish, rowing a boat, surfing, splashing in the water, playing beach volleyball, snorkeling, eating ice cream cones, making a sand castle, sunbathing, putting on sunscreen.

• **Answer key**

**Hidden object**

Whale: behind the sandcastle.

**Activity**

Lifesavers: five

• **Practice**

**Activity Bank:** Name it, Word web, Crosswords

**Flashcard Game Bank:** Dice act

## Topic 19 Fall in the Forest

• **Notes**

The plural of **mouse** is mice. The plural of **deer** is deer or deers. Of the foods listed, **squirrels** eat acorns, nuts, seeds; mice eat seeds, nuts, berries; raccoons eat nuts; deer eat leaves, grass, acorns, nuts, berries; rabbits eat grass.

• **Answer key**

**Hidden object**

Hat: in the second tree from the left.

**Activities**

1. Rabbits: four  
Squirrels: two
2. Fall leaves: red, orange, gold, yellow, brown

• **Practice**

**Activity Bank:** Mimes, Complete the word,  
Middle sound /i/ or /ee/

**Flashcard Game Bank:** Card collector

## Topic 20 Winter in the Park

• **Notes**

The boy in the lower left corner is making a snow angel. To do this, lie down and move your arms through the snow. When you stand up, the shape

left in the snow looks like an angel. A snowman traditionally has a carrot for a nose and eyes made of pieces of coal.

• **Answer key**

**Hidden object**

Penguin: behind the bench.

**Activity**

Having a snowball fight: four  
Sledding: two

• **Practice**

**Activity Bank:** Lotto, Mimes, Surveys (*Do you like making a snowman? Do you like skiing?*)

**Flashcard Game Bank:** Swat

## Topic 21 Months and Seasons

• **Notes**

These illustrations show the months and seasons in Canada. The activities in each month scene are: **January** – making a snowman, **February** – exchanging Valentine cards, **March** – flying kites, **April** – splashing in puddles, **May** – celebrating Mother's Day, **June** – riding bikes, **July** – having a picnic, **August** – playing at the beach, **September** – going back to school for the new school year, **October** – playing in the leaves, **November** – watching television, **December** – sweeping snow. The activities in each season scene are: **spring** – picking flowers, **summer** – having a picnic, **fall** – jumping in the leaves, **winter** – making a snow angel.

• **Answer key**

**Hidden object**

Dog: in the *October* illustration.

**Activities**

1. Fly a kite: March  
Go back to school: September

• **Practice**

**Activity Bank:** Name it, Stand in order, Scramble and write

**Flashcard Game Bank:** Tell me why

## Topic 22 Every Day

• **Notes**

**Monday** through **Friday** are weekdays. **Saturday** and **Sunday** are the weekend.

• **Answer key**

**Hidden object**

Notebook: on the piano.

**Activities**

1. Thursday is between Wednesday and Friday.  
Tuesday is after Monday.

• **TPR**

Do some ballet. Do a karate kick.  
Play the piano. Kick the soccer ball.

- **Practice**

**Activity Bank:** Stand in order, What comes before?, Surveys (*What's your favorite day? Why?*)

**Flashcard Game Bank:** Card chase

## Topic 23 Time and Shapes

- **Notes**

The front of a clock consists of the clock face with the numbers, the hour hand and the minute hand to show the time. The adjective most commonly used for **circle** is round, for **triangle** is triangular, for **rectangle** is rectangular.

- **Answer key**

**Hidden object**

Snake: the six o'clock hour hand.

**Activities**

2. Heart-shaped clocks: five o'clock, nine o'clock

- **Practice**

**Activity Bank:** Lotto, Say and write, Write and draw

**Flashcard Game Bank:** Photo memory

## Topic 24 Toy Box

- **Answer key**

**Hidden object**

Tomato: in the toy box near the comic book.

**Activity**

p words in alphabetical order: panda, puppet, puzzle

- **Practice**

**Activity Bank:** Mimes, Throw the dice, Surveys (*Do you have a rocket?*)

**Flashcard Game Bank:** Telephone line

## Topic 25 Fairytale Castle

- **Notes**

The royal households of the red and blue castles have come together for a celebration. The characters are wearing blue ribbons or red ribbons to show whether they come from the blue castle or the red castle. The **frog** is sad because he is really a **prince**. The story goes that if the **princess** gives him a kiss, the spell will be broken and he will become a prince again.

- **Answer key**

**Hidden object**

Monster: in the trees.

**Activity**

The queen is eating a piece of cake.  
The wizard is eating salad.

- **Practice**

**Activity Bank:** Chains, Write the numbers, Scramble

**Flashcard Game Bank:** Flash

## Topic 26 Pirate Ship

- **Notes**

The pirates are sailing toward the **island** to look for buried treasure. This is marked on the **treasure map** with an X. The pirate at the top of the ship is in the crow's nest. The other pirate and the **pirate captain** are on deck. The **bottle** has a **message** in it. This refers to a tradition of writing a message, putting it in a bottle and throwing the bottle out to sea to see if anyone finds it.

- **Answer key**

**Hidden object**

Octopus: on the rudder at the back of the ship.

**Activities**

1. Odd-one-out: the hook belongs to the pirate captain.

- **Practice**

**Activity Bank:** Word web, Bombs, Recall the words

**Flashcard Game Bank:** Concentration

## Topic 27 Fairytale Ball

- **Notes**

This illustration combines many different fairytale themes and characters.

- **Answer key**

**Hidden object**

Cat: behind the toadstool on the left.

**Activity**

Toadstools: ten  
Fairies: ten

- **Practice**

**Activity Bank:** Chains, Write and draw, Complete the word

**Flashcard Game Bank:** Find the joker

## Topic 28 Birthday Party

- **Answer key**

**Hidden object**

Rocket: behind the puppet's chair.

**Activities**

1. The doll is eating a hamburger.  
The robot is eating a piece of cake.

- **TPR**

Light the candles. Make a wish.  
Blow out the candles. Cut the birthday cake.

- **Practice**

**Activity Bank:** Puzzles, Lotto, Draw and write yourself

**Flashcard Game Bank:** Tell me why

## Topic 29 Picnic Lunch

- **Answer key**  
**Hidden object**  
Duck: behind the tea.  
**Activity**  
Sweet foods: pudding, watermelon, grapes, melon, pineapple, popcorn, candy, chocolate  
Salty foods: cheese, bread, fried chicken, potato chips, popcorn
- **Practice**  
**Activity Bank:** Chains, Bombs, Recall the words  
**Flashcard Game Bank:** Rock, paper, scissors race

## Topic 30 Dinner at the Restaurant

- **Answer key**  
**Hidden object**  
Kite: under the table on the right.  
**Activity**  
Food eaten with fingers: pizza, French fries, egg rolls, sushi
- **Practice**  
**Activity Bank:** Write the numbers, How do you eat it?, Draw and label  
**Flashcard Game Bank:** Card collector

## Topic 31 Bears Go Camping

- **Answer key**  
**Hidden object**  
Quilt: inside the tent on the left.  
**Activity**  
Nineteen animals in total: thirteen bears, two deer, two mice, one rabbit, one bird
- **Practice**  
**Activity Bank:** Mimes, Throw the dice, Crosswords  
**Flashcard Game Bank:** Flash

## Topic 32 Playtime in the Park

- **Notes**  
The things not listed that the children are doing, from top left to right are: climbing on the jungle gym, playing on the seesaw, playing on the slide and playing on the swings.
- **Answer key**  
**Hidden object**  
Elephant: in the trees.  
**Activity**  
Basketball: three children  
Baseball: six children
- **TPR**  
Throw the baseball. Pick up the bat.  
Hit the ball. Run! Catch the ball.

- **Practice**  
**Activity Bank:** Mimes, Write the numbers, Surveys (*What do you like to play in the park?*)  
**Flashcard Game Bank:** Dice act

## Topic 33 African Plains

- **Notes**  
This topic focuses on the plains of central and southern Africa. They are also known as grasslands or savannah. The **flamingo** and the **ostrich** have a **beak**. The **elephant** has **tusks** and a **trunk**. The **rhinoceros**, the **buffalo** and the **giraffe** have **horns**. The **cheetah** is the fastest land mammal. The **giraffe** is the tallest land mammal. The **elephant** is the largest land mammal and is endangered. The **hippopotamus** is also called a hippo. It is endangered. The **rhinoceros** is also called a rhino. It is endangered.
- **Answer key**  
**Hidden object**  
Star: near the acacia tree.
- **Activity**  
The cheetah is the fastest runner.  
The giraffe is the tallest animal.
- **Practice**  
**Activity Bank:** A or an?, Word web, Recall the words  
**Flashcard Game Bank:** Spell it

## Topic 34 Tropical Rainforests

- **Notes**  
This topic focuses on the Amazon tropical rainforest and South East Asian tropical rainforests. Animals with **fangs** are the **jaguar**, **tiger**, **tarantula** and **snake** (cobra). Animals with **feathers** are the **toucan** and the **parrot**. The **canopy** is the uppermost layer of the rainforest. The tall trees have bare trunks with branches only at the top. The branches form a roof-like layer, preventing the sunlight from reaching the forest floor. When you fly over the rainforest in an airplane, all you can see is the canopy.  
**Orangutang** means "old man of the forest" in Malay. It spends most of its life in trees and is the largest tree mammal in the world. It is endangered. The **tiger** is the largest cat. It is endangered. The **rafflesia** plant produces the biggest flower in the world, which can measure one meter across. It smells like rotting meat to attract flies that pollinate it. **Bamboo** is part of the grass family. There are over 840 species, some growing to more than 40 meters and as much as one meter a day. The **jaguar** is a good swimmer and can attract fish by using its tail as a lure. It is endangered. One poison arrow **frog** can produce enough poison to kill 50 people. The **piranha** feeds on the flesh of animals (and sometimes

people!) The **tarantula** is the largest spider in the world. It can catch and eat small birds or mice. There are more than 330 varieties of **parrots**; the largest are called macaws.

- **Answer key**

- **Hidden object**

- Ant: on the bamboo.

- **Activity**

- Animals that can fly: toucan, parrot

- Animals that can climb: monkey, orangutang, jaguar, tiger, snake, frog, tarantula, parrot

- **Practice**

- **Activity Bank:** Lotto, Puzzles, Draw and write

- **Flashcard Game Bank:** Find the joker

## Topic 35 Polar Regions

- **Notes**

This topic focuses on the Arctic Circle in the north and the Antarctic Circle in the south. All the animals can swim. Animals with antlers are the **reindeer** and the **moose**. **Antlers** are bony growths that grow back every year. Only the male has antlers. Animals with **flippers** are the **walrus**, **seal**, **whale** and **penguin**. A **skidoo** is a modern form of polar transport. An **iceberg** is a huge chunk of ice floating on the ocean; only 10% shows above the water. The **blue whale** is around 20 meters long. It is the largest animal ever to live on the earth. It is endangered. The North Pole is all frozen ocean; there is no land. In the winter, the temperature can get as low as minus 50 degrees Celsius. The native peoples of the Arctic are the Inuit in America and the Lapps in Europe. The **husky** is a very strong and hardy dog used by the Inuit to pull sledges. It can live in temperatures as low as minus 45 degrees Celsius. The **reindeer** is traditionally used by the Lapps to pull sleds. In Christmas lore, reindeers are used to pull Santa Claus' sleigh. The **arctic fox** turns white only during the winter. On some nights, you can see the **Northern Lights**. They are colorful lights flickering across the sky. The ice covering Antarctica is one and one half times the size of the United States. Winter temperatures can get as low as minus 70 degrees Celsius. There are no native peoples in Antarctica; there are only scientists and tourists. **Penguins** live only at the South Pole.

- **Answer key**

- **Hidden object**

- Key: in the reindeer's antlers.

- **Activity**

- Animals that live on land: polar bear, husky, arctic fox, reindeer, moose

- Animals that live on land and in water: penguin, seal, puffin, walrus

- **Practice**

- **Activity Bank:** Chains, Write the number, Throw

the dice

**Flashcard Game Bank:** Photo memory

## Topic 36 Australian Outback

- **Notes**

This topic focuses on the outback, which is the dry, desert landscape of the Australian interior; and also on other areas of wilderness in Australia. Animals with a **pouch** are the **kangaroo**, **koala** and **wombat**. They are called marsupials. The largest **kangaroos** can move as far as ten meters in one hop. The **koala** lives in **gum trees**, feeds on eucalyptus leaves and sleeps eighteen hours a day. The **wombat** digs burrows in the ground. It can survive as long as seventeen years without taking a drink. A **dingo** is a wild dog. The **platypus** is a mammal, but it lays eggs. It has fur and claws, but also webbed feet and a bill like a duck. It is the only mammal that is poisonous. The **emu** is a giant bird, it can't fly but can run 30 miles an hour. A **boomerang** is an aboriginal hunting tool designed so it returns to the thrower. A **didgeridoo** is a large aboriginal trumpet made of bamboo or other wood.

- **Answer key**

- **Hidden object**

- Ice cream cone: behind the koala.

- **Activity**

- k words in alphabetical order: kangaroo, koala, kookaburra

- **Practice**

- **Activity Bank:** Writing lotto, Point and say, Scramble

- **Flashcard Game Bank:** Card chase

## Topic 37 Deserts

- **Notes**

This topic focuses on the Sahara desert in Africa and the North American deserts: Great Basin, Mojave, Sonoran and Chihuahuan. Animals with **scales** are the **rattlesnake** and the **lizard**. Animals with **claws** are the **vulture**, **eagle**, **bat**, and **scorpion**. A **gazelle** can survive without ever having to drink water. The **rattlesnake** rattles its tail to warn larger animals it is there. The tail of a **scorpion** has a sting at the end.

- **Answer key**

- **Hidden object**

- Egg: behind the eagle.

- **Activity**

- Odd-one-out: cactus is a plant; lizard has scales

- **Practice**

- **Activity Bank:** Throw the dice, Say and point, Chains

- **Flashcard Game Bank:** Swat

## Topic 38 The Schoolyard

- **Answer key**  
**Hidden object**  
Umbrella: in the classroom.  
**Activity**  
There are eight rooms, including two restrooms.
- **TPR**  
Get on the school bus. Sit down. Stand up.  
Get off the bus.
- **Practice**  
**Activity Bank:** Mimes, Point and say,  
Draw and label  
**Flashcard Game Bank:** Rock, paper, scissors race

## Topic 39 School Day

- **Notes**  
P.E. is short for physical education.
- **Answer key**  
**Hidden object**  
Queen: in the art class.  
**Activity**  
Classrooms in alphabetical order: art class,  
computer class, English class, math class, music  
class, P.E., science class
- **TPR**  
Walk to the whiteboard. Clean the board.  
Write the date. Go back to your desk.
- **Practice**  
**Activity Bank:** Identification, Writing lotto, Say  
and write  
**Flashcard Game Bank:** Concentration

## School Bag Search

- **Answer key**  
**Hidden object**  
Panda: on the colored pencils box.  
**Activities**  
1. Something beginning with e: eraser
- **TPR**  
Open your pencil case. Take out a ruler.  
Pick up a pencil. Draw a line in your notebook.
- **Practice**  
**Activity Bank:** Feely bag, Identification, Scramble  
**Flashcard Game Bank:** Telephone line

## Sports Day

- **Notes**  
The races being done by the children include: a  
sack race, a three-legged race, a running race and  
a relay race with a soccer ball around cones.  
Other children are stretching to warm up for a

race. Three children are on the podium to receive  
their ribbons for **first**, **second** and **third** place.  
The cheerleaders have pom-poms. The teacher  
standing next to the scoring table is holding a  
megaphone. The teacher at the starting line has a  
starting gun. The teacher near the finish line is  
looking at a stopwatch.

- **Answer key**  
**Hidden object**  
Lion: in the stands.  
**Activity**  
Sack race: four children  
Three-legged race: eight children
- **TPR**  
Go to the starting line. Get ready, set, go!  
Cross the finish line. Cheer!
- **Practice**  
**Activity Bank:** Mimes, Writing lotto,  
Who was first?  
**Flashcard Game Bank:** Photo memory

## Topic 42 Animal Orchestra

- **Notes**  
The animals from top left to right are:  
lion – **guitar**, octopus – **harp**,  
horse – **keyboard**, polar bear – **piano**,  
giraffe – **triangle**, elephant – **tambourine**, walrus  
– **saxophone**, kangaroo – **recorder**, zebra –  
**trumpet**, panda – **trombone**, crocodile – **violin**,  
sheep – **flute**,  
gorilla – **bongo drums**,  
orangutang – **xylophone**,  
hippopotamus – **cymbals**,  
snake – **conductor**.
- **Answer key**  
**Hidden object**  
Banana: in the piano.  
**Activity**  
Gorilla: bongo drums  
Horse: keyboard
- **TPR**  
Blow the trumpet. Beat the bongo drums.  
Play the violin. Shake the tambourine.
- **Practice**  
**Activity Bank:** Match it, Really? Really!,  
Crosswords  
**Flashcard Game Bank:** Dice act

## Topic 43 Pets

- **Notes**  
In English, **dogs** say *bow-wow* or *woof-woof*, **cats**  
say *meow*, **rabbits** don't say anything, but they  
twitch their noses, **birds** say  
*tweet-tweet* or *chirp-chirp*, and **goldfish** open  
and close their mouths without making a sound.



- **Answer key**

- Hidden object**

- Flower: in the rabbit's food.

- Activity**

- Cage: rabbit, guinea pig, hamster, bird

- Tank: goldfish, turtle, gecko

- Basket: cat, dog, kitten, puppy

- **Practice**

- Activity Bank:** What does it say?,

- Throw the dice, Which one?

- Flashcard Game Bank:** Tell me why

## Topic 44 Bugs and Little Creatures

- **Notes**

Bug is another word for insect. Insects have a body in three parts and six legs. Only some of the creatures on this page are insects. Creatures with no legs are **worm** and **snail**. Bugs with six legs are the **cicada**, **beetle**, **ant**, **butterfly**, **ladybug**, **mosquito**, **fly**, **grasshopper**, **dragonfly** and **bee**. The creature with eight legs is a **spider**. The creatures with many legs are **centipede** and **caterpillar**.

- **Answer key**

- Hidden object**

- Apple: behind the cicada.

- Activity**

- Creatures that can fly in alphabetical order: bee, beetle, butterfly, cicada, dragonfly, fly, ladybug, mosquito

- **Practice**

- Activity Bank:** Bombs, Say and point, Write and draw

- Flashcard Game Bank:** Swat

## Topic 45 Dress Up

- **Notes**

The setting is backstage at the theater. The children are changing their clothes for the next scene of a play. Both boys and girls can wear a shirt, but only girls wear a blouse.

- **Answer key**

- Hidden object**

- Guitar: behind the clothes trunk.

- Activities**

- Three flowered clothes: tie, dress, apron

- Three checked clothes: blouse, tie, shirt

- **Practice**

- Activity Bank:** Which one?, Fashion show, Crosswords

- Flashcard Game Bank:** Find the joker

## Topic 46 My Favorite Clothes

- **Answer key**

- Hidden object**

- Ladybug: on the waving girl's hair clip.

- Activities**

- 1. Odd-one-out: watch, you wear it on your arm; sandals, you don't wear them in the rain

- **TPR**

- Put on your raincoat. Put on your boots.

- Open your umbrella. Jump in a puddle!

- **Practice**

- Activity Bank:** Remember, Surveys (*What's your favorite outfit?*), Compliments

- Flashcard Game Bank:** Spell it

## Topic 47 At the Doctor's

- **Answer key**

- Hidden object**

- X-ray: under the counter.

- Activity**

- e words in alphabetical order: ear, elbow, eye

- **TPR**

- Touch your head. Bend your knees.

- Open your arms. Touch your stomach.

- **Practice**

- Activity Bank:** Do as I say, Write the numbers, Word web

- Flashcard Game Bank:** Rock, paper, scissors race

## Topic 48 At the Vet's

- **Notes**

- The plural of foot is feet. The singular of teeth is tooth.

- **Answer key**

- Hidden object**

- Jellyfish: in the tiger's cage.

- Activities**

- 2. Hair: fur

- Hand: paw

- Foot: paw

- **Practice**

- Activity Bank:** Tiger, Write and draw, Point and write

- Flashcard Game Bank:** Card chase

## Topic 49 The Fairground

- **Notes**

- The performers are walking in a parade. The **tall juggler** is walking on stilts. The **short juggler** is juggling balls. The **beautiful dancer** is doing ballet steps. The **large clown** is clapping. The **sad**

clown is crying. A bucket of water has accidentally fallen on the **strongman** and now he is **wet**. The **happy clown** is laughing at the **acrobat** who has slipped on a banana peel and landed in the dirt.

- **Answer key**

- **Hidden object**

- Van: behind the cotton candy stall.

- **Activities**

- 1. Happy: two jugglers, two clowns, the dancer  
Not happy: one clown, the strongman, the acrobat

- **Practice**

- **Activity Bank:** Mimes, Chains, Which one?

- **Flashcard Game Bank:** Flash

## **Topic 50** Growing Up

- **Notes**

The animals from top left to right are:  
hippopotamus – patient, crocodile – **dentist**,  
zebra – **doctor**, gorilla – patient,  
bear – **nurse**, giraffe – **cook**, penguin – **waitress**,  
penguin – **waiter**, elephants – guests, flamingo,  
panda, cat and monkey – **police officers**,  
polar bears – **firefighters**, whale – **teacher**,  
dolphin, seahorse and turtle – students,  
octopus – **painter**, orangutang – **carpenter**,  
kangaroo – customer, koala – **mail carrier**.

- **Answer key**

- **Hidden object**

- Xylophone: in the police car.

- **Activities**

- 1. Flamingo: police officer  
Crocodile: dentist
    - 2. Bag: mail carrier  
Paintbrush: painter

- **Practice**

- **Activity Bank:** Really? Really!,

- Last sound /er/, Crosswords

- **Flashcard Game Bank:** Card collector

# Board Game 1

## Topics 1, 2

### How to play

Students play in pairs. Each student has eight code words to break. Students take turns to roll the die. If they roll a three, four, five or six, they can choose a corresponding three, four, five or six-letter code word to break. If they roll a one or a two, they miss a turn. The aim is to be the first to break all eight codes. He/she can then progress to the twelve-letter code word, using two dice. The winner is the student who rolls two sixes and breaks the twelve-letter code word first.



1-a 2-b 3-c 4-d 5-e 6-f 7-g 8-h 9-i 10-j 11-k 12-l 13-m 14-n 15-o  
 16-p 17-q 18-r 19-s 20-t u v w x y z

	Student 1	Student 2																									
1.	<table border="1"><tr><td>8</td><td>1</td><td>20</td></tr><tr><td></td><td></td><td></td></tr></table>	8	1	20				<table border="1"><tr><td>4</td><td>15</td><td>7</td></tr><tr><td></td><td></td><td></td></tr></table>	4	15	7																
8	1	20																									
4	15	7																									
2.	<table border="1"><tr><td>11</td><td>5</td><td></td></tr><tr><td></td><td></td><td></td></tr></table>	11	5					<table border="1"><tr><td></td><td>1</td><td>14</td></tr><tr><td></td><td></td><td></td></tr></table>		1	14																
11	5																										
	1	14																									
3.	<table border="1"><tr><td>2</td><td>9</td><td>18</td><td>4</td></tr><tr><td></td><td></td><td></td><td></td></tr></table>	2	9	18	4					<table border="1"><tr><td>6</td><td>9</td><td>19</td><td>8</td></tr><tr><td></td><td></td><td></td><td></td></tr></table>	6	9	19	8													
2	9	18	4																								
6	9	19	8																								
4.	<table border="1"><tr><td>19</td><td>20</td><td>1</td><td>18</td></tr><tr><td></td><td></td><td></td><td></td></tr></table>	19	20	1	18					<table border="1"><tr><td>4</td><td></td><td>3</td><td>11</td></tr><tr><td></td><td></td><td></td><td></td></tr></table>	4		3	11													
19	20	1	18																								
4		3	11																								
5.	<table border="1"><tr><td>17</td><td></td><td>9</td><td>12</td><td>20</td></tr><tr><td></td><td></td><td></td><td></td><td></td></tr></table>	17		9	12	20						<table border="1"><tr><td></td><td>5</td><td>2</td><td>18</td><td>1</td></tr><tr><td></td><td></td><td></td><td></td><td></td></tr></table>		5	2	18	1										
17		9	12	20																							
	5	2	18	1																							
6.	<table border="1"><tr><td>8</td><td>15</td><td>18</td><td>19</td><td>5</td></tr><tr><td></td><td></td><td></td><td></td><td></td></tr></table>	8	15	18	19	5						<table border="1"><tr><td></td><td>1</td><td>20</td><td>3</td><td>8</td></tr><tr><td></td><td></td><td></td><td></td><td></td></tr></table>		1	20	3	8										
8	15	18	19	5																							
	1	20	3	8																							
7.	<table border="1"><tr><td>6</td><td>12</td><td>15</td><td></td><td>5</td><td>18</td></tr><tr><td></td><td></td><td></td><td></td><td></td><td></td></tr></table>	6	12	15		5	18							<table border="1"><tr><td>15</td><td>18</td><td>1</td><td>14</td><td>7</td><td>5</td></tr><tr><td></td><td></td><td></td><td></td><td></td><td></td></tr></table>	15	18	1	14	7	5							
6	12	15		5	18																						
15	18	1	14	7	5																						
8.	<table border="1"><tr><td></td><td>9</td><td>15</td><td>12</td><td>9</td><td>14</td></tr><tr><td></td><td></td><td></td><td></td><td></td><td></td></tr></table>		9	15	12	9	14							<table border="1"><tr><td>18</td><td>15</td><td>3</td><td>11</td><td>5</td><td>20</td></tr><tr><td></td><td></td><td></td><td></td><td></td><td></td></tr></table>	18	15	3	11	5	20							
	9	15	12	9	14																						
18	15	3	11	5	20																						
	<table border="1"><tr><td>9</td><td>3</td><td>5</td></tr><tr><td></td><td></td><td></td></tr></table>	9	3	5				<table border="1"><tr><td>3</td><td>18</td><td>5</td><td>1</td><td>13</td></tr><tr><td></td><td></td><td></td><td></td><td></td></tr></table>	3	18	5	1	13						<table border="1"><tr><td>3</td><td>15</td><td>14</td><td>5</td></tr><tr><td></td><td></td><td></td><td></td></tr></table>	3	15	14	5				
9	3	5																									
3	18	5	1	13																							
3	15	14	5																								

**FINISH**

# Board Game 2

## Topics 3, 4

### How to play

Students play in pairs. Each student uses a different colored pencil. They take turns to draw a side of any square. The aim is to block the partner's squares and collect as many squares as possible. The student who completes a square names the item inside and writes his/her name in the square. The winner is the student with the most squares.

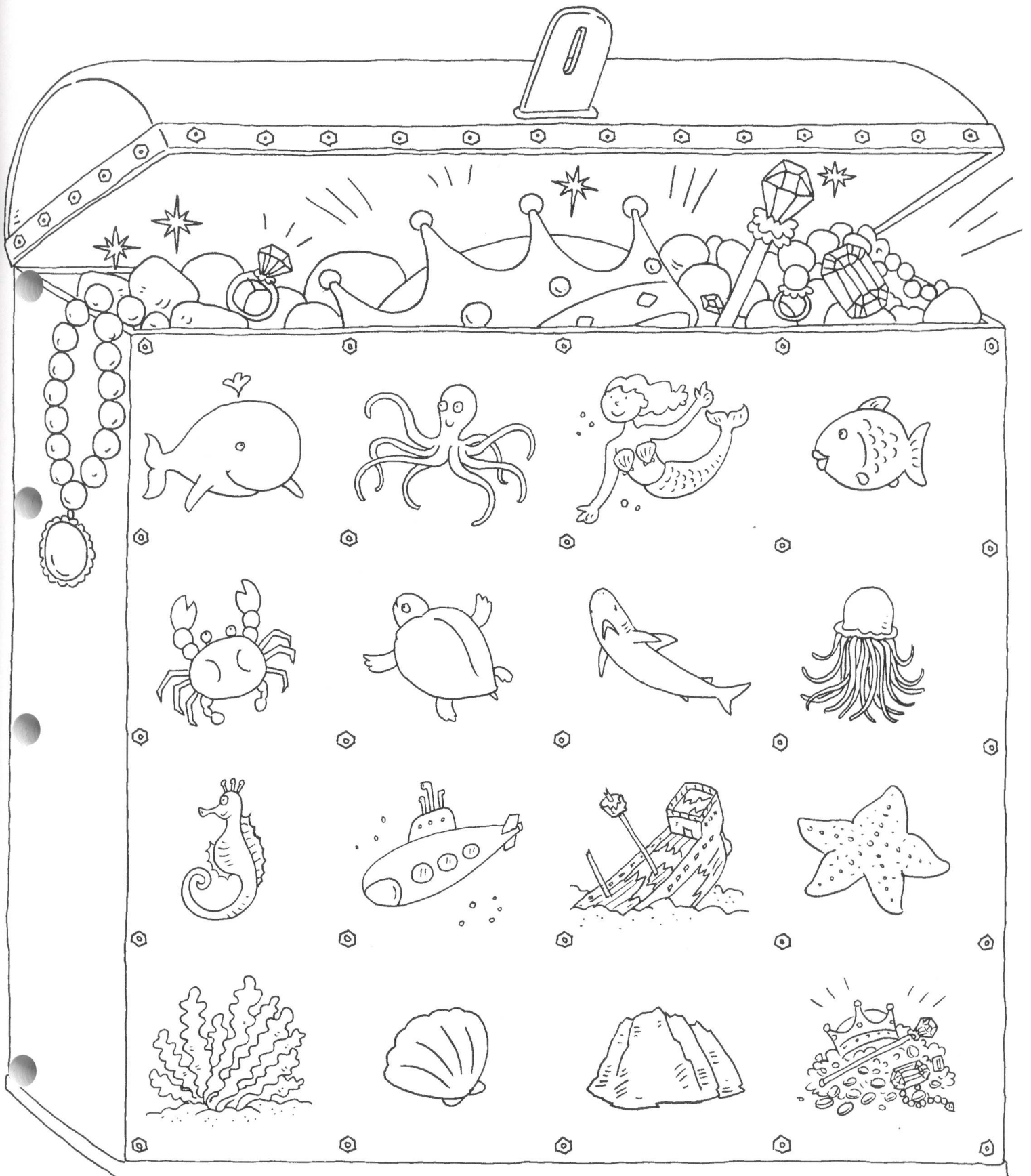

# Board Game 3

## Topics 5, 6

### How to play

Two to four players place their counters on the start. They take turns to roll the die and move the corresponding number of spaces on the board. When a student lands on a square, he/she must answer the question by referring to the dictionary pages, or follow the instructions. The winner is the first student to make it to the finish line.



<p><b>START</b></p>	<p>1. Which vegetable is singing?</p>	<p>2. What's the orange doing?</p>	<p>3. Is the pumpkin dancing?</p>
<p>13. Is the strawberry doing a headstand?</p>	<p>14. Name two red vegetables.</p>	<p>15. Which fruit is doing a cartwheel?</p>	<p><b>MISS A TURN!</b></p>
<p>12. Which fruit is doing a somersault?</p>	<p><b>FINISH</b></p>	<p><b>GO BACK 3 SPACES!</b></p>	<p>5. What's the corn doing?</p>
<p><b>MISS A TURN!</b></p>	<p>18. Name a long fruit and a long vegetable.</p>	<p>17. Is the onion playing the drums?</p>	<p>6. Name two yellow fruits.</p>
<p>10. Is the chili dancing?</p>	<p>9. What's the cucumber doing?</p>	<p>8. <b>MOVE 2 SPACES!</b></p>	<p>7. Is the kiwi doing a handstand?</p>

# Board Game 4

## Topics 7, 8

### How to play

In pairs, students cut out the cards and place them upside down in a pile. S1 takes the top card and S2 asks, *Where are you going?* S1 looks at his/her card and names the place where the item on the card can be found. For example, if the card has a book on it, he/she replies, *To the library.* He/she must then try to draw a line through the maze to the destination without taking the pencil off the paper. If successful, he/she can keep the card. If not, the card goes to the bottom of the pile. The winner is the student with the most cards.

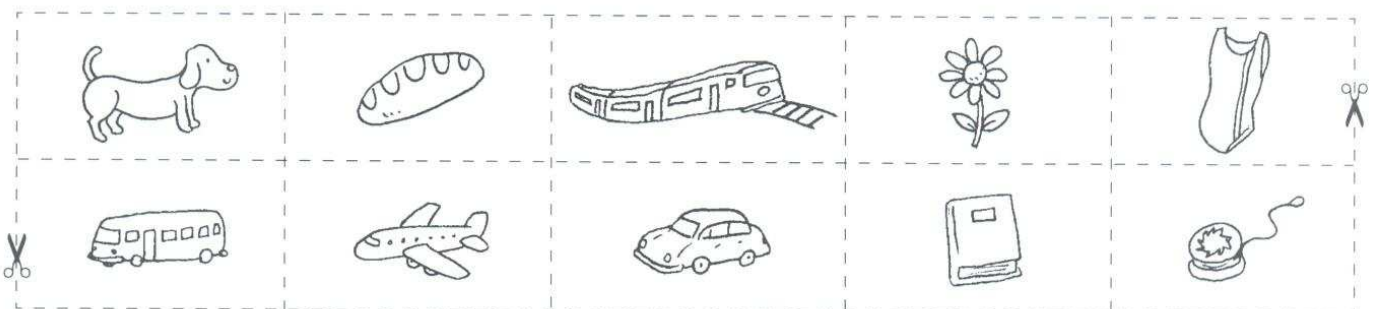
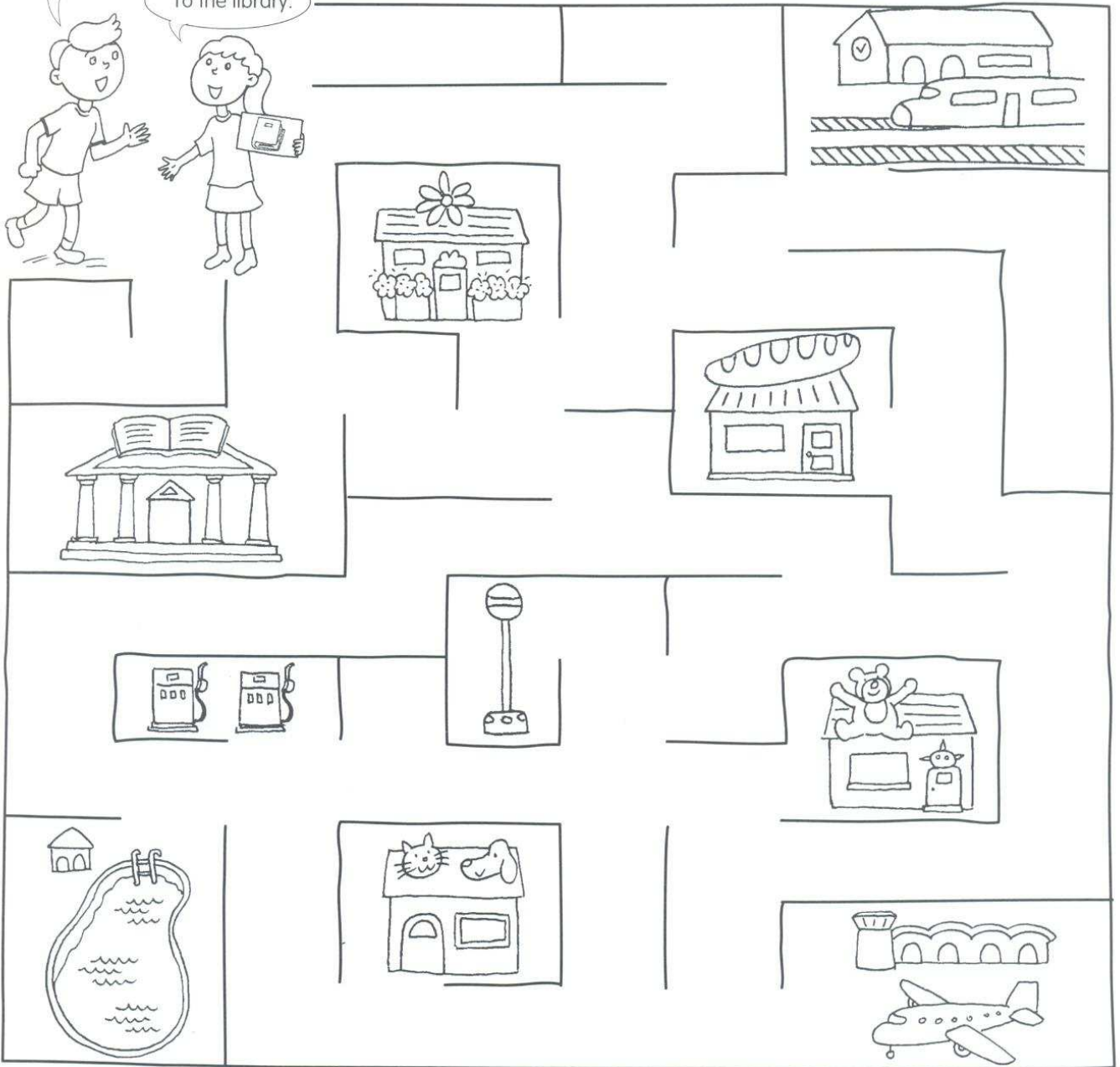

# Board Game 5

## Topic 9

### How to play

In pairs, students put number cards 1–18 in a bag (from the Flashcard Photocopiables). They take turns to draw a number and go to the corresponding number on the family tree. They must either unscramble a family word, or color the tree as indicated. The game is over when all the words have been successfully unscrambled and the tree has been colored.

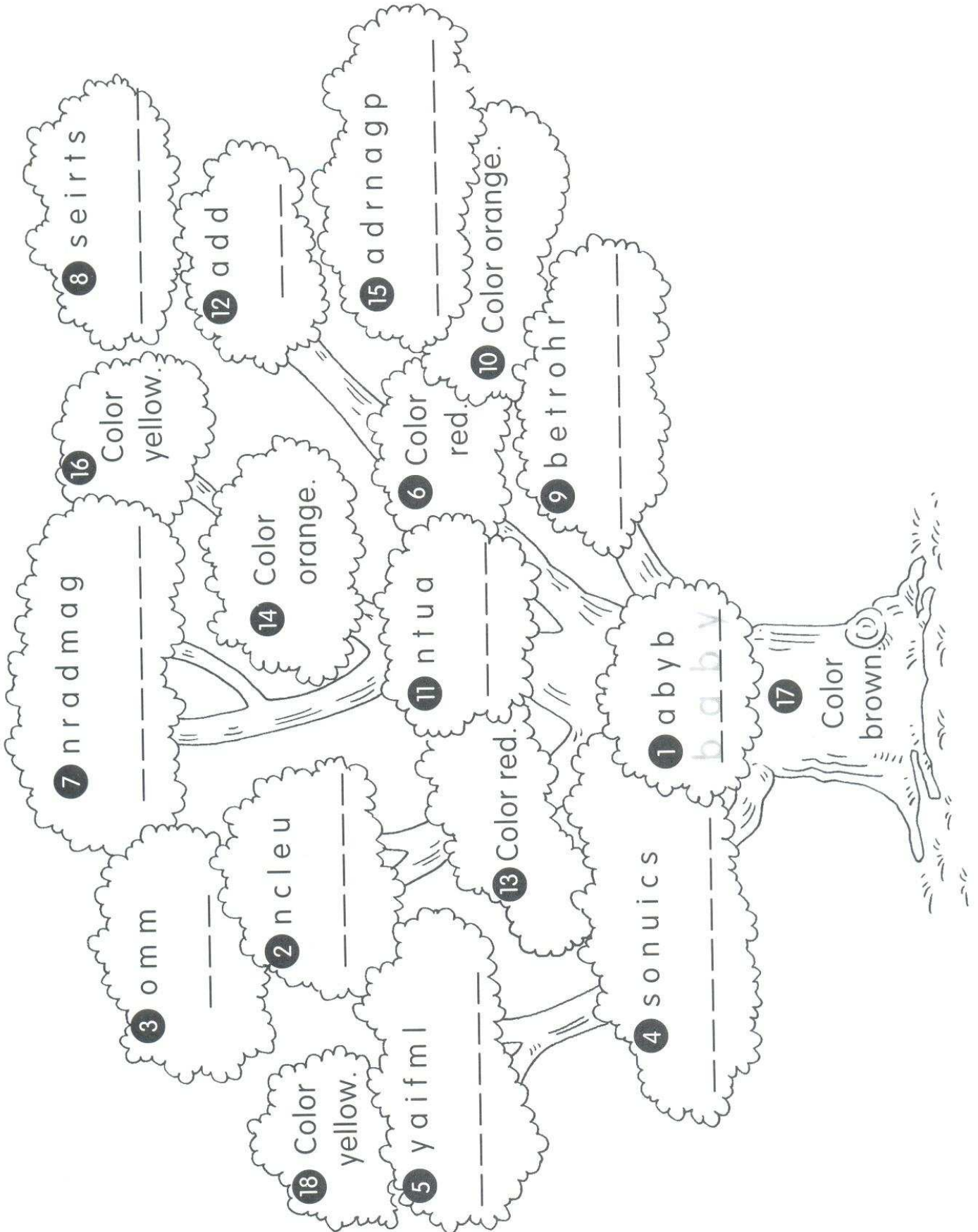

# Board Game 6

## Topics 10, 11, 12

### How to play

In pairs, students take turns to roll two dice. They look at the corresponding number on the board and must try to identify the item. If they are successful, they can write their score on the score sheet. Kitchen items score one point and bathroom items score two points. Each item can only be identified once. The winner is the student with the most points.

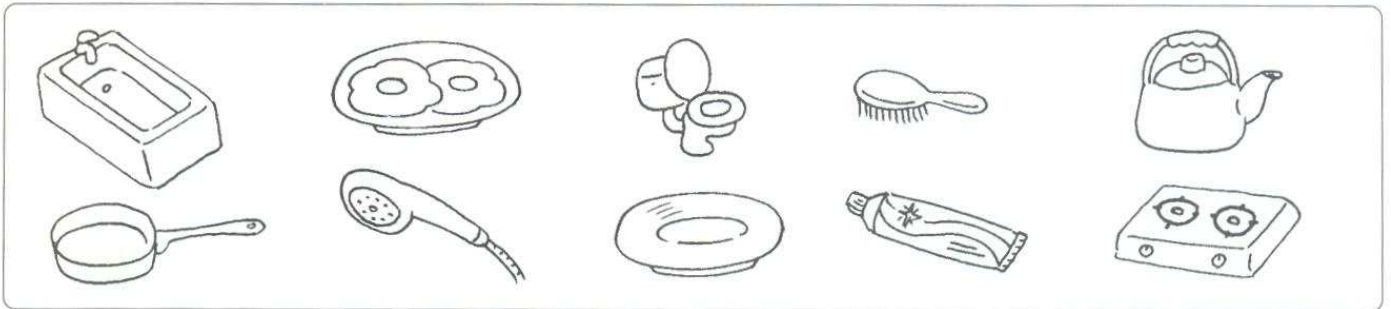

Kitchen item = 1 point  
Bathroom item = 2 points

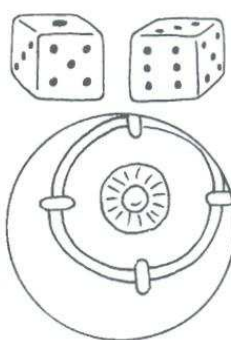
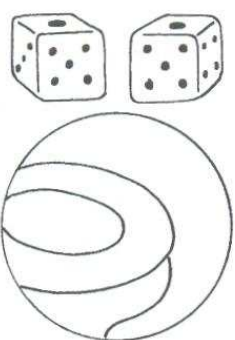
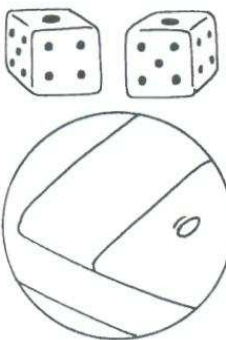
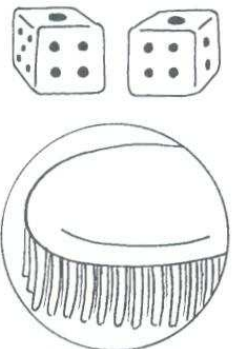
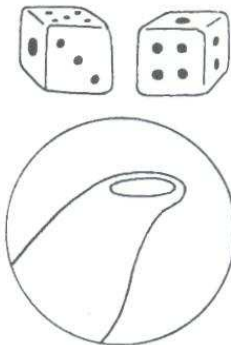
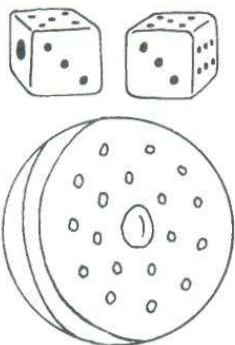
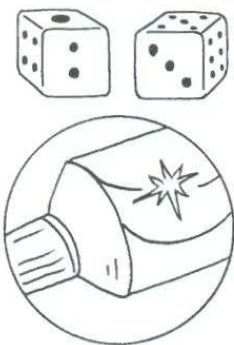
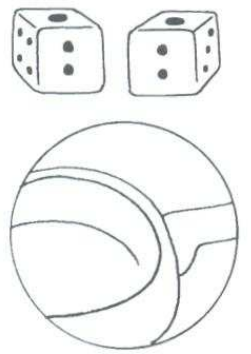
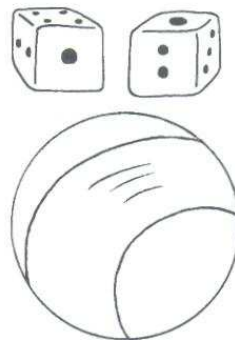
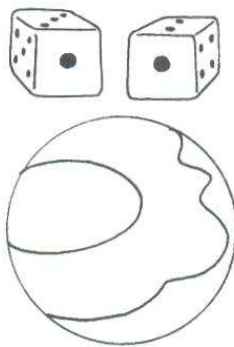

### SCORE

	Student 1	Student 2
TOTAL =		TOTAL =



# Board Game 7

## Topics 13, 14

### How to play

In pairs, students take turns to roll the die. Each number, 1–6, represents the quantity of a particular item in the picture. Students race against each other to find the item corresponding to the number and call it out. Play until all numbers have been called.

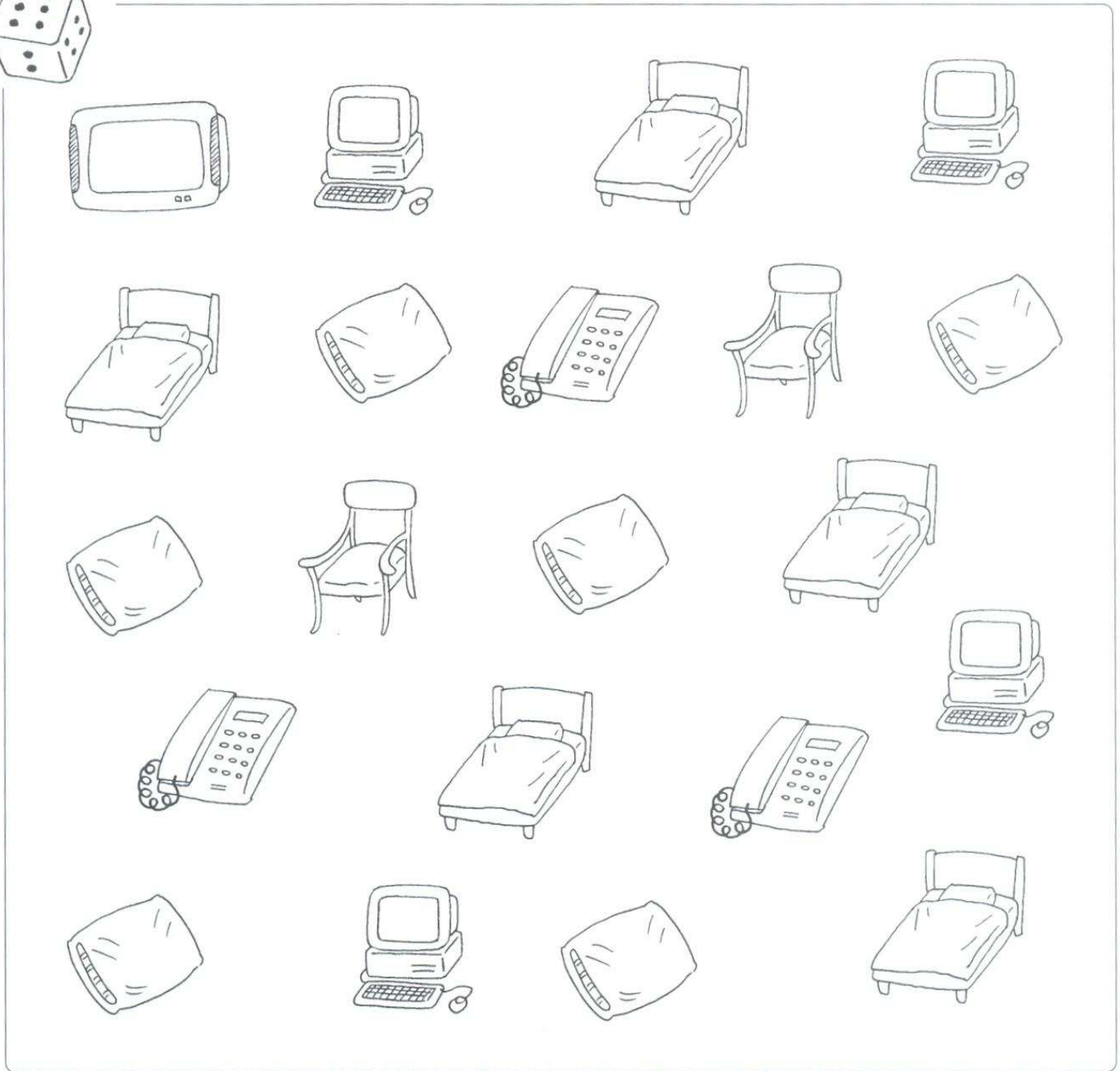

Student 1		Student 2	
Number	Item	Number	Item

# Board Game 8

## Topic 15

### How to play

Students cut out the space items and place nine of them on their bingo boards. They play in groups or as a class. The teacher or a student calls out the items randomly. The first student to check off a horizontal, vertical or diagonal line on their board calls out, *Blast off!* and is the winner.

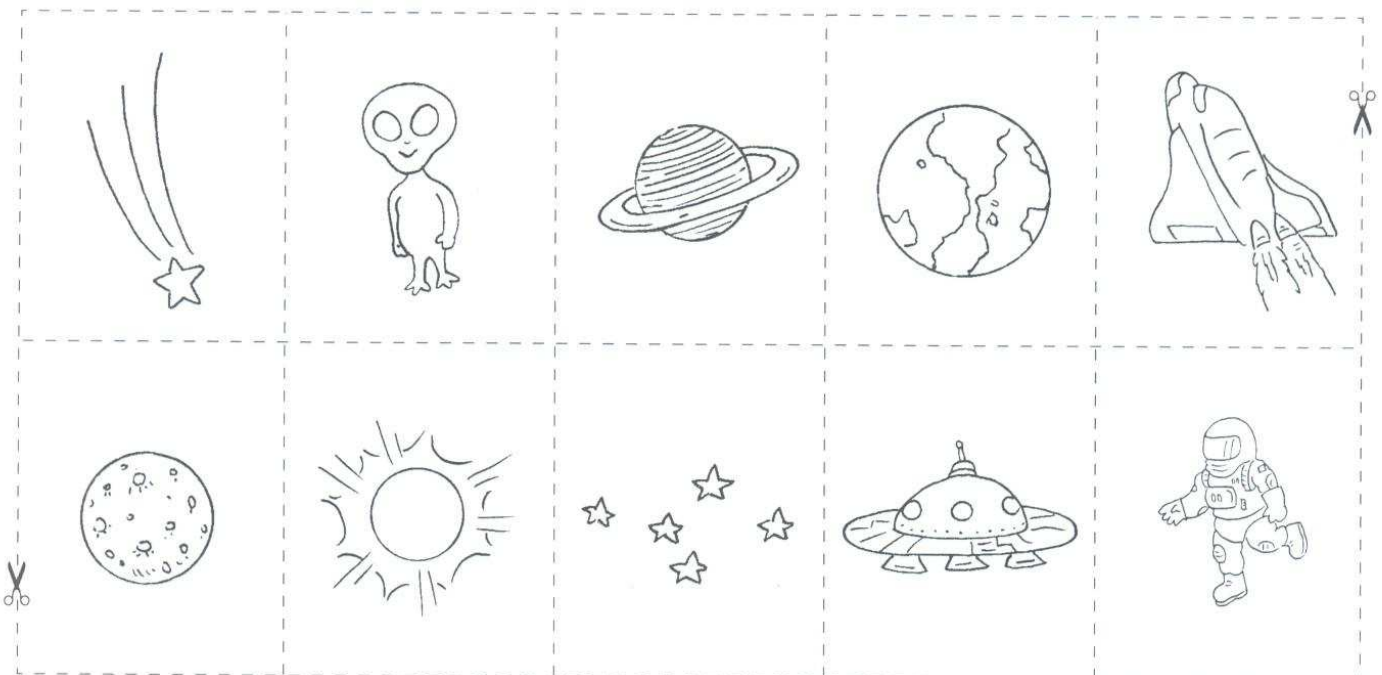
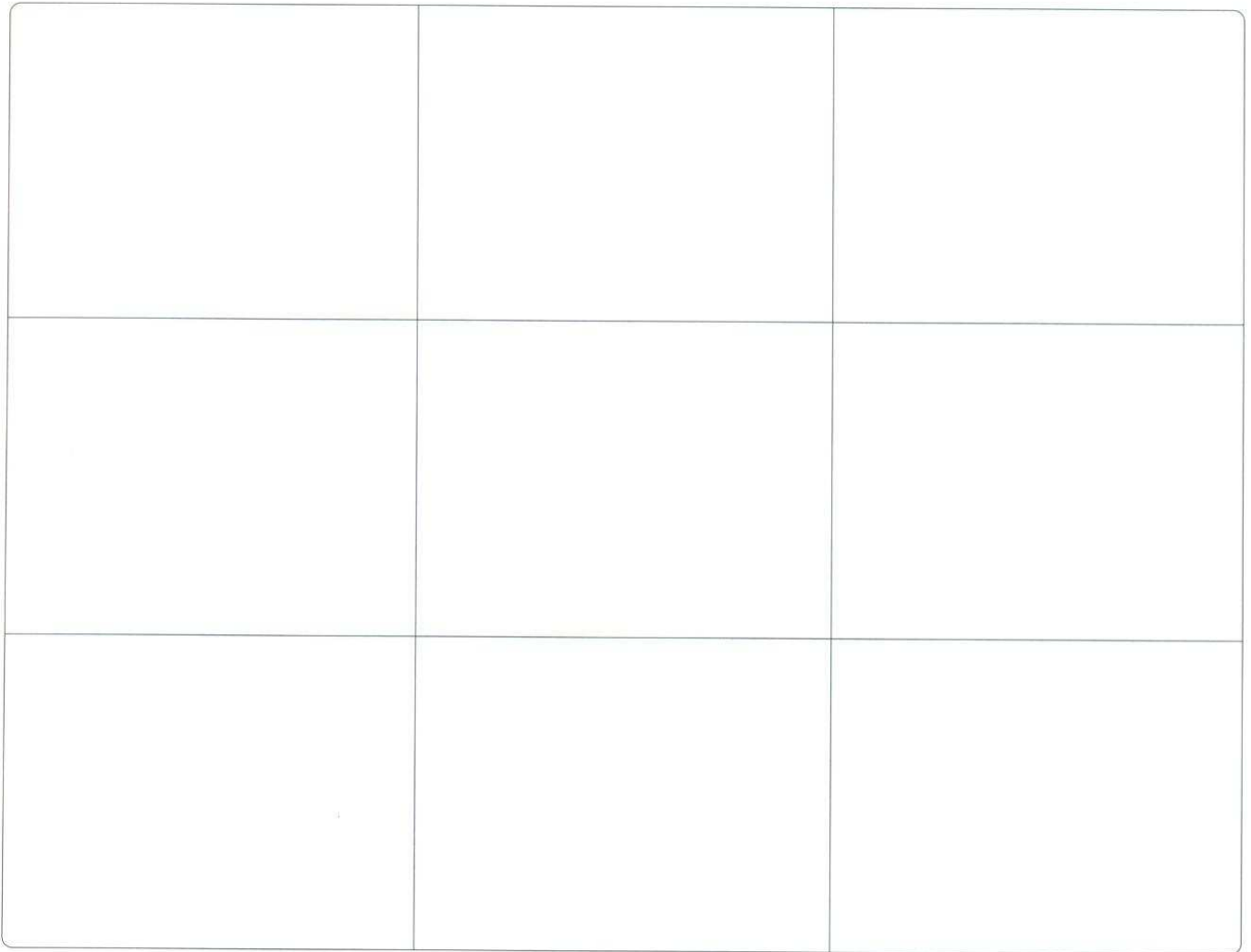

# Board Game 9

## Topic 16

### How to play

Students play in pairs. Each student places a counter at the start. They take turns to flip a coin and move around the board. They can move one space for heads and two spaces for tails. When they land on a weather symbol, they must say what the weather's like, e.g. *It's foggy*. The winner is the first student to complete his/her weather checklist by landing on every type of weather condition.

The board game consists of a circular path of weather symbols starting from a 'START' cloud. The path includes: a sun, a cloud with rain, a cloud with lightning, a cloud with snow, a cloud with wind, a sun, a cloud with lightning, a cloud with rain, a cloud with snow, a cloud with wind, a sun, a cloud with lightning, a cloud with rain, a cloud with snow, and a cloud with wind. Two world maps are placed in the center of the board. To the right of the board are two weather checklists, one for Student 1 and one for Student 2. Each checklist is a 6x2 grid with weather symbols in the first column and empty boxes in the second column.

Student 2		

Student 1		

# Board Game 10

## Topics 17, 19

### How to play

In pairs, students cut out the cards and place them face up. They are given one minute to memorize the quantities of the items on the cards. The cards are then placed in a pile face down. Pairs take turns to pick up a card and test their partner's memory, e.g. S1 asks, *How many squirrels are there?* S2 replies, *Three!* S1 congratulates S2, *Yes, that's right!* and S2 gets to keep the card. If the answer is incorrect, S1 says, *Sorry, try again next time.* The card is placed at the bottom of the pile. The winner is the student with the most cards.

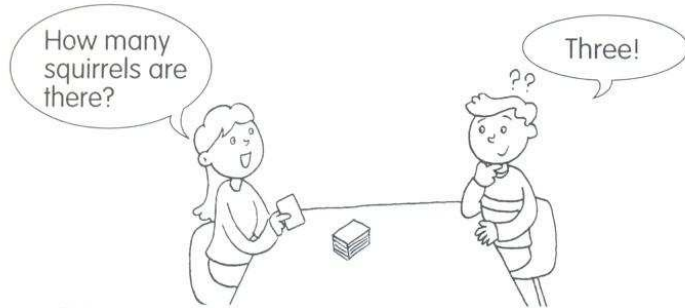

squirrels

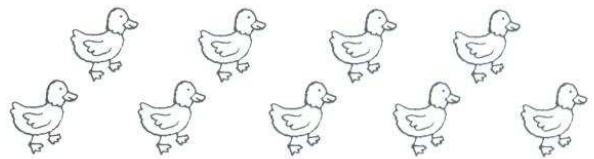

ducklings

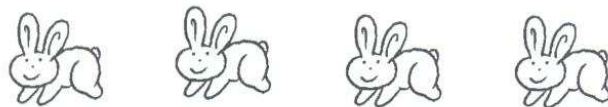

rabbits

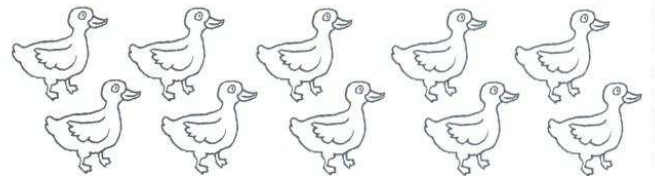

ducks

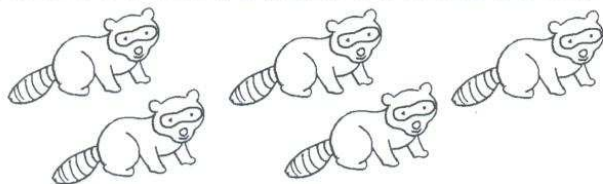

raccoons

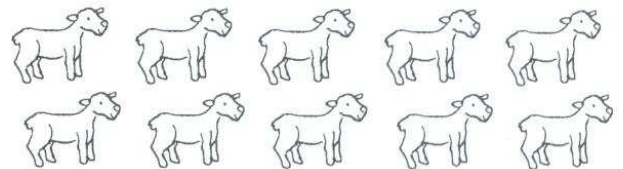

lambs

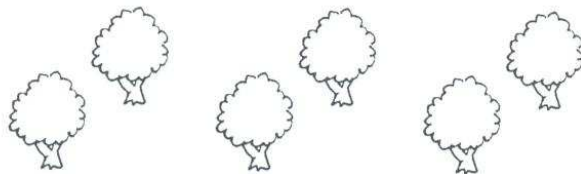

trees

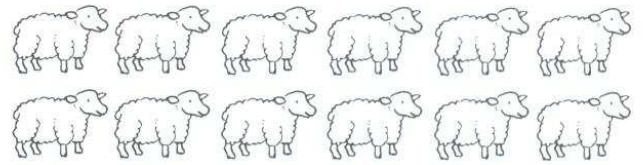

sheep

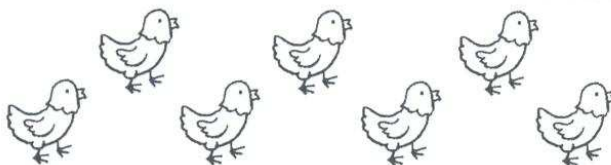

chicks

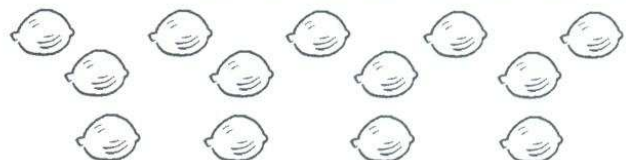

nuts

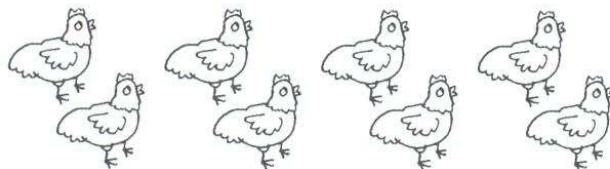

hens



acorns

# Board Game 11

## Topics 18, 20

### How to play

In pairs, students try and copy the pyramid by connecting the dots without taking their pencils off the paper and without going over any lines twice. Once they can go no further, each student says how many triangles he/she has drawn and what the items are inside the triangles. After S1 names an item, S2 must say whether it is a summer item or a winter item.

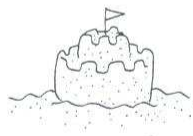
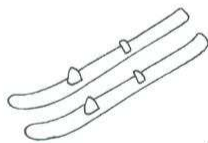
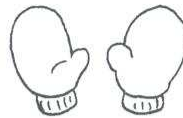
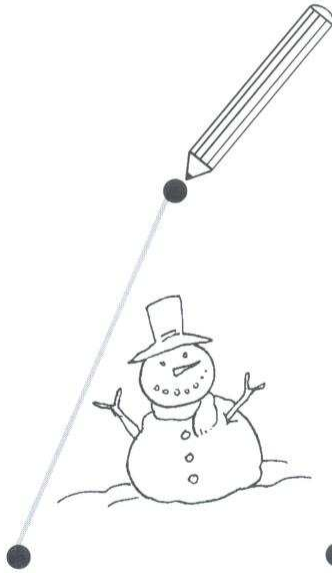
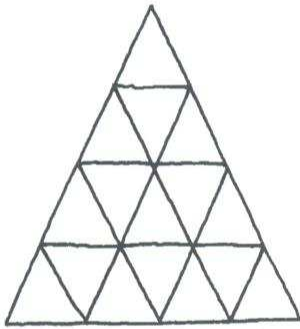

# Board Game 12

## Topics 21, 22, 23

### How to play

Students play in pairs. Each student has a different colored pencil and chooses a triangle, circle or star to begin the game. They take turns to progress through the maze choosing the same shape and only words that begin with the same letter. As they land on a shape, they name it, e.g. *Circle, April*. If they can't move forward, they must start at the beginning again. The winner is the student to make it through the maze to the finish.



**START**

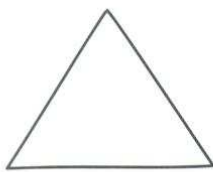

September

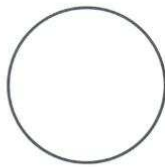

April



Tuesday

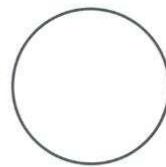

March



July

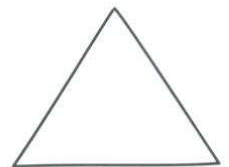

December



June

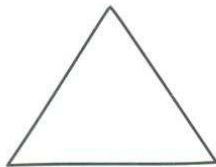

Wednesday

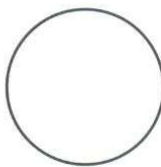

May

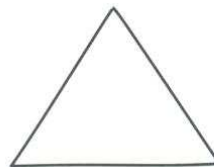

Saturday

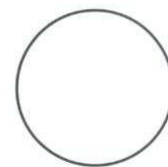

August



Thursday



October



January

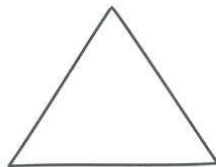

Sunday



November

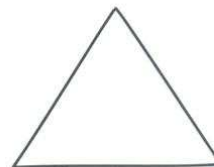

Friday



Monday

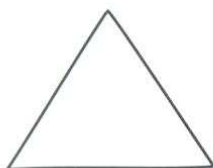

Saturday

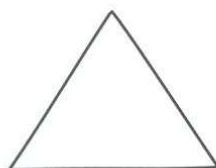

August



June

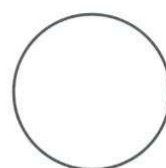

March

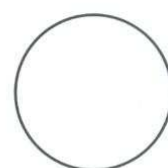

April



December



Thursday



Monday

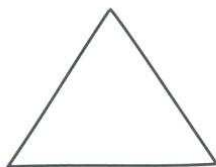

Tuesday



Friday



July

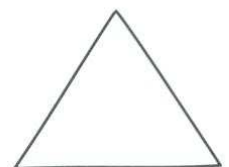

Sunday

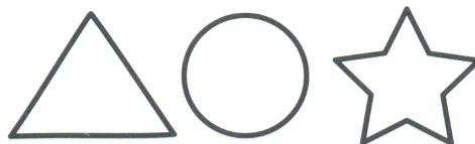

**FINISH**

# Board Game 13

## Topic 24

### How to play

Students play in pairs. Each student makes a toy cube. They roll their cubes at the same time. Both students call out the name of the toy at the top of their cube. If the items at the top are the same, the first student to call out, *Snap!* is the winner. Play until all toys have been called.

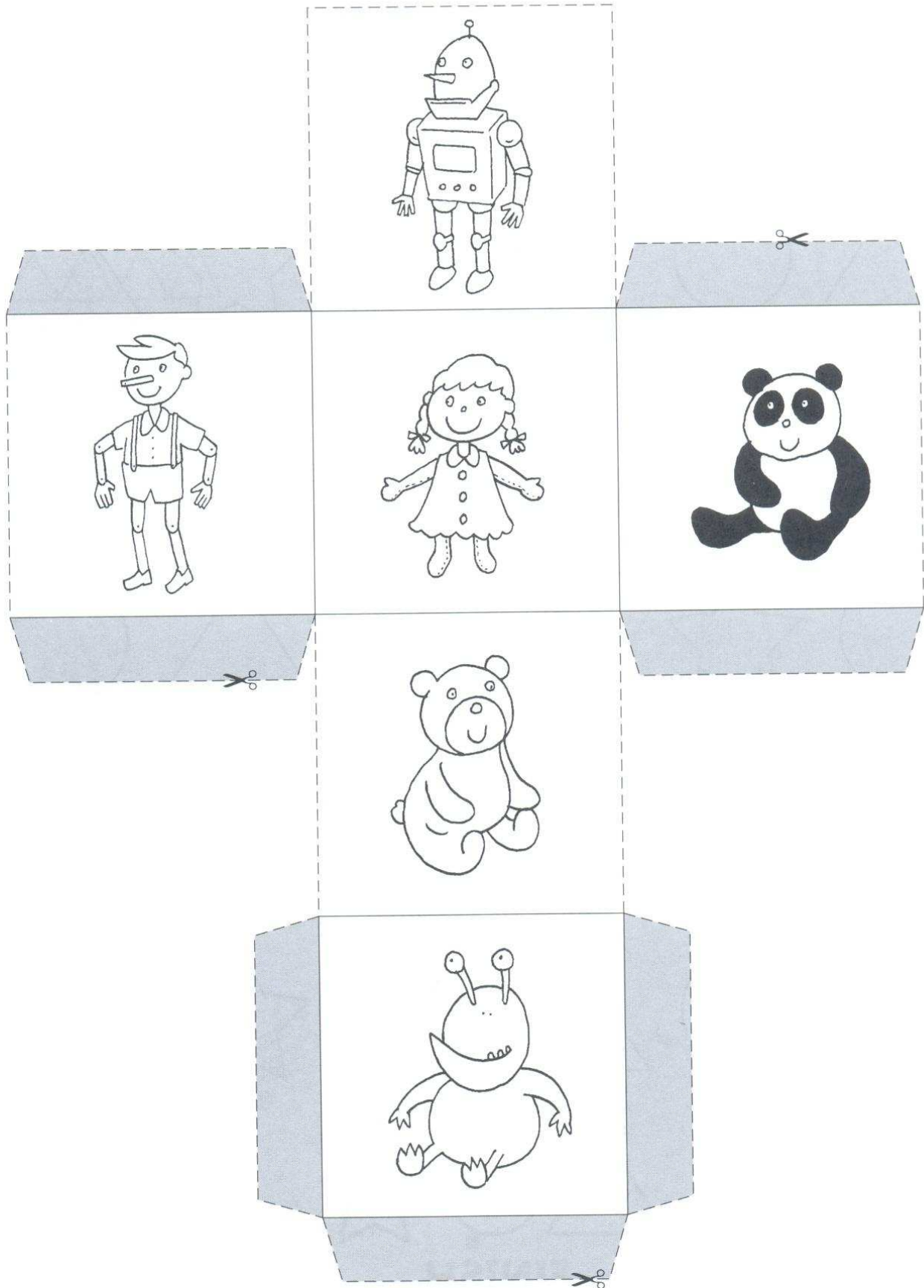

# Board Game 14

Topics 25, 26, 27

## How to play

Two to four players place their counters on the start. They take turns to roll the die and move the corresponding number of spaces on the board. When a student lands on a square, he/she must name the item or items, or follow the instructions. The winner is the first student to make it to the finish.

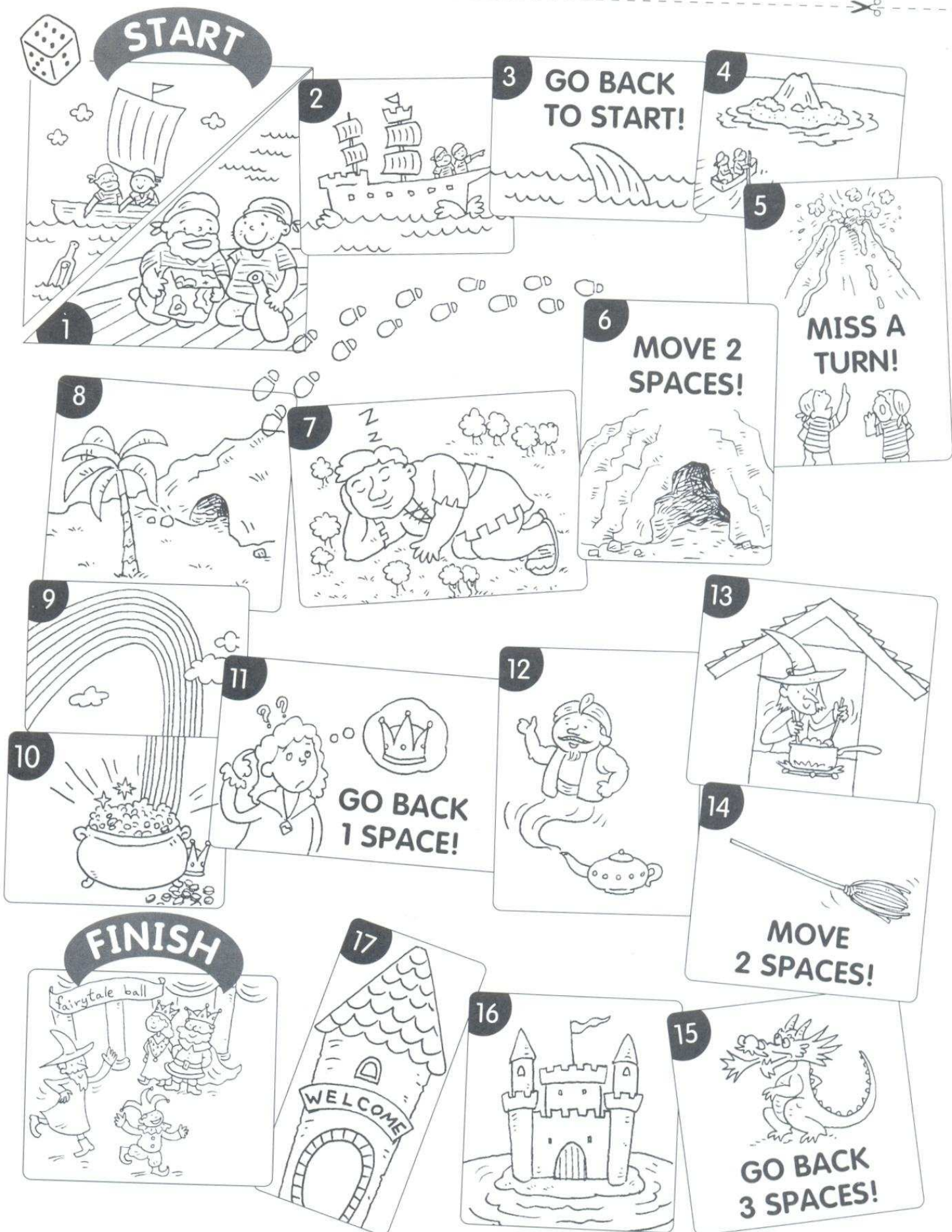











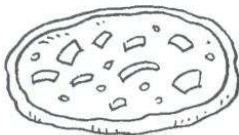

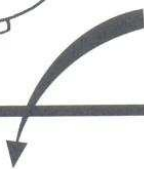
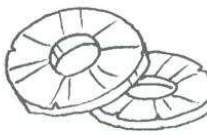
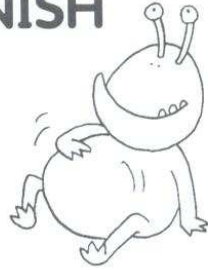

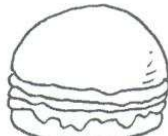

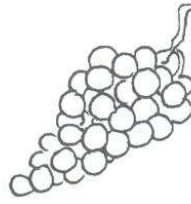

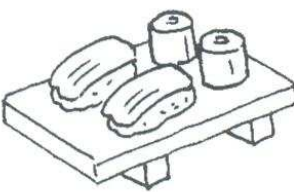
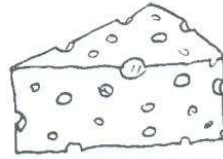

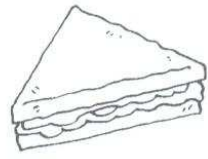
# Board Game 15

## Topics 28, 29, 30

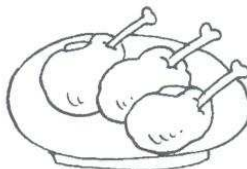
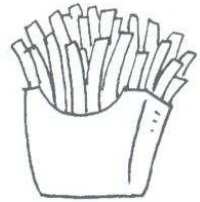
### How to play

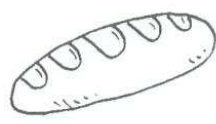
Two to four players place their counters on the starting square. They take turns to flip a coin and move the corresponding number of spaces on the board. They can move one space for heads and two spaces for tails. When a student lands on a square, he/she must name the item. If a student lands on a square with an arrow, he/she will either jump forward or back several squares. The winner is the first student to make it to the finish.

16. 	17.  	18. 	<b>FINISH</b> 
15. 	14.  	13. 	12. 
8. 	9. 	10. 	11. 
7. 	6.  	5. 	4. 
<b>START</b> 	1. 	2. 	3. 

# Board Game 16

## Topic 31

### How to play

This is an information gap activity. S1 is given one scene, S2 the other. They must not show their scenes to each other. Students must find out where the five missing things in their scenes are located and draw them on the picture. S1 asks, *Is the lake in C1?* S2 replies, *Yes, it is.* / *No, it isn't.* The winner is the first student to complete the scene.



### Student 1

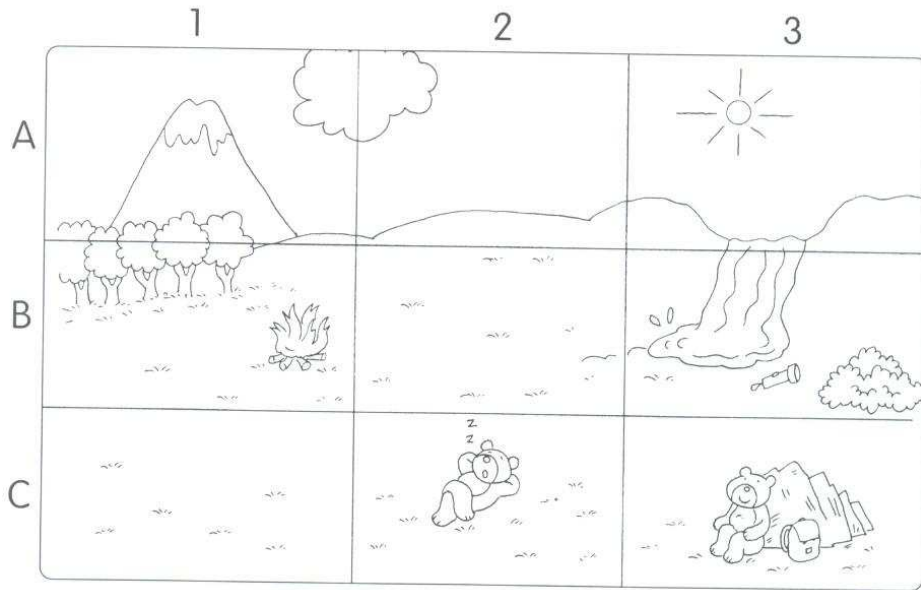

Find:	Notes
hill	
tent	
sleeping bag	

fishing pole	
lake	

E.g. *Is the hill in C3?*  
*Yes, it is.* / *No, it isn't.*



### Student 2

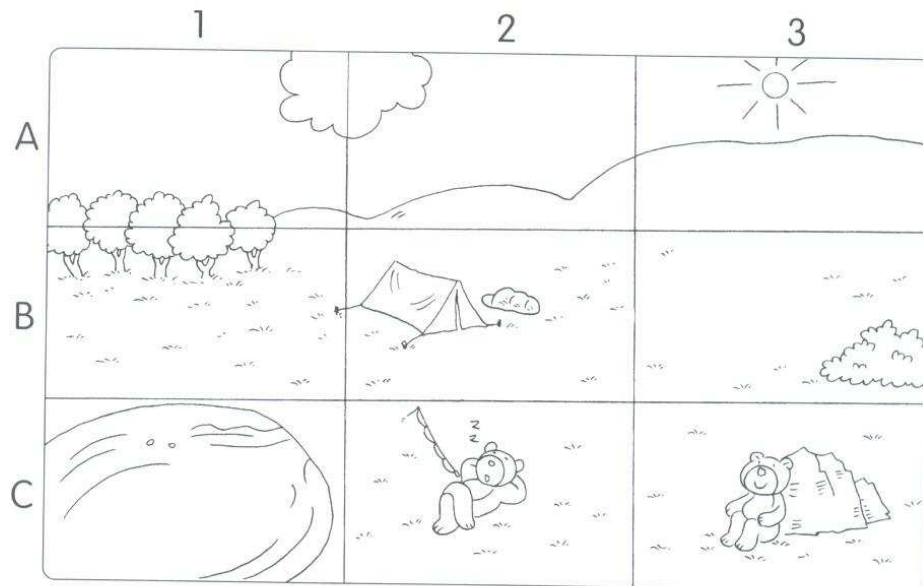

Find:	Notes
waterfall	
flashlight	
backpack	

campfire	
mountain	

E.g. *Is the waterfall in A1?*  
*Yes, it is.* / *No, it isn't.*

# Board Game 17

## Topic 32

### How to play

In pairs, students put a coin on the start and take turns to flick it onto the grids. Initially, S1 must land on a square in the activity grid, e.g. *skating*. S1 then says, *Let's go skating*. S2 tries to flick the coin on the *in-line skates* square in the item grid. If successful, he/she can reply with, *Sure. I'll get my in-line skates*. If unsuccessful, the students start again. The game is over when all the squares have been landed on.



### Item Grid

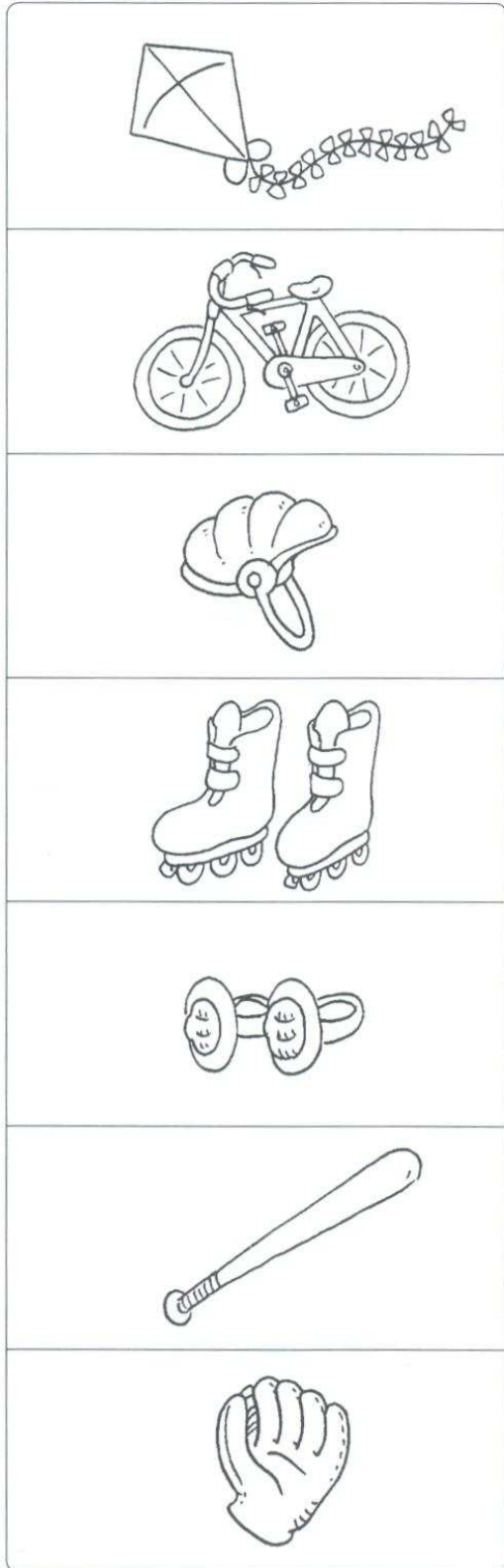

### Activity Grid

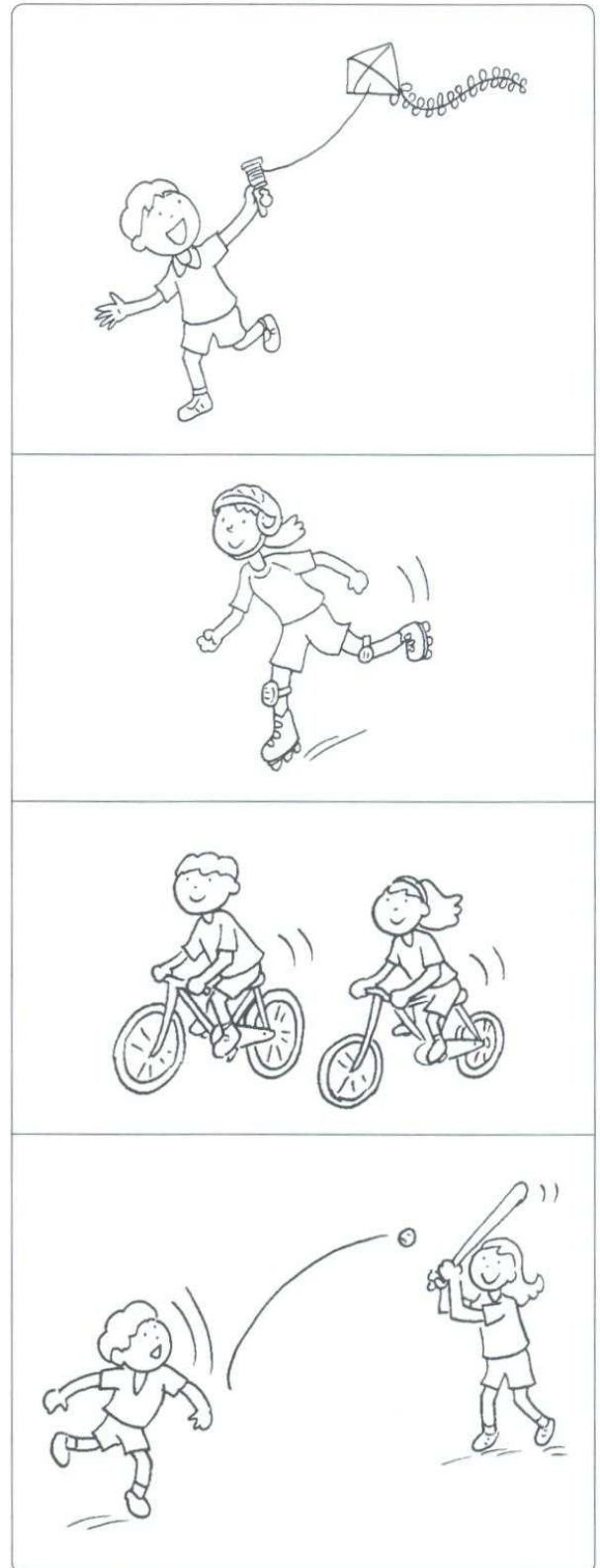

**START**

# Board Game 18

Topics 33, 34, 35

## How to play

Students play in two pairs. They cut out the number cards and look at the board for one minute to try and memorize the animals. One pair turns their backs, while the other pair places the number cards over four of the animals on the board. The first pair looks at the board and tries to call out the names of the animals hidden under the number cards 1-4 in the correct order. When they finish, the pairs switch roles and play again.



# Board Game 19

Topics 36, 37

## How to play

In groups of three, students take turns to be the joey and the kangaroo parents. The aim of the game is for the joey to get home before his parents find him. Each takes turns to move one space horizontally or vertically but not diagonally. When students land on a circle, they name the item. The joey can use the safe zones, but the kangaroos cannot move onto these circles. The joey is found if a kangaroo moves onto the same circle as the joey. This means the kangaroos win. However, if the joey makes it home, then he is the winner.

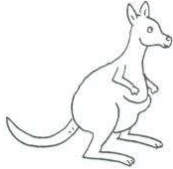

**HOME**

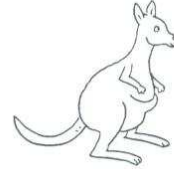

<b>START</b>		<b>SAFE ZONE</b>		<b>SAFE ZONE</b>	<b>START</b>
<b>SAFE ZONE</b>		<b>SAFE ZONE</b>		<b>SAFE ZONE</b>	
		<b>START</b>	<b>SAFE ZONE</b>		

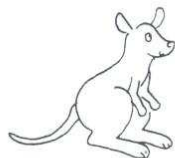

# Board Game 20

Topics 38, 39, 40

## How to play

In pairs, students cut out the letters, scramble them face up and pick six letters. They take turns to try and make a word. If they can't, they can replace one letter with another one to use next time. The winner is the first student to get rid of all his/her letters.

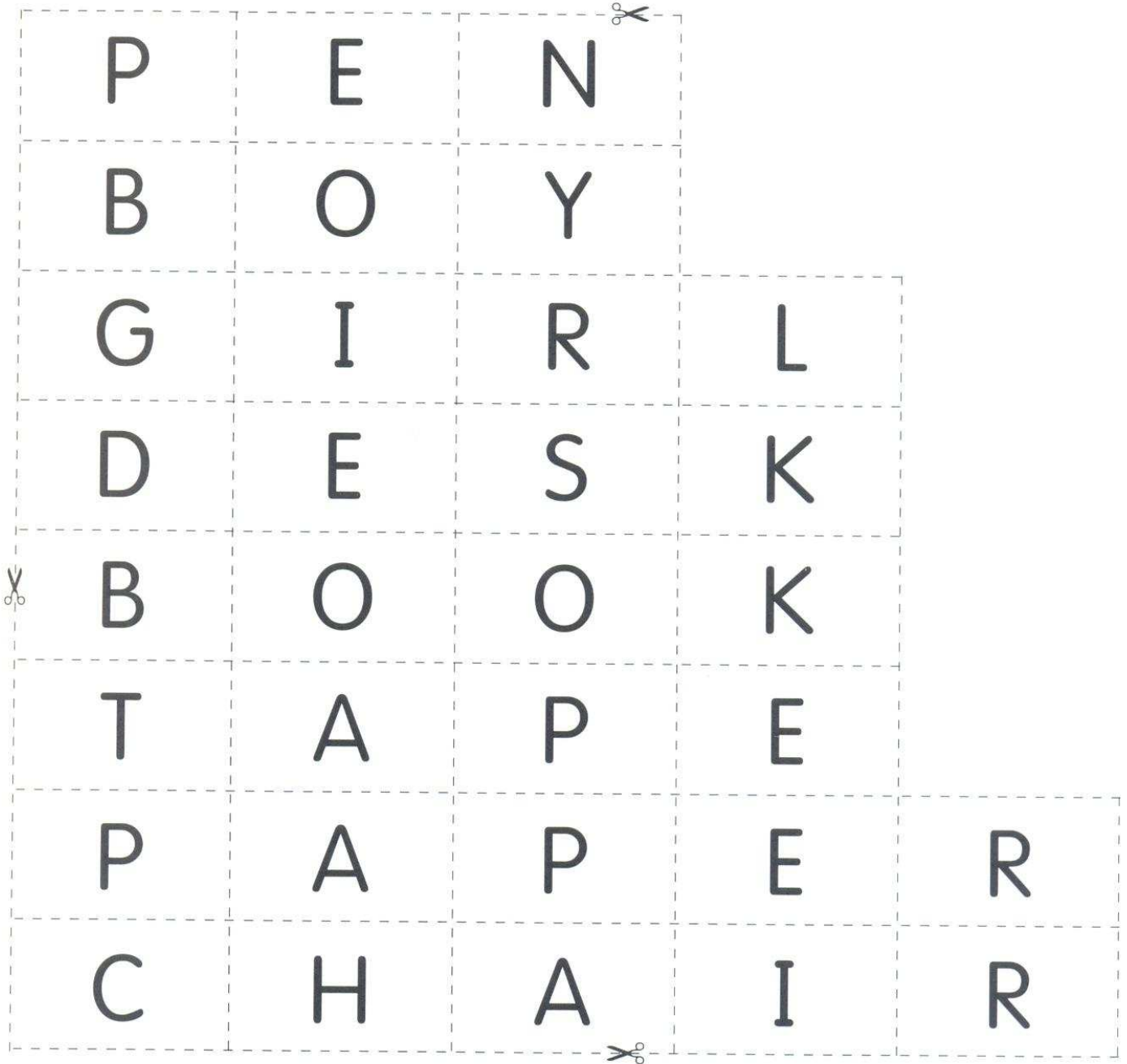

# Board Game 21

## Topic 41

### How to play

In groups of two to four, students cut out the dominoes, turn them face down and mix them up. Each student takes five dominoes. They take turns to place their dominoes down on the table, naming and matching items in a long chain. If they can't place a domino down, they must pick one up from the pile. The winner is the first student to get rid of all his/her dominoes.

Scissors icon at the top left and top right of the grid.

						1 <sup>st</sup>
	1 <sup>st</sup>	2 <sup>nd</sup>	3 <sup>rd</sup>			
1 <sup>st</sup>	2 <sup>nd</sup>	3 <sup>rd</sup>				
1 <sup>st</sup>	2 <sup>nd</sup>	2 <sup>nd</sup>	3 <sup>rd</sup>			
1 <sup>st</sup>	2 <sup>nd</sup>	3 <sup>rd</sup>				1 <sup>st</sup>
2 <sup>nd</sup>	3 <sup>rd</sup>					

# Board Game 22

## Topic 42

### How to play

Glue the spinner to cardboard, cut it out and stick a used matchstick through the center. Students play in pairs. S1 spins the spinner in the middle of the big circle. He/she tries to name the instrument closest to where the spinner has landed. He/she then matches the number to the word in the chart below. Then students change roles. The game is over when all the instruments have been named.

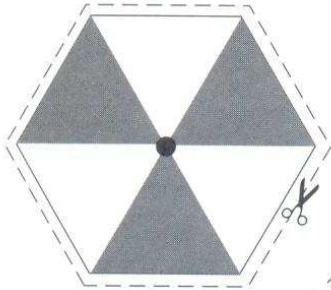

spinner

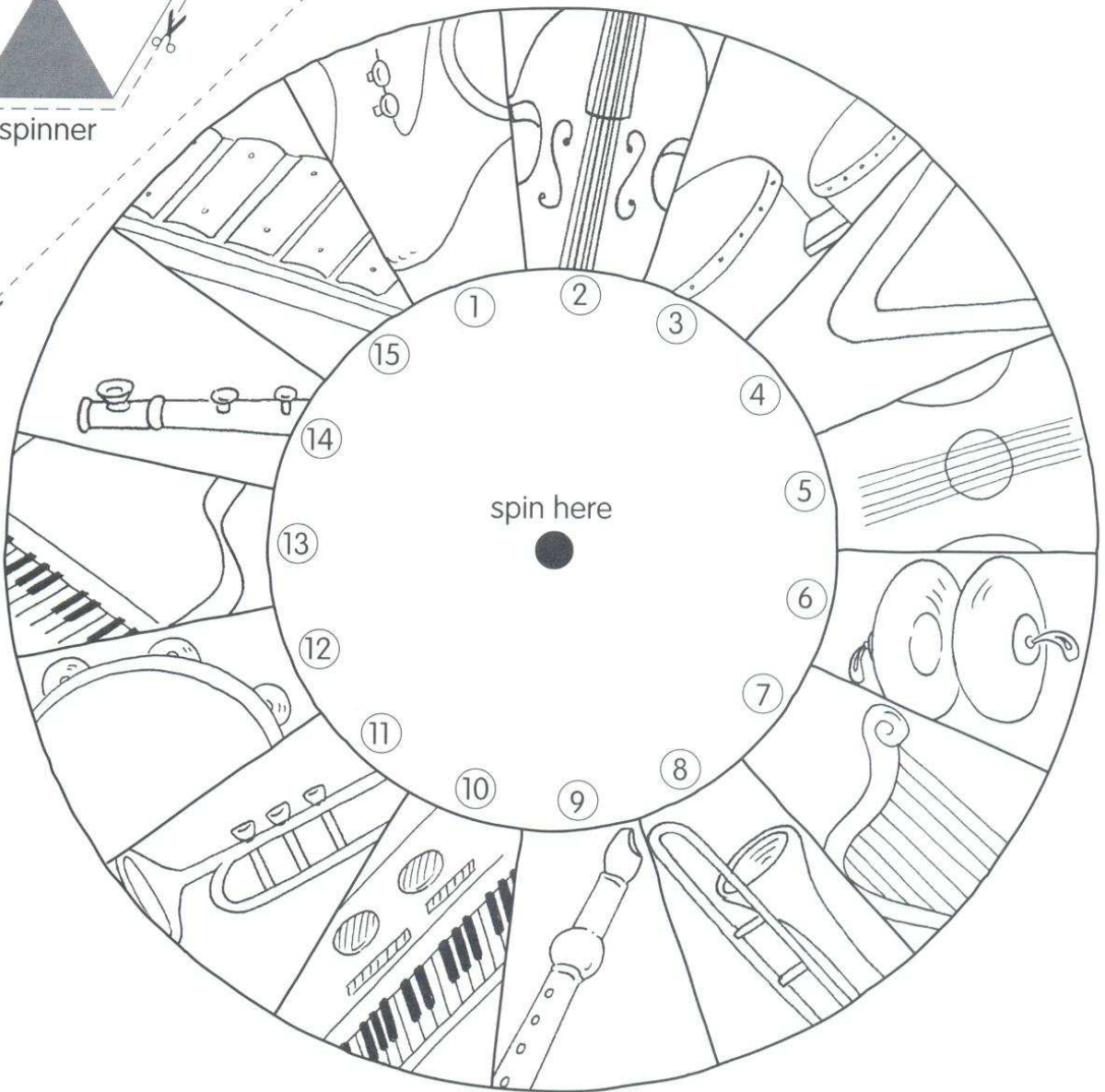

13	piano	keyboard	cymbals
	saxophone	guitar	recorder
	harp	trombone	violin
	trumpet	xylophone	triangle
	bongo drums	flute	tambourine



# Board Game 23

Topics 43, 44

## How to play

Students cut out the animal cards and place sixteen of them on their bingo boards. They play in groups or as a class. The teacher or a student calls out the items randomly. Students remove the cards from their boards as they are called out. Unlike regular bingo, the aim of the game is to keep as many cards as possible on the board. The winner is the student with the most cards remaining, once all have been called out.

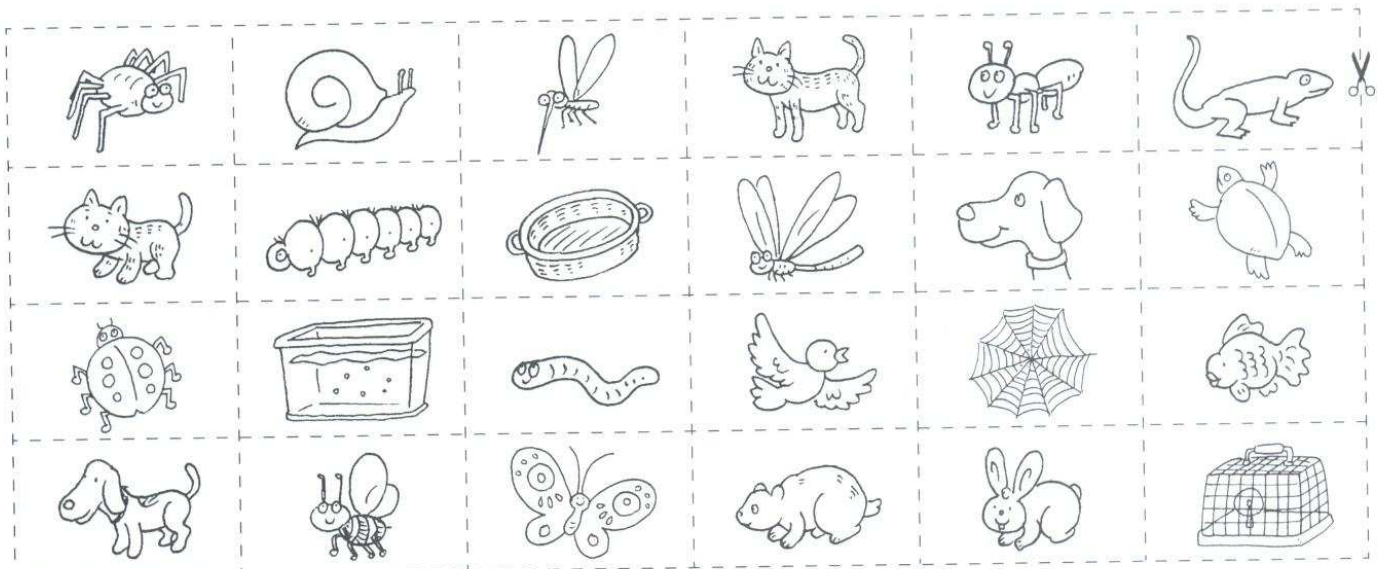
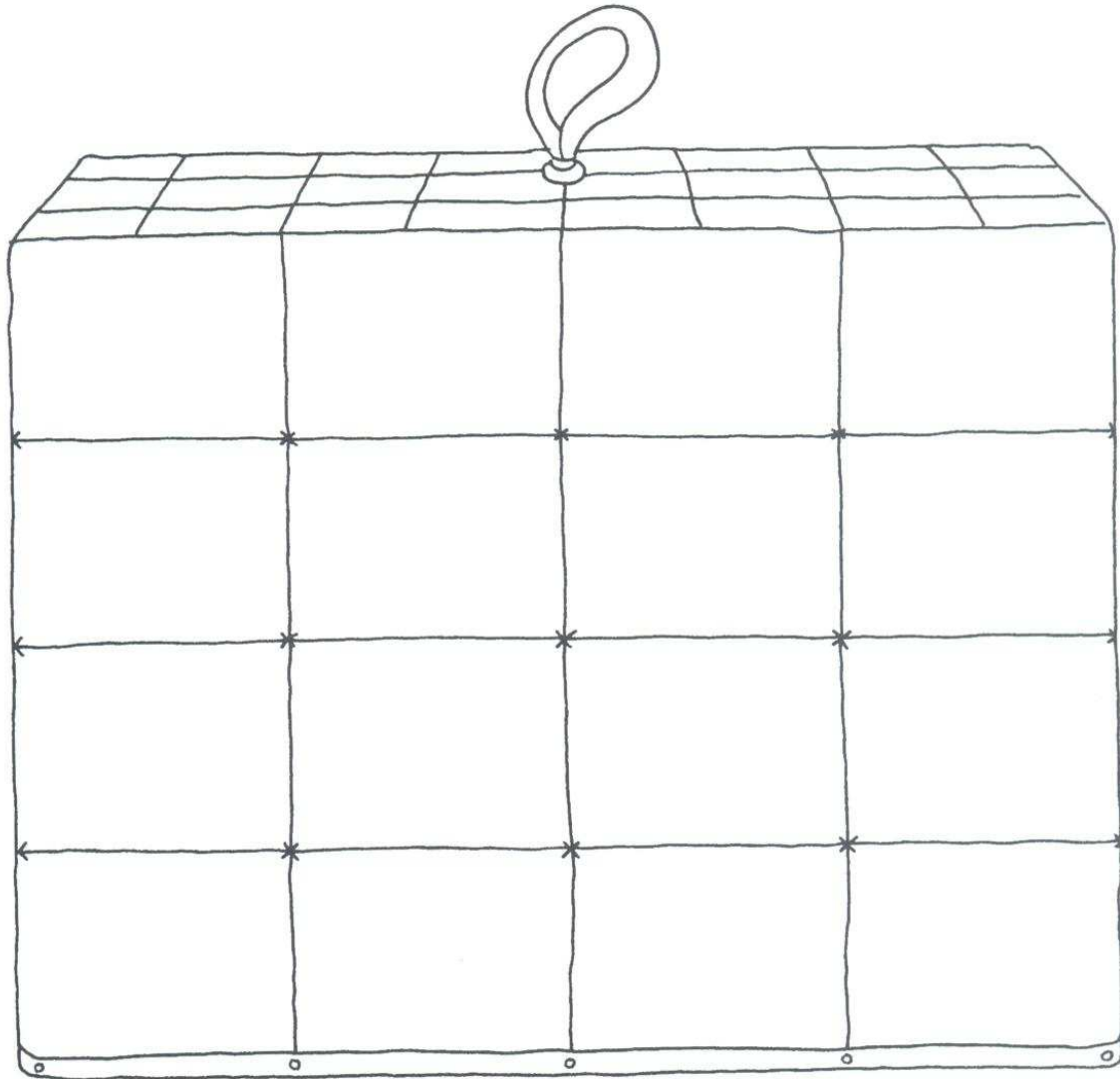

# Board Game 24















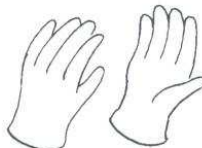

Topics 45, 46

## How to play

In groups of two to four, students choose three clothing items each and write them on their clothes lists. They place their counters on the start and take turns to roll the die and move around the board. When a student lands on a square, he/she must name the item. If a student lands on an item on his/her clothes list, he/she can write a check next to it. The winner is the first student to collect all three items on his/her list.



**START**

 T-shirt	 cap	 skirt	 jeans
 belt	 blouse	 gloves	 boots
 dress	 shirt	 pants	 apron
 watch	 raincoat	 shoes	 glasses

**Student 1**

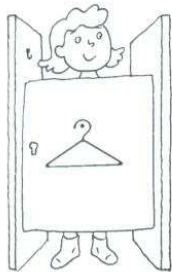

**Student 2**

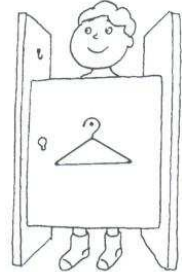

**Student 3**

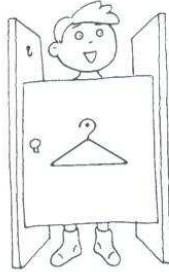

**Student 4**

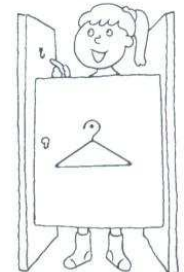

Clothes list

- 1.
- 2.
- 3.

Clothes list

- 1.
- 2.
- 3.

Clothes list

- 1.
- 2.
- 3.

Clothes list

- 1.
- 2.
- 3.

# Board Game 25

Topics 47, 48

## How to play

In pairs, students cut out the Word Cards and place them face down in a pile. Each student has a Game Card and a small mirror. They take turns to pick a card and try to find the matching word on their Game Card. They can use the mirror to help them. If they find a match, they name it and place the card on that square. If they don't find a match, the card goes to the bottom of the pile. The winner is the first student to complete his/her Game Card.



## Word Cards



neck	ear	hand	knee
face	nose	leg	paw
arm	fur	tail	head

## Student 1 Game Card

## Student 2 Game Card

nose	ear
arm	neck
hand	paw



fur	tail
face	knee
head	leg













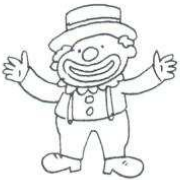







# Board Game 26

## Topic 49

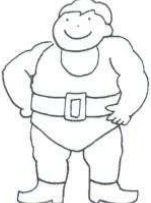
### How to play

This is a guessing game played in pairs. Each student secretly picks one character from the scene and writes it on a scrap of paper. S1 can ask up to ten questions to guess S2's character, e.g. S1, *Is it a clown?* S2, *No, it isn't.* S1, *Is it a juggler?* S2, *Yes, it is.* S1, *Is he tall?* S2, *No, he isn't.* S1, *Is he wet?* S2, *Yes, he is.* S1, *It's A3, a wet juggler!* For every question that S1 asks, S2 gets a point. Students change roles and play again until both have had three turns. The winner is the student with the most points.

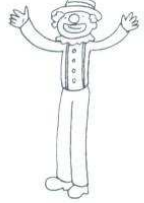

	1	2	3	4
A				
B				
C				
D				
E				

### Student 1

*Is it a clown ?*  
*Is he/she tall ?*  
*Is it a juggler ?*  
*Is he/she wet ?*  
*It's A3 !*

### Student 2

*No, it isn't.*  
*No, he/she isn't.*  
*Yes, it is.*  
*Yes, he/she is.*  
*A wet juggler!*

Student 1	Student 2

# Board Game 27

## Topic 50

### How to play

Two to four players place their counters on the start. They take turns to flip a coin and move the corresponding number of spaces on the board. They can move one space for heads and two spaces for tails. When a student lands on a square, he/she must name the item or answer the question. The winner is the first student to make it to the finish.

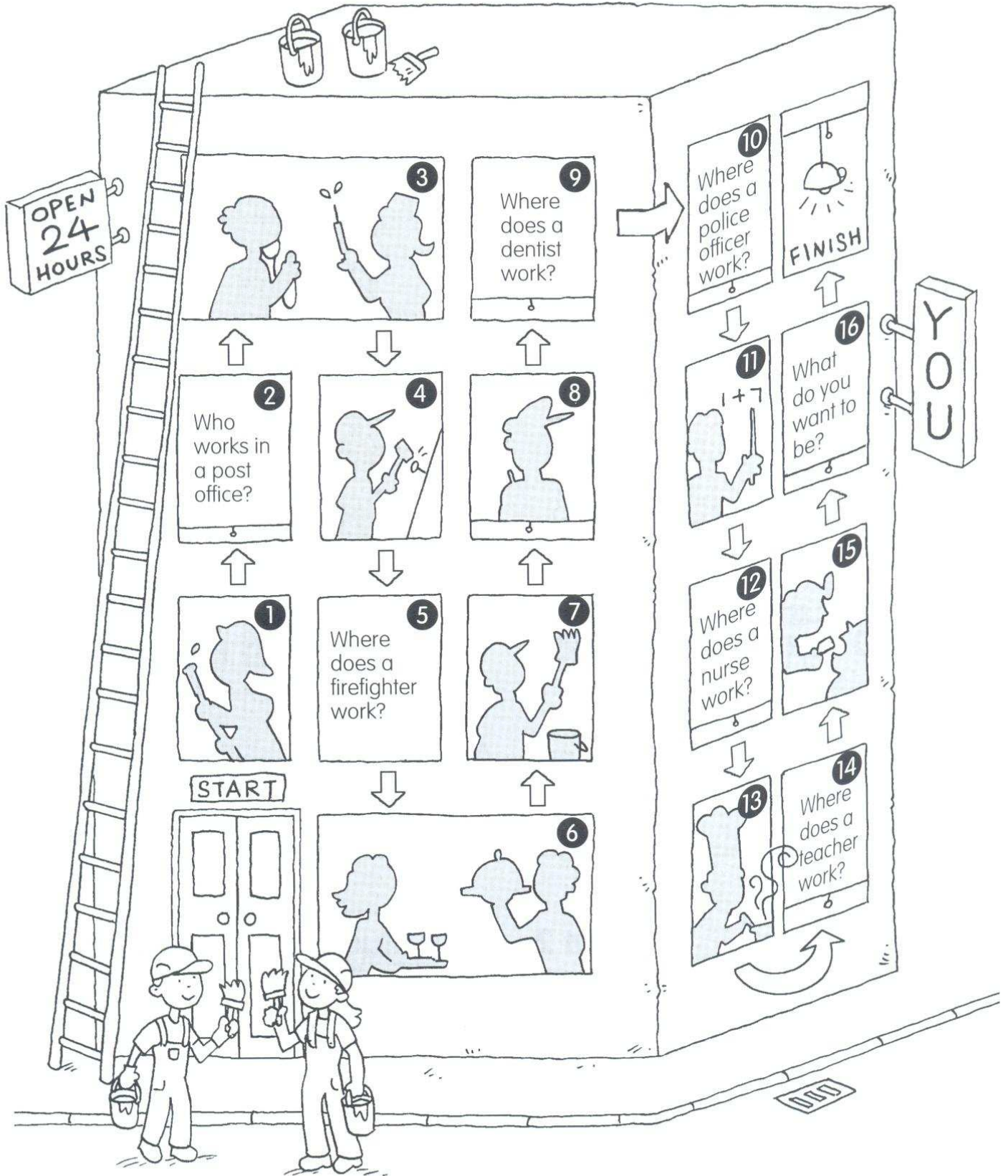

b

1

d

1

B

1

D

1

a

1

c

1

A

1

C

1

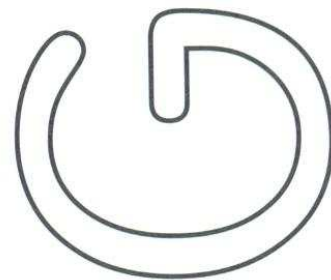
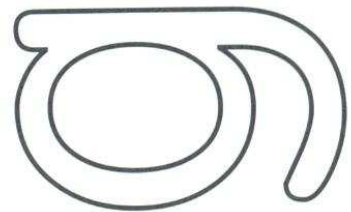
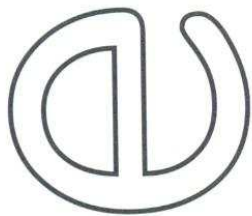
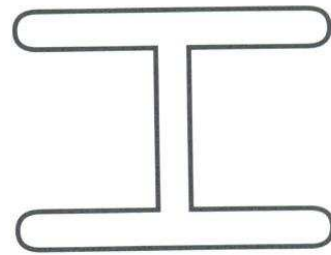
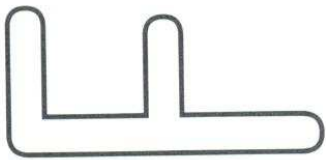
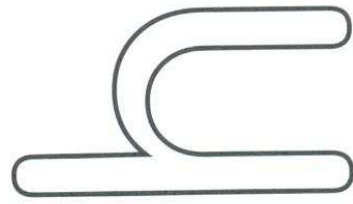
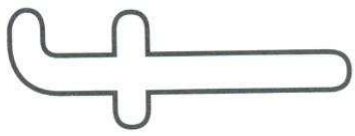

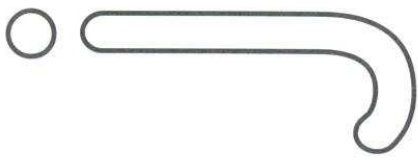

1



1

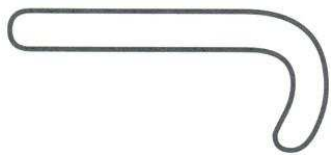

1



1



1

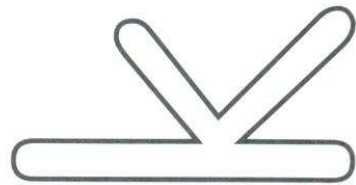

1



1

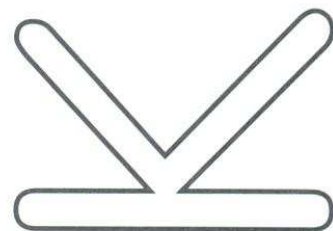





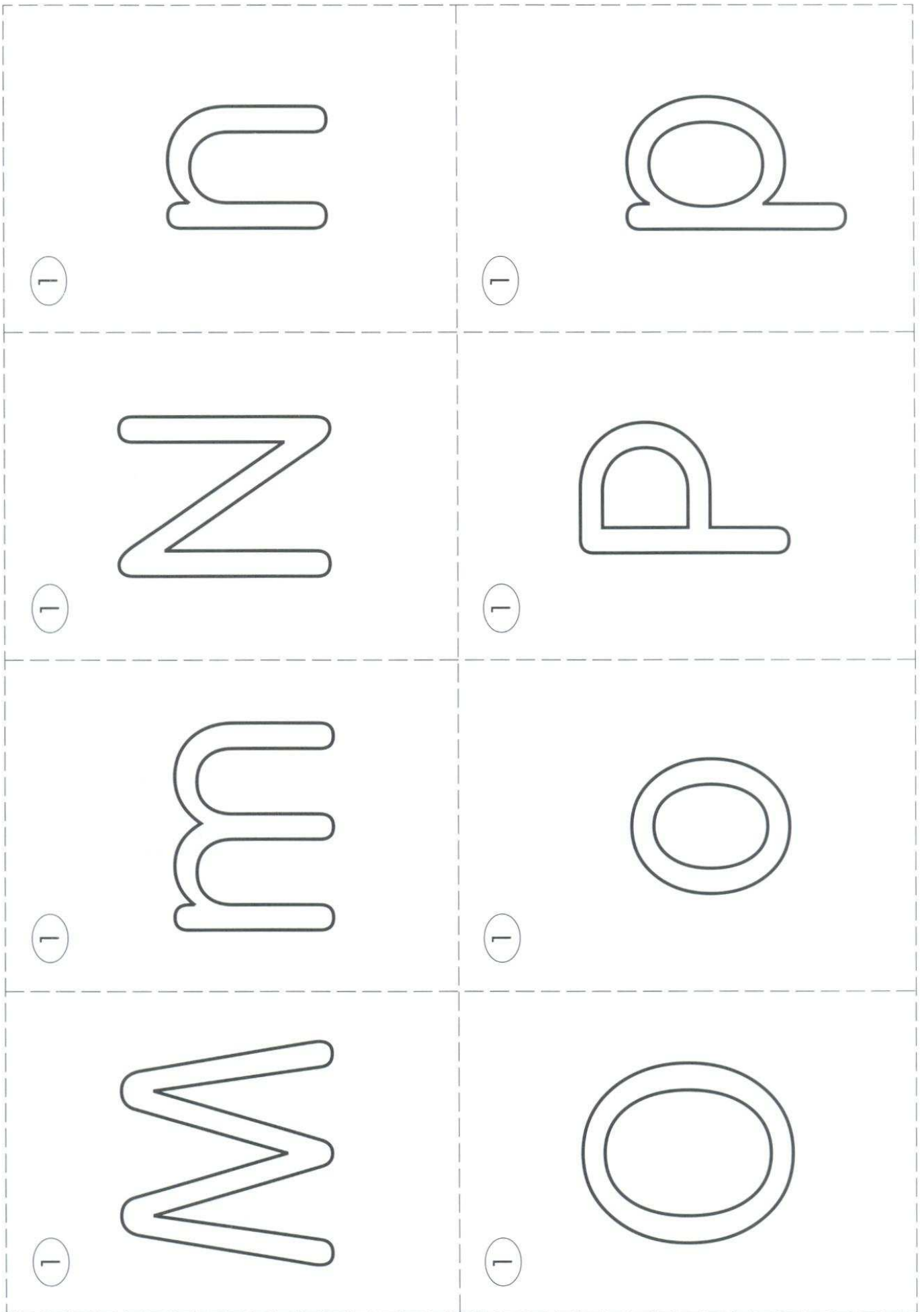

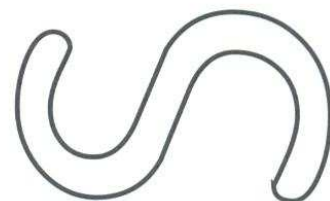
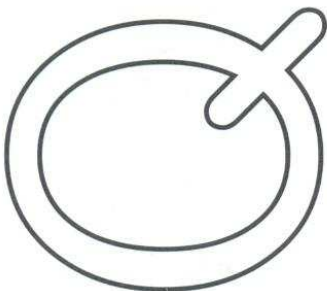
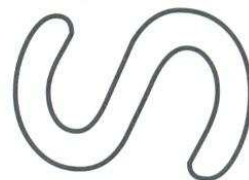
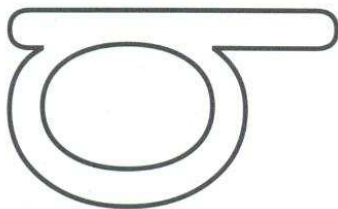
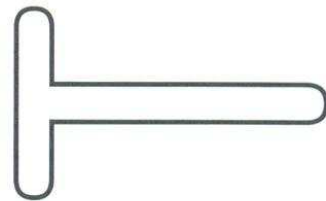
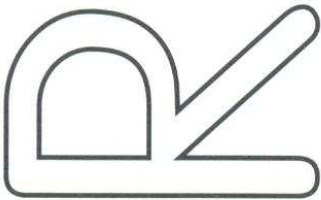
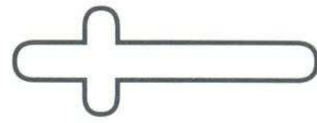

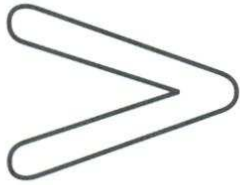

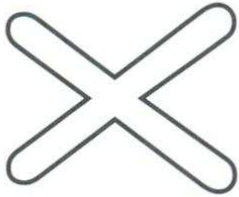

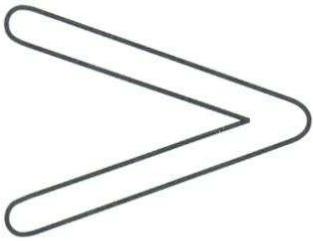

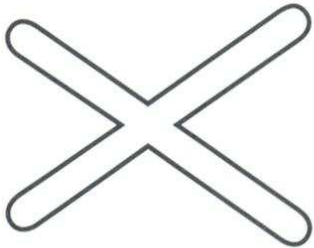
1

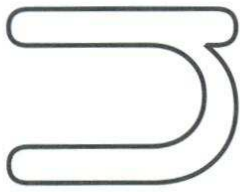

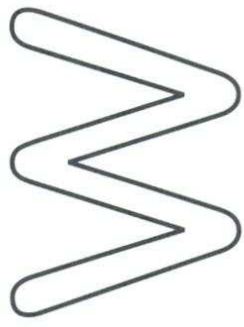

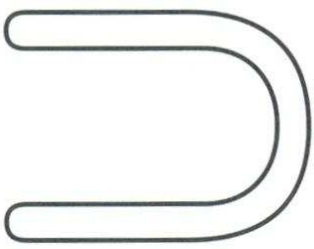

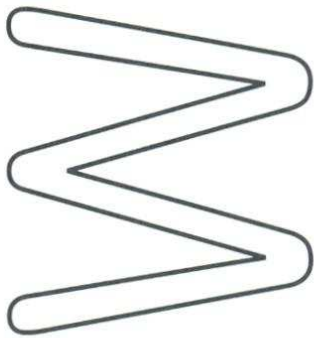
1

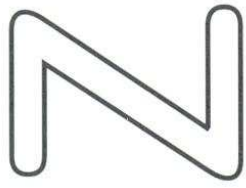

2

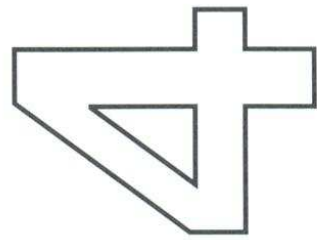

four

1

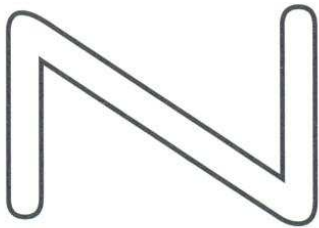

2



three

1

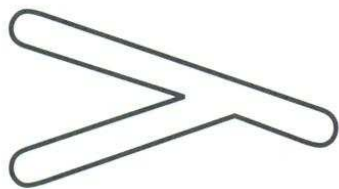

2



two

1

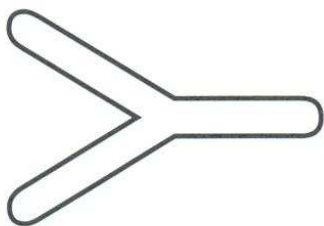

2

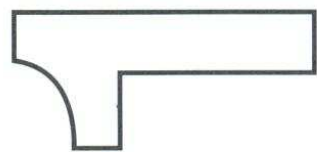

one

2

5

five

2

6

six

2

7

seven

2

8

eight

2

9

nine

2

10

ten

2

11

eleven

2

12

twelve

2

13

thirteen

2

14

fourteen

2

15

fifteen

2

16

sixteen

2

17

seventeen

2

18

eighteen

2

19

nineteen

2

20

twenty

3

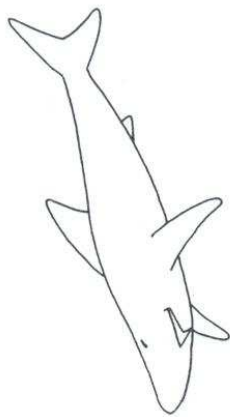

shark

3

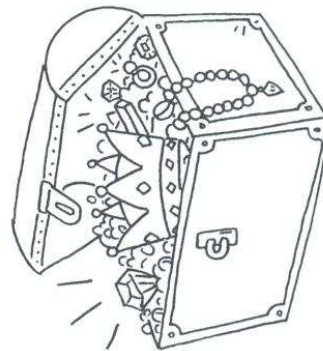

treasure chest

3

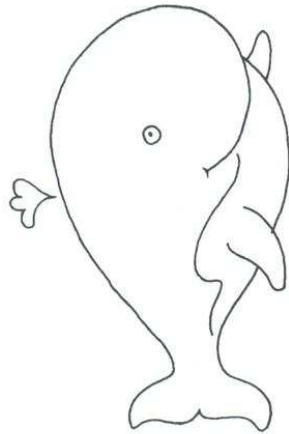

whale

3

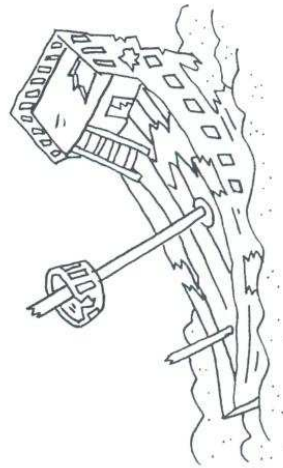

shipwreck

3

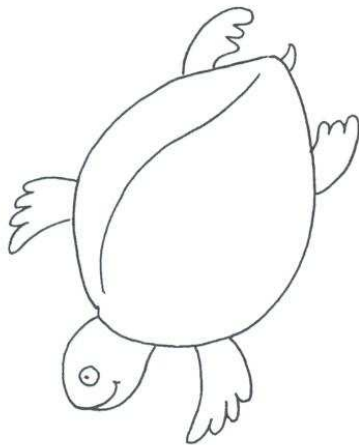

turtle

3



rock

3

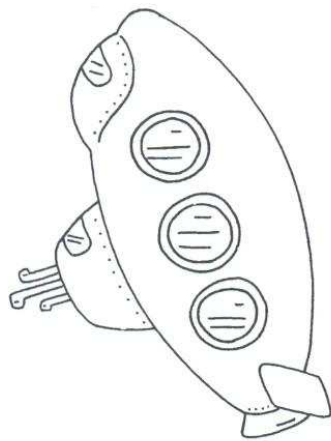

submarine

3

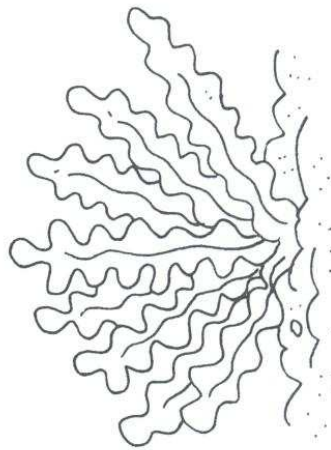

seaweed

3



yellow

3

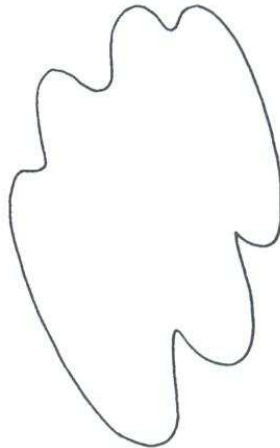

white

3

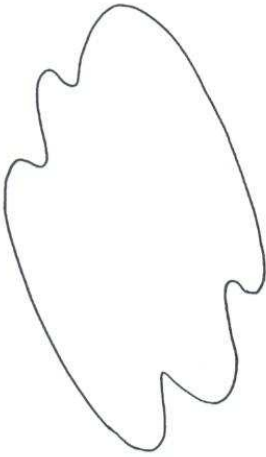

green

3

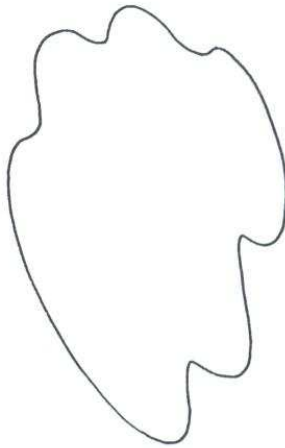

silver

3

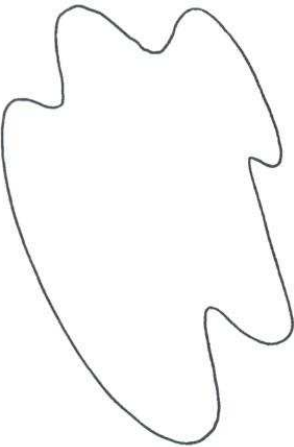

brown

3

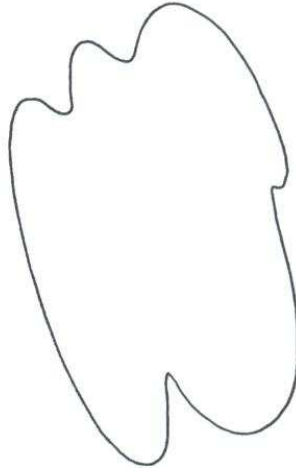

gold

3

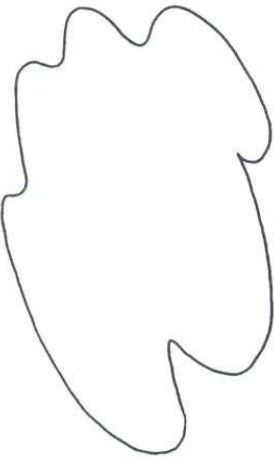

black

3



gray



3



mermaid

4

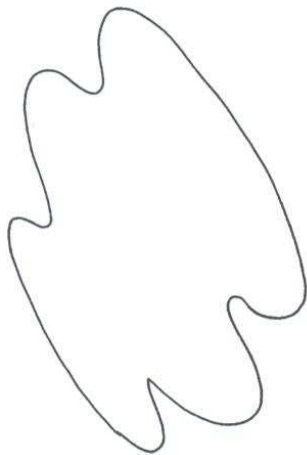

blue

4

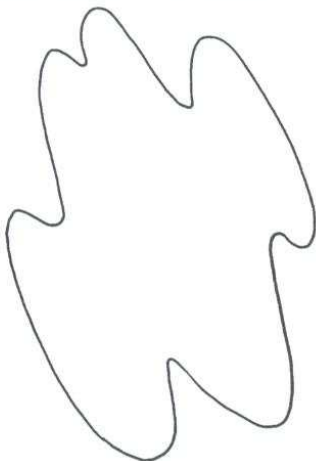

red

4

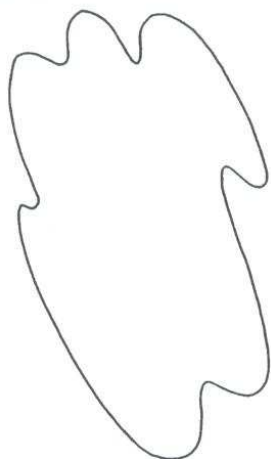

purple

4

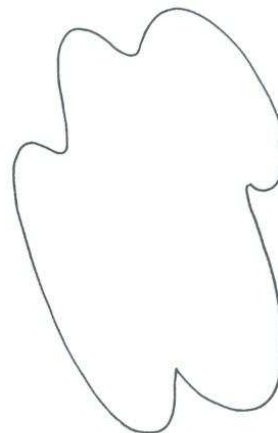

pink

4

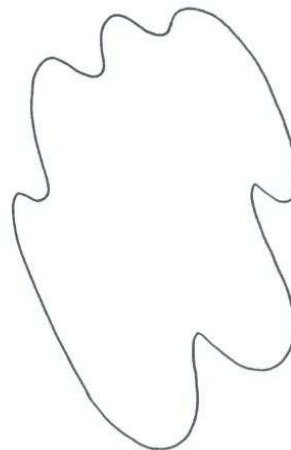

orange

4

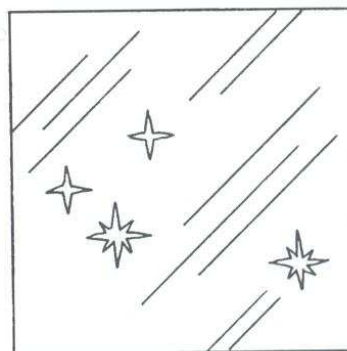

shiny

4

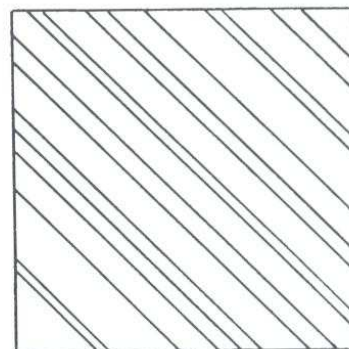

striped

4

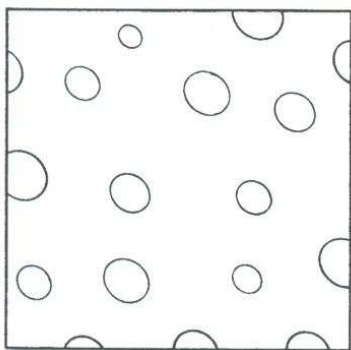

spotted

4



fish

4

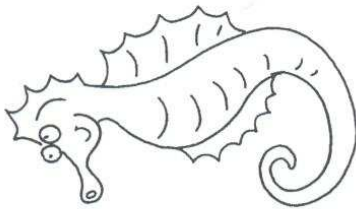

seahorse

4

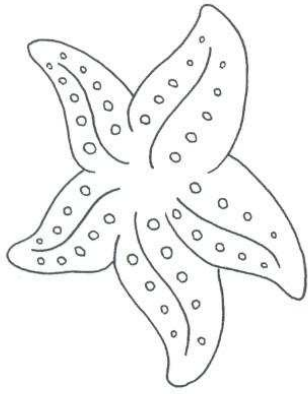

starfish

4

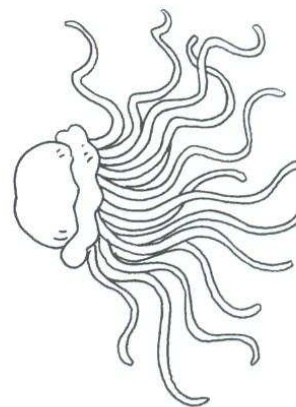

jellyfish

4

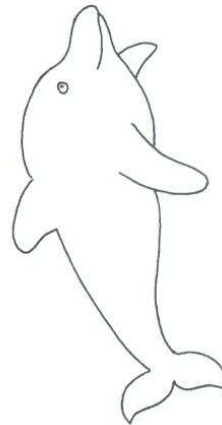

dolphin

4

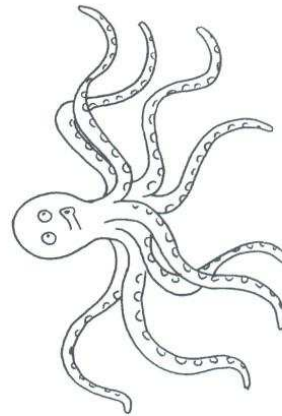

octopus

4

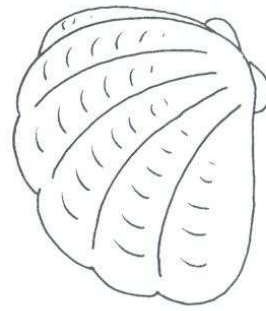

shell

4

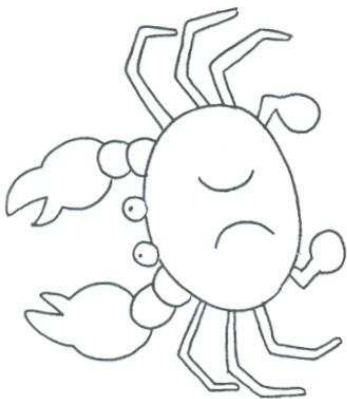

crab

4



treasure

4



Neptune

5

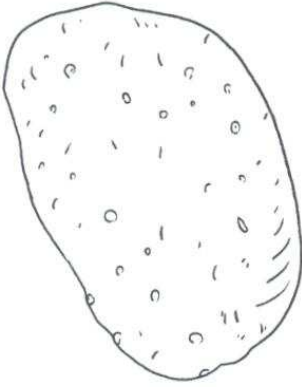

potato

5

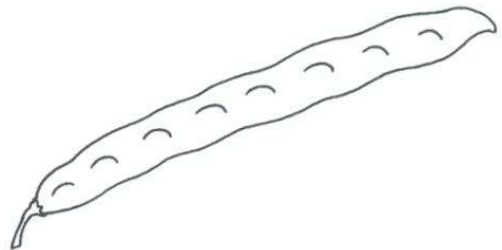

bean

5



onion

5

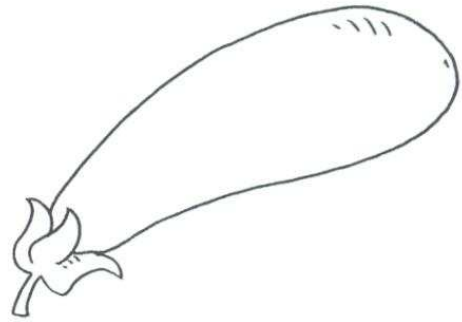

eggplant

5



lettuce

5

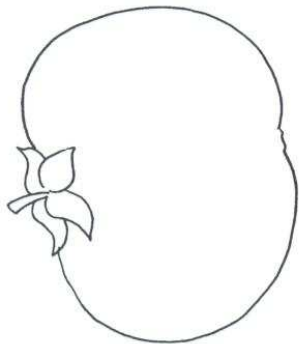

tomato

5

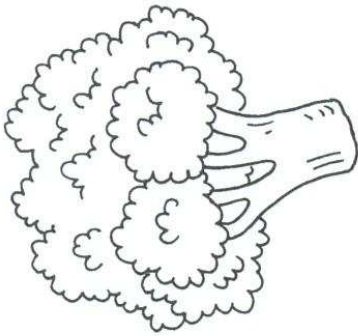

broccoli

5

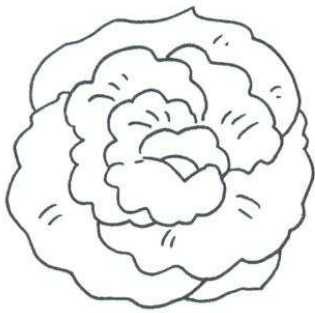

cabbage

5

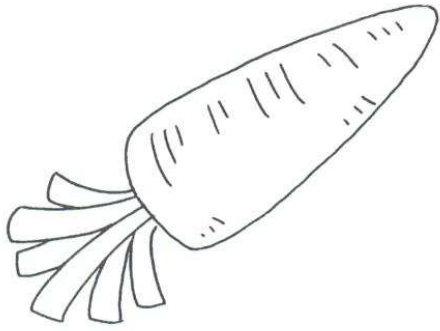

carrot

5

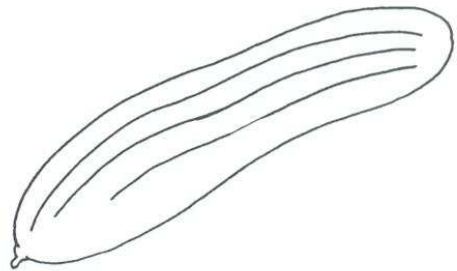

cucumber

5

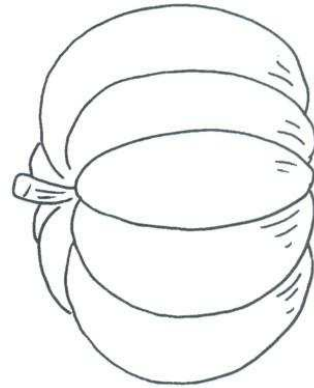

pumpkin

5

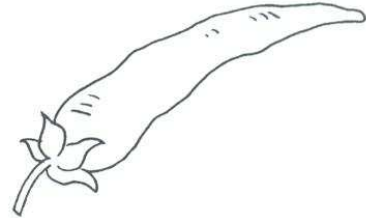

chili

5

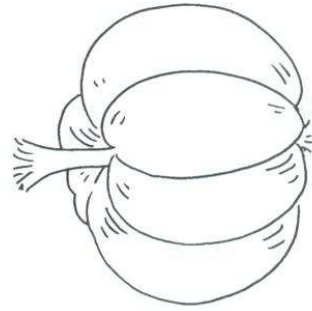

garlic

5

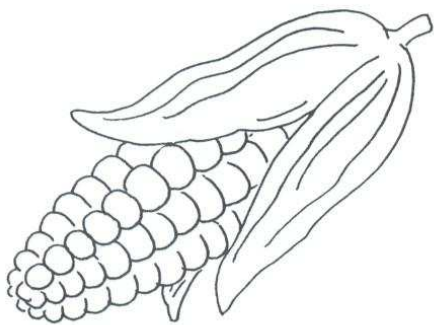

corn

5

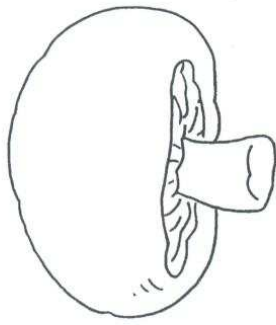

mushroom

5

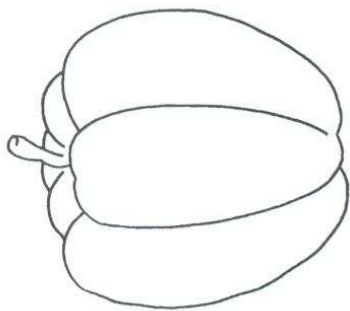

green pepper

5



singing

5



dancing

5



playing music

6

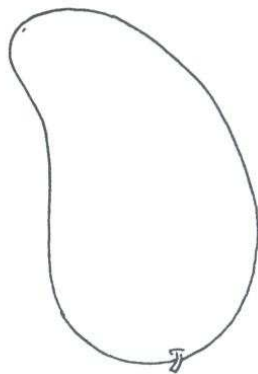

mango

6

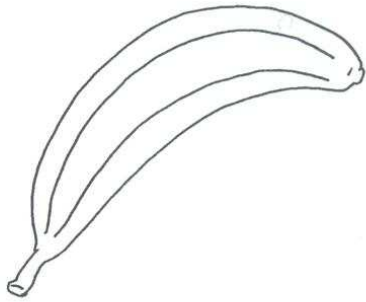

banana

6

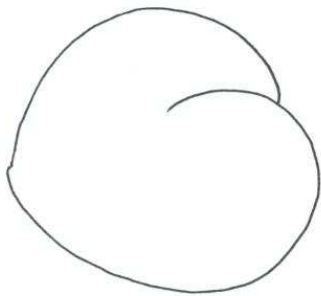

peach

6

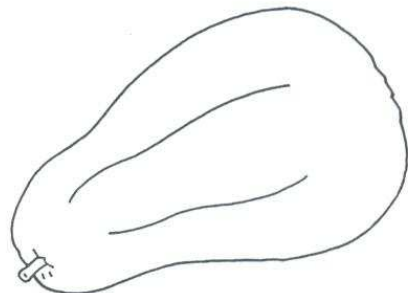

papaya

6

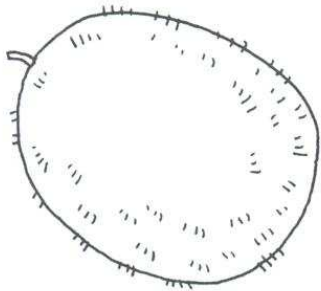

kiwi

6

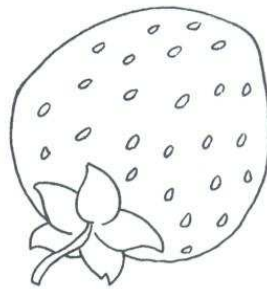

strawberry

6

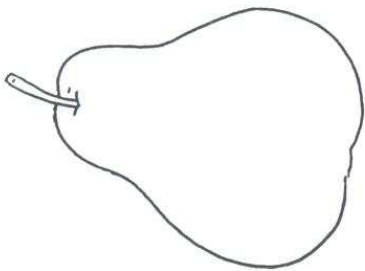

pear

6

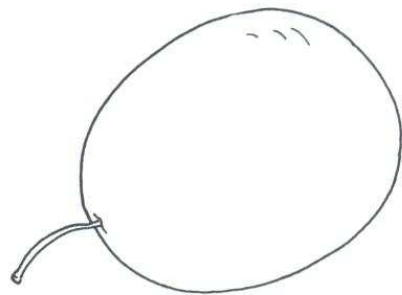

plum

6

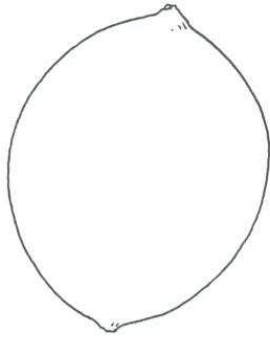

lemon

6

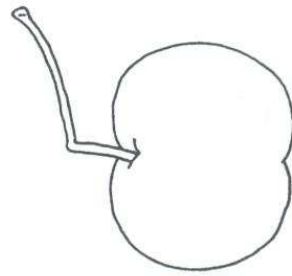

cherry

6

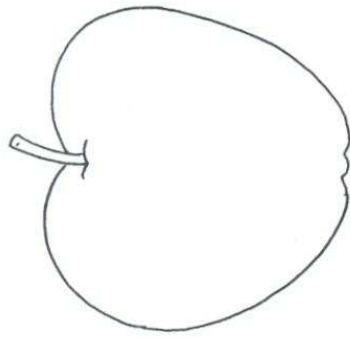

apple

6

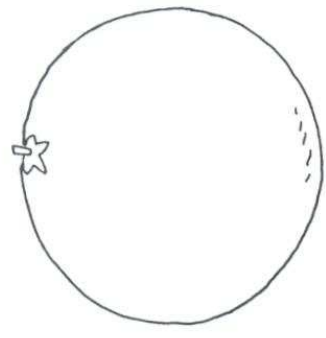

orange

6

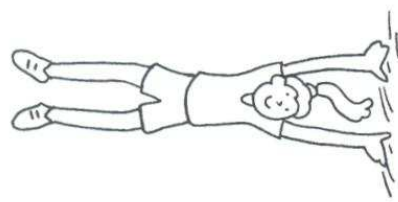

do a handstand

6

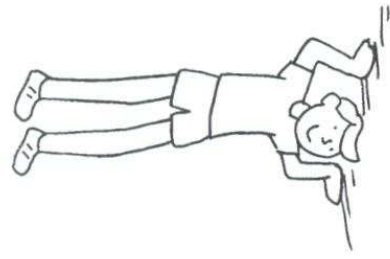

do a headstand

6



do a somersault

6



do a cartwheel

7

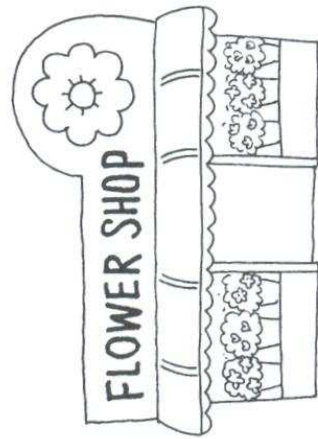

flower shop

7



bakery

7

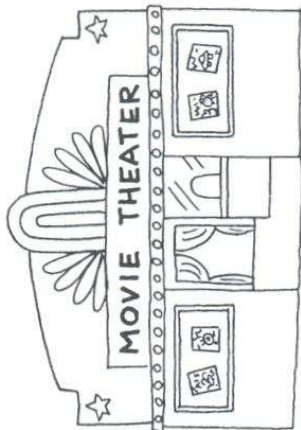

movie theater

7

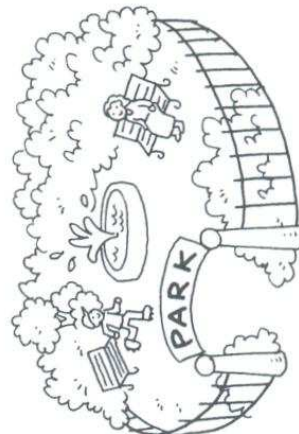

park

7

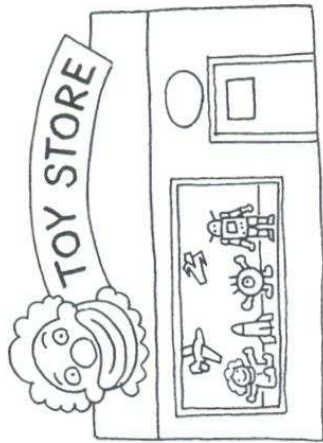

toy store

7



supermarket

7

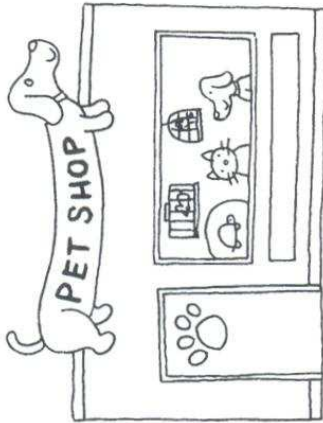

pet shop

7



bookstore

7

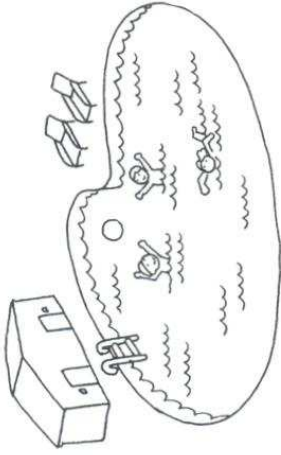

swimming pool

7

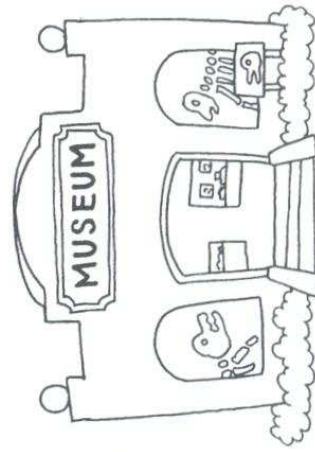

museum



7

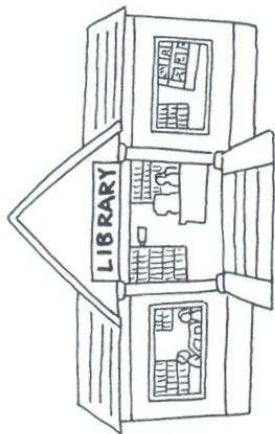

library

7

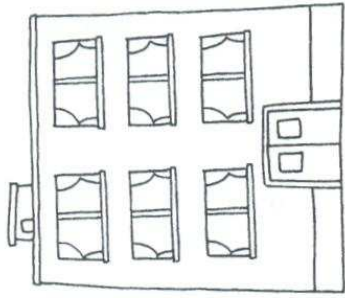

apartment building

7



mailbox

7

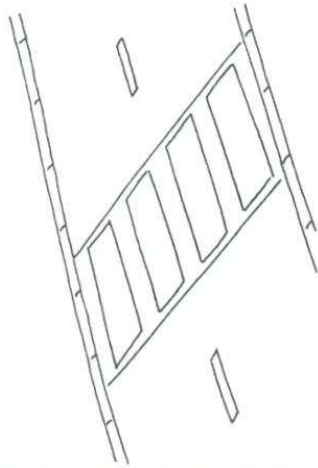

crosswalk

7

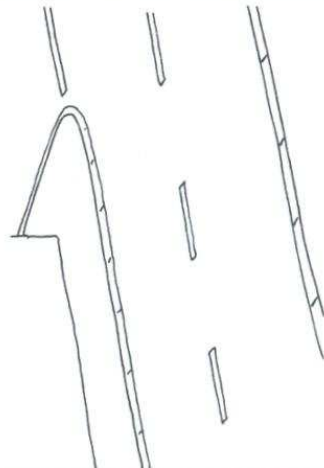

street

8

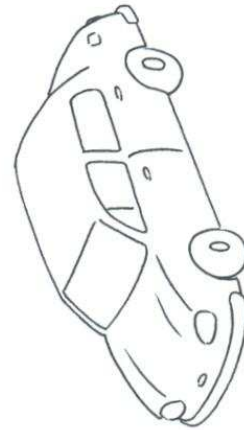

car

8

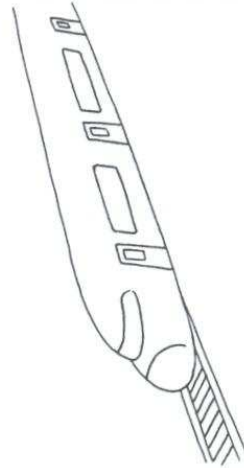

train

8

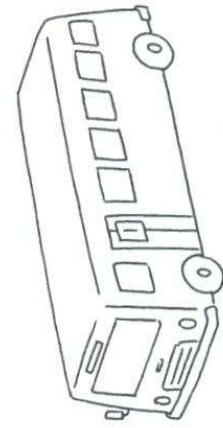

bus

8

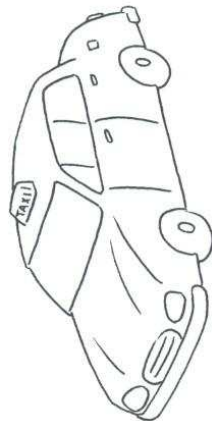

taxi

8



truck

8

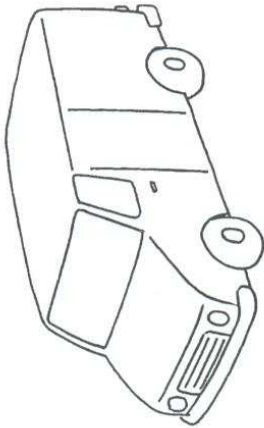

van

8

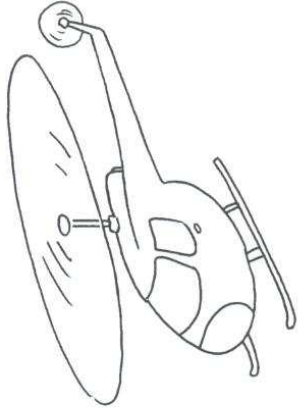

helicopter

8

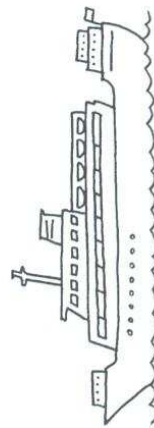

ship

8

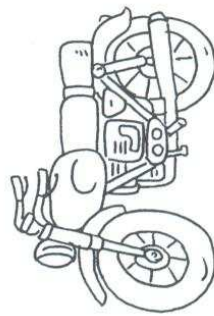

motorcycle

8

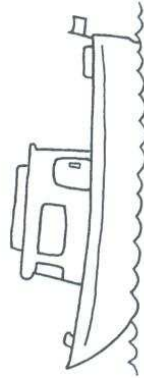

boat

8

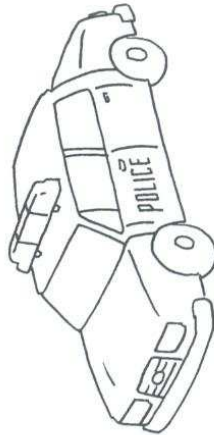

police car

8

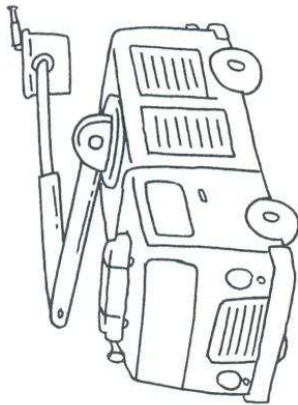

fire truck

8

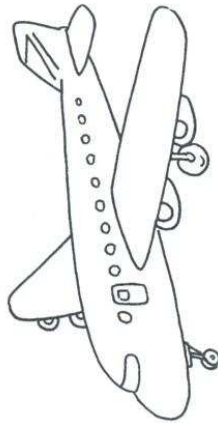

airplane

8

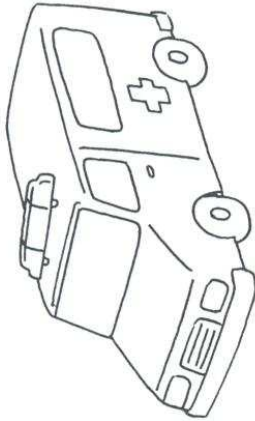

ambulance

8



bus stop

8

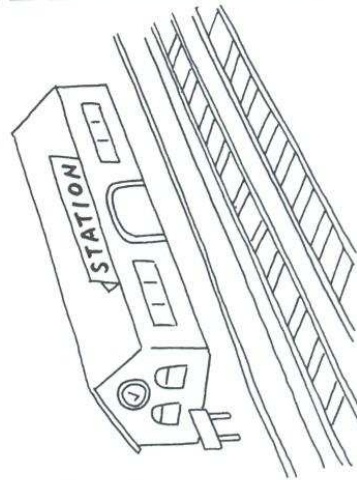

train station

8

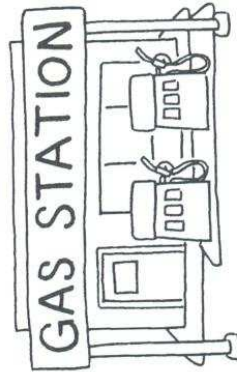

gas station

8

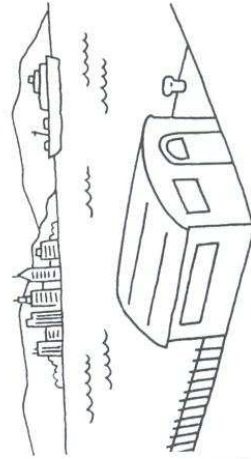

harbor

8

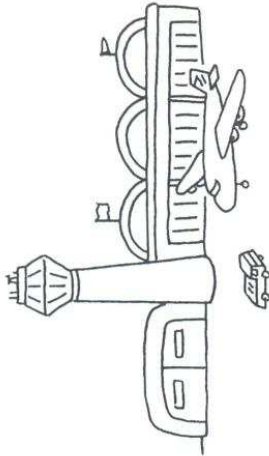

airport

8



bridge

9

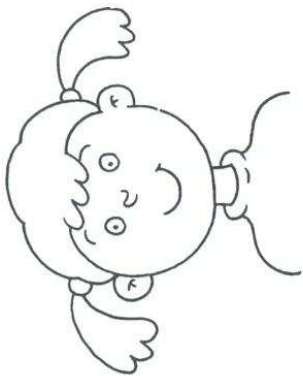

sister

9

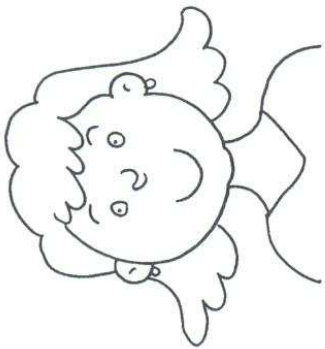

mom

9

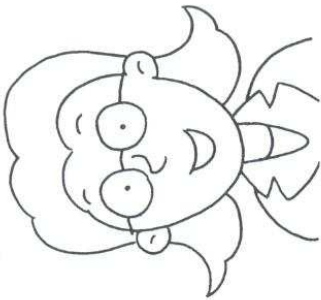

aunt

9

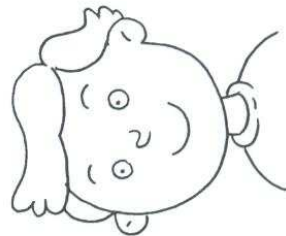

brother

9

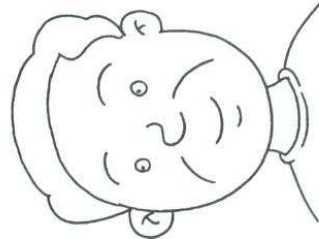

dad

9

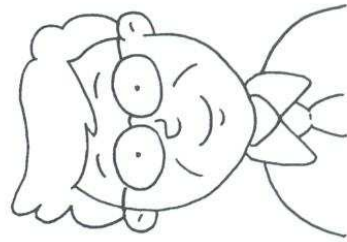

uncle

9

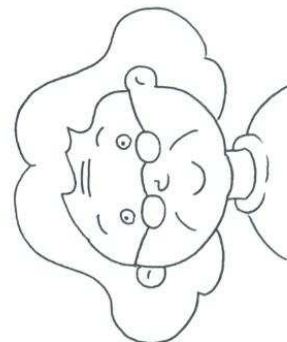

grandma

9

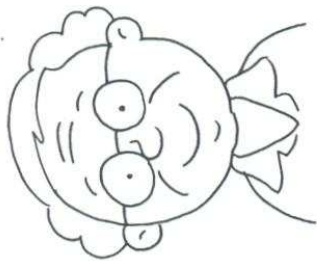

grandpa

9

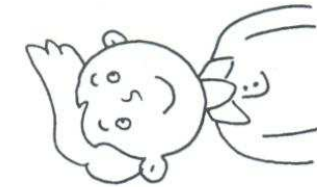

cousins

9

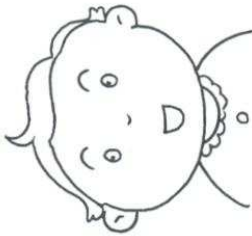

baby

10



shower

10

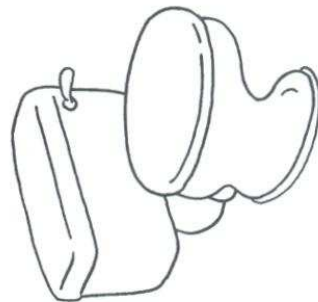

toilet

10

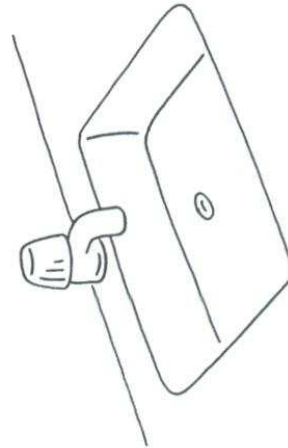

sink

10

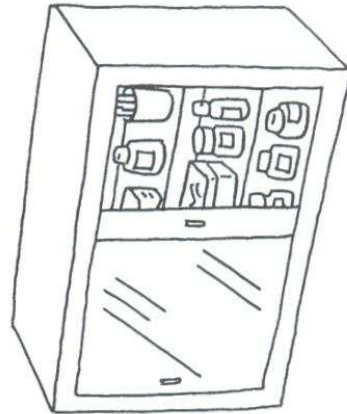

cabinet

10

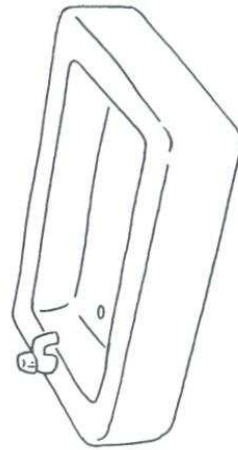

bathtub

10

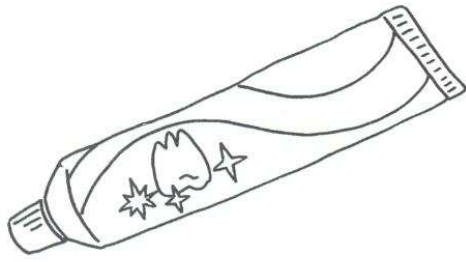

toothpaste

10

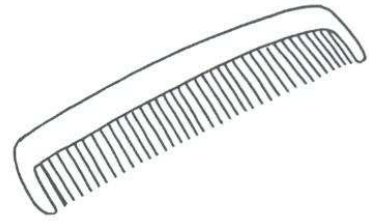

comb

10



toothbrush

10



hairbrush

10

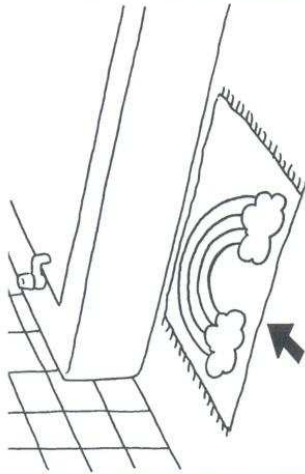

bath mat

10

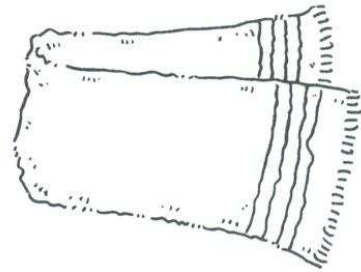

towel

10

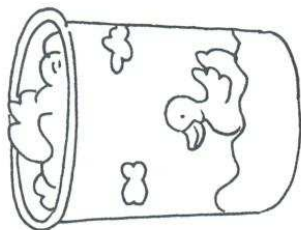

wastebasket

10

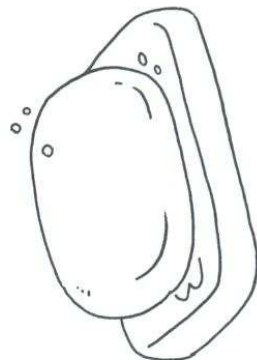

soap

10

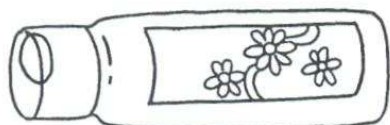

shampoo

11



eggs

11



toast

11

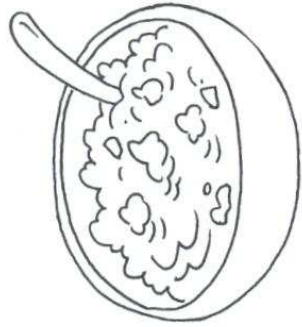

cereal

11

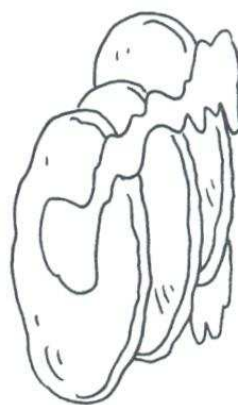

pancakes

11

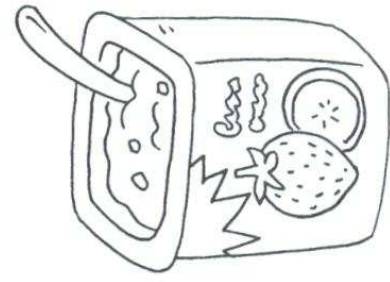

yogurt

11



milk

11

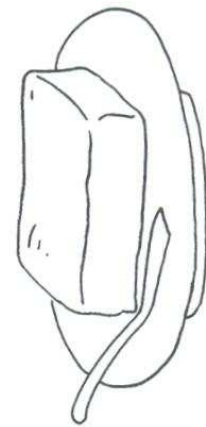

butter

11

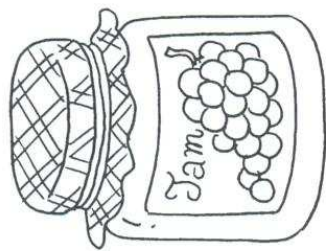

jam

11

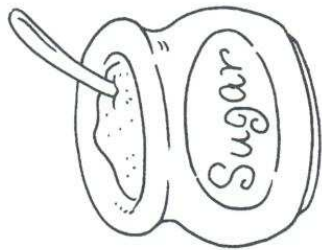

sugar

11

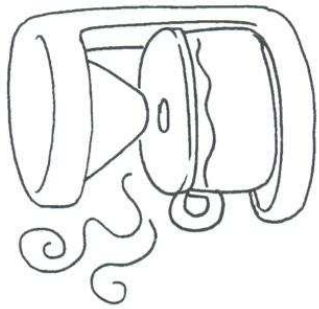

coffee

11

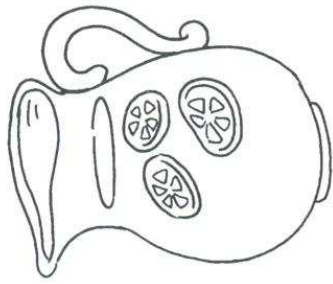

orange juice

11



cup

11



saucer

11

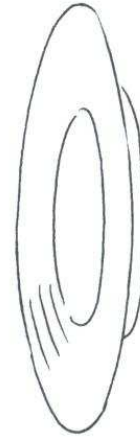

plate

11

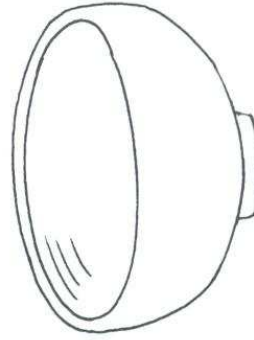

bowl



11

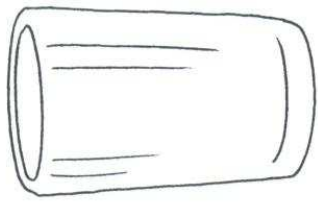

glass

11



newspaper

11

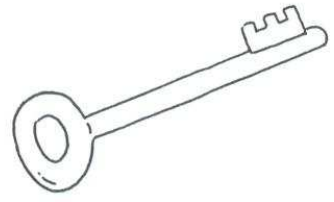

key

11

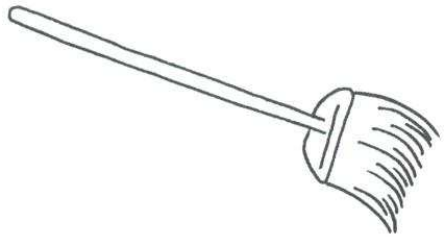

broom

12

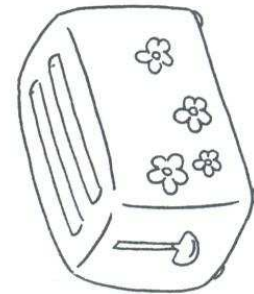

toaster

12

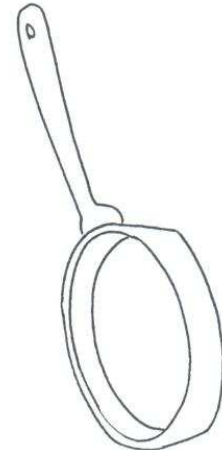

frying pan

12

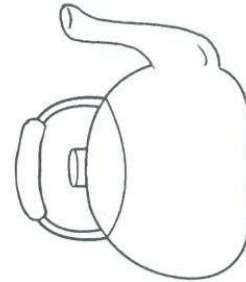

teakettle

12

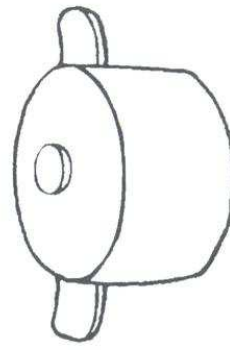

pot

12

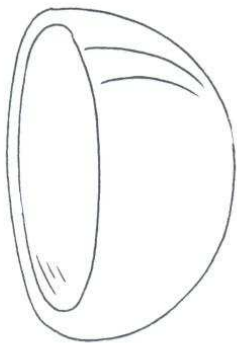

mixing bowl

12

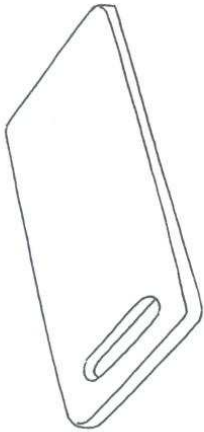

cutting board

12

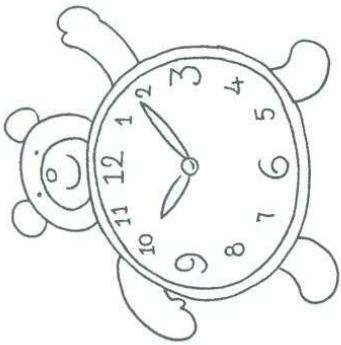

clock

12

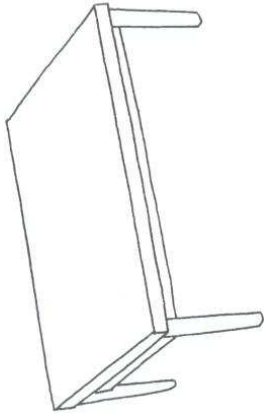

table

12

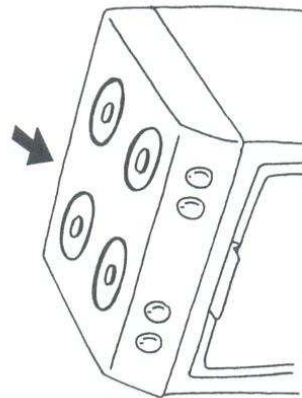

stove

12

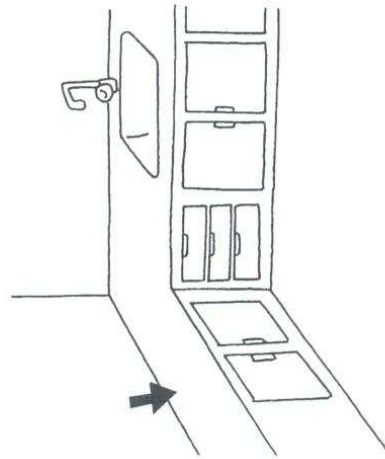

counter

12

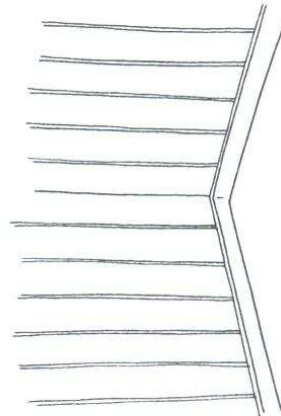

wall

12

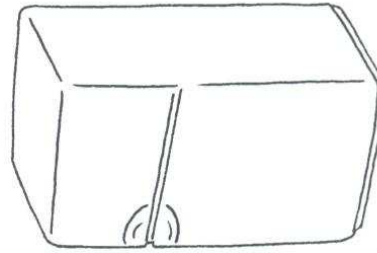

refrigerator

12

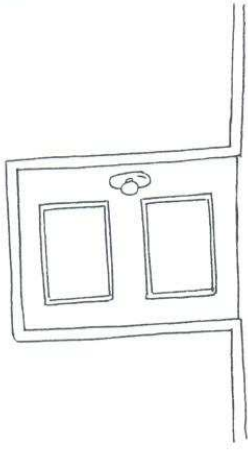

door

13

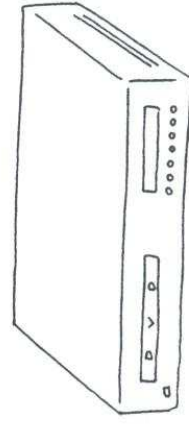

DVD player

12

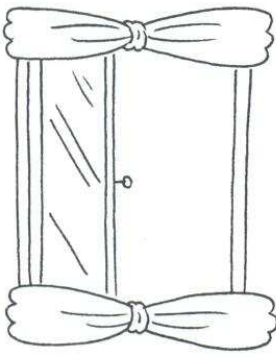

window

13

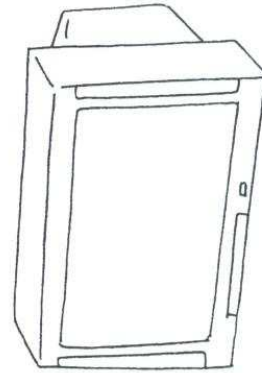

television

12

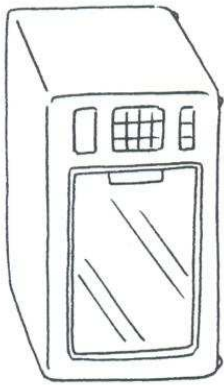

microwave

12

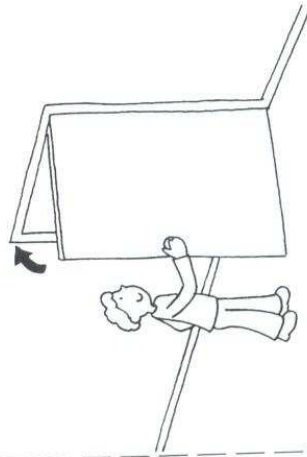

close

12

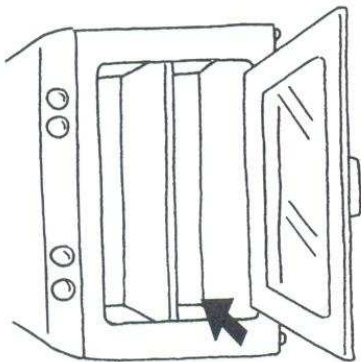

oven

12

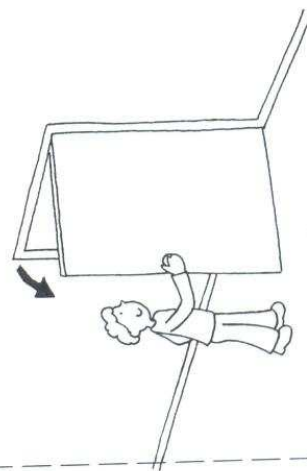

open

13

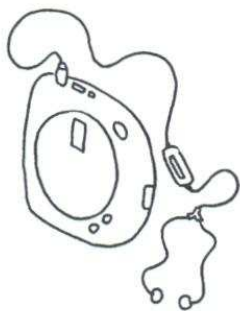

CD player

13

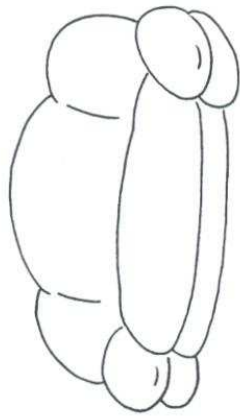

sofa

13

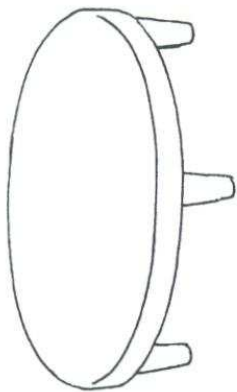

coffee table

13

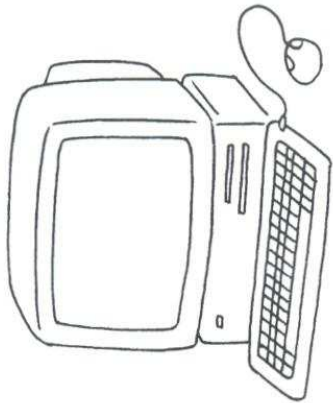

computer

13

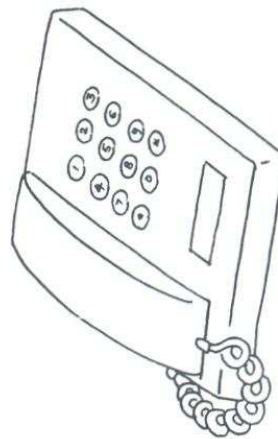

telephone

13



magazine

13

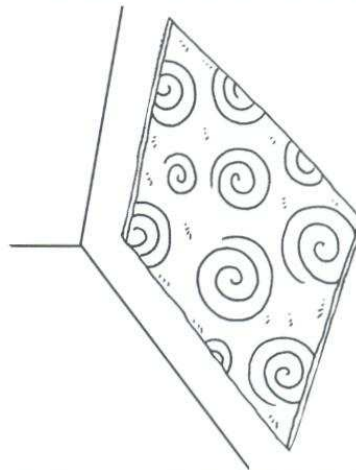

carpet

13



vacuum cleaner

13



armchair

13

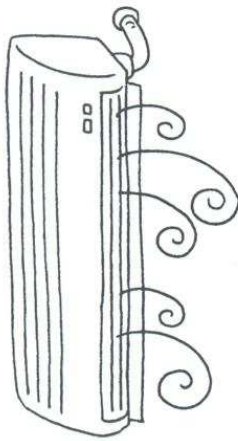

air conditioner

13

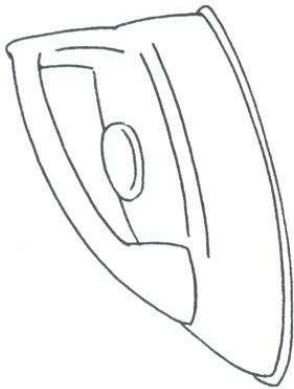

iron

13

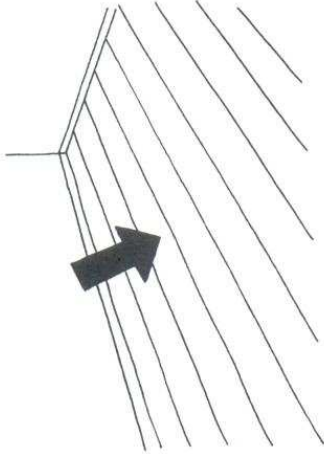

floor

13



homework

14

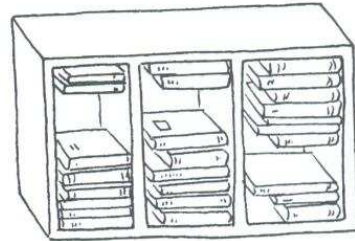

bookcase

14

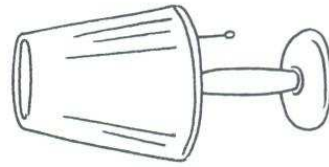

lamp

14

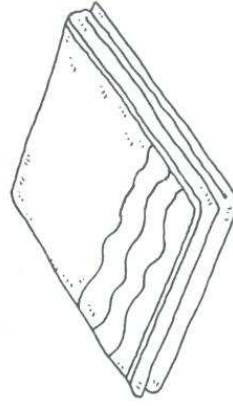

blanket

14

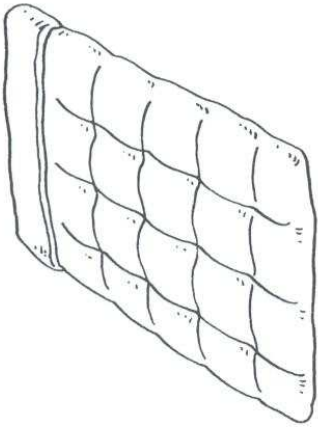

quilt

14



pillow

14

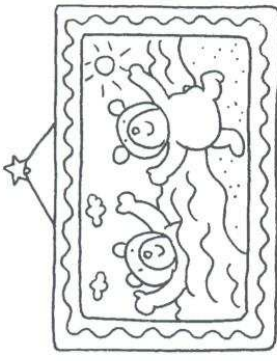

picture

14

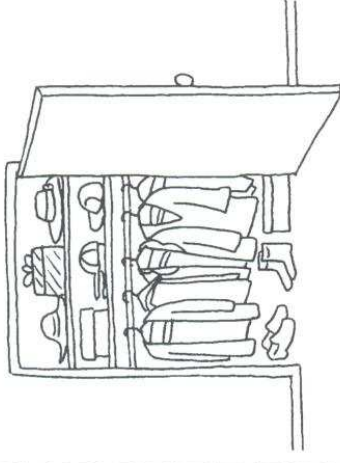

closet

14

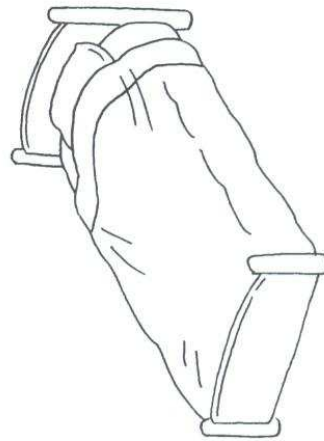

bed

14

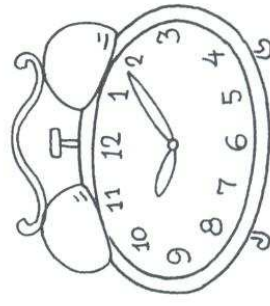

alarm clock

14

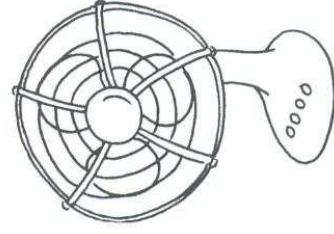

electric fan

14

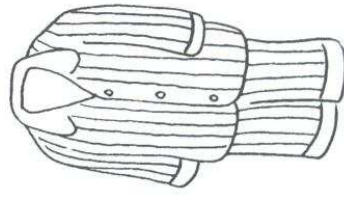

pajamas

14

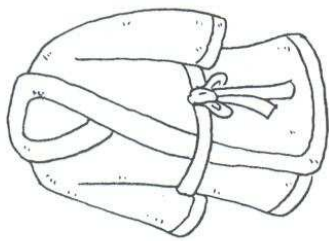

bathrobe

14

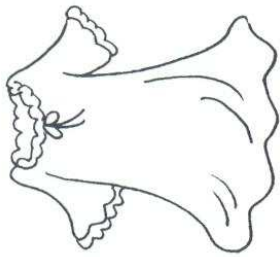

nightgown

14

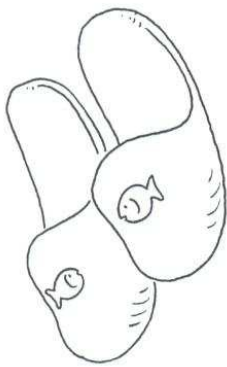

slippers

14

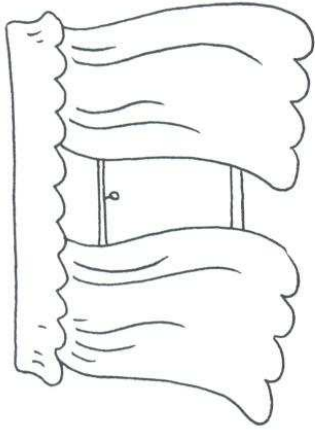

curtains

15

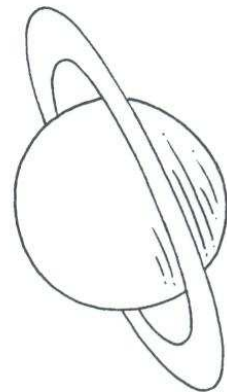

planet

15

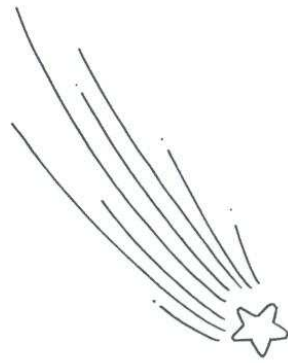

shooting star

15

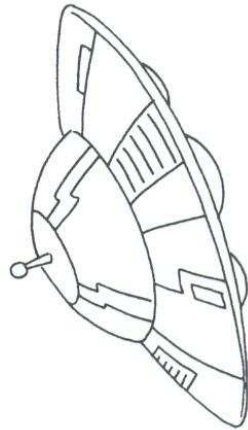

spaceship

15



comet

15

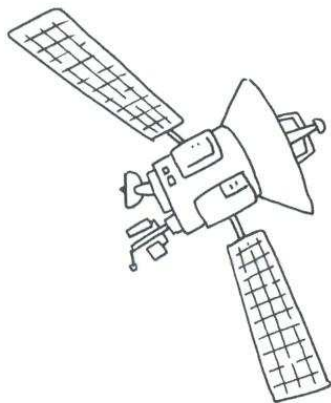

satellite

moon

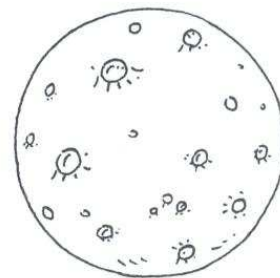

15

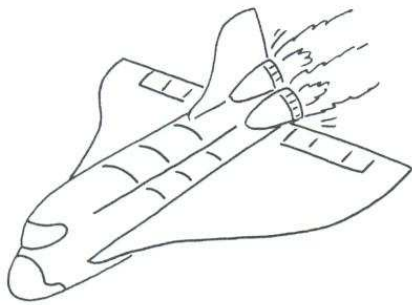

space shuttle

stars



15

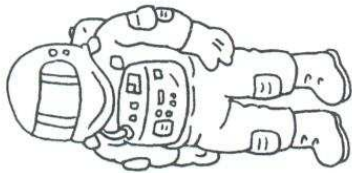

astronaut

earth



15

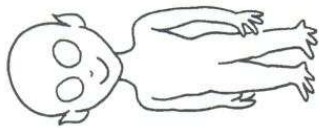

alien

Big Dipper



15

15

15

15



15

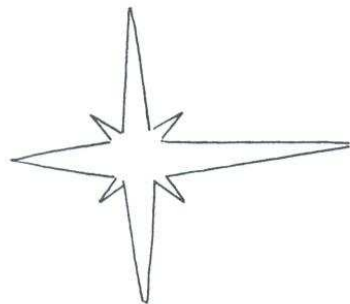

North Star

15

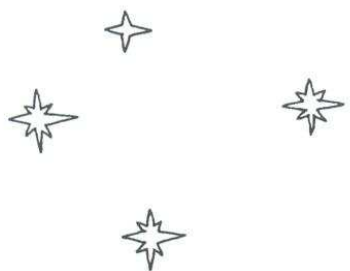

Southern Cross

15

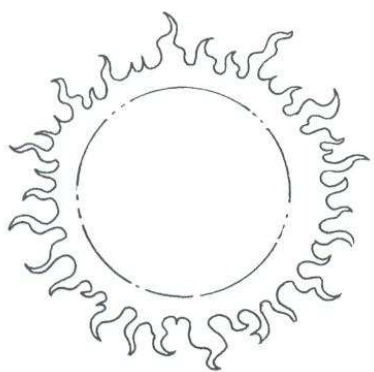

sun

16

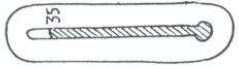

hot

16

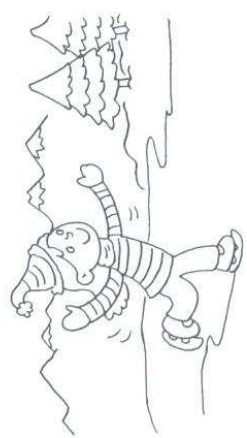
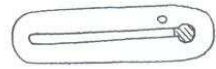

cold

16

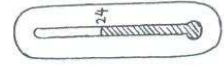

warm

16

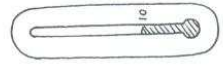

cool

16



snowy

16



rainy

16

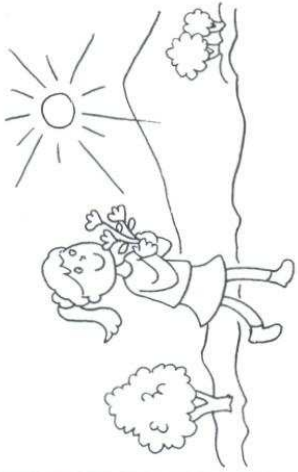

sunny

16

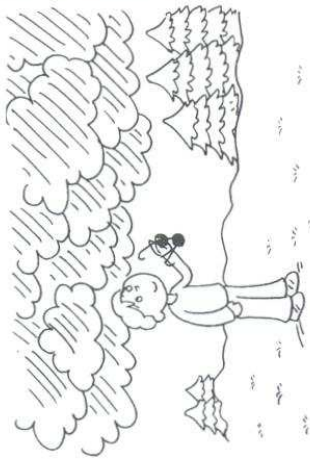

cloudy

16



foggy

16



windy

16



stormy

16



thunder

16

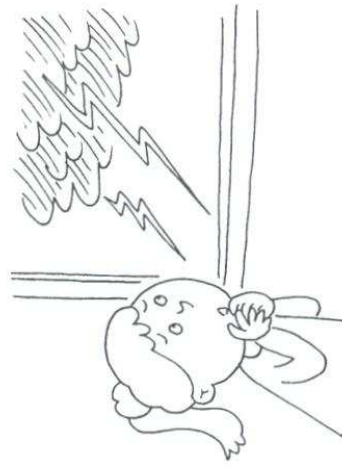

lightning

17

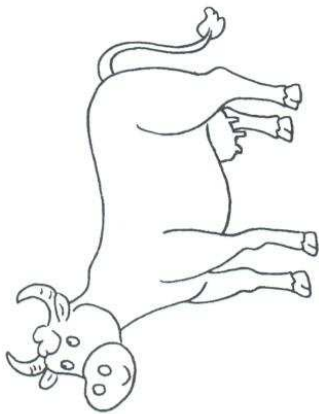

cow

17

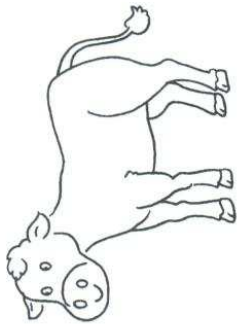

calf

17

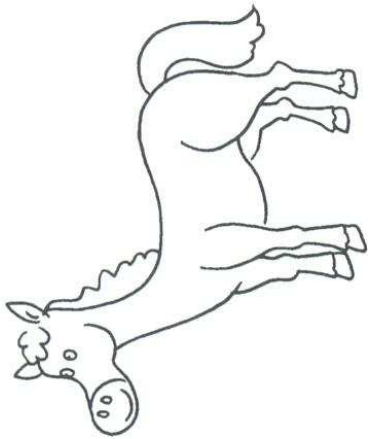

horse

17

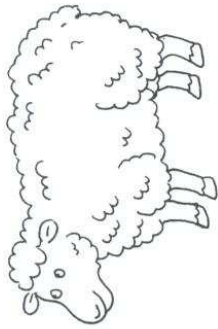

sheep

17

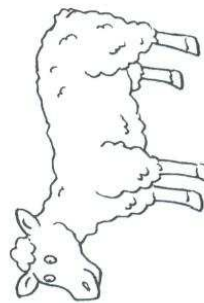

lamb

17

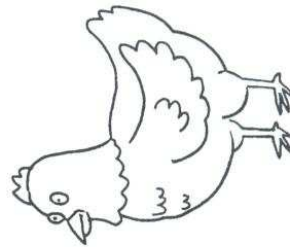

hen

17

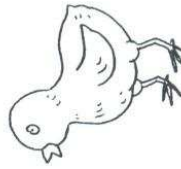

chick

17

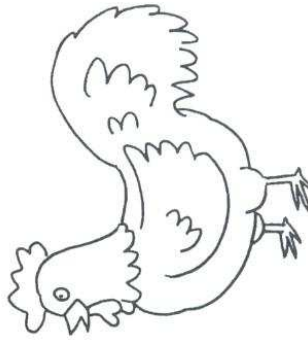

rooster

17

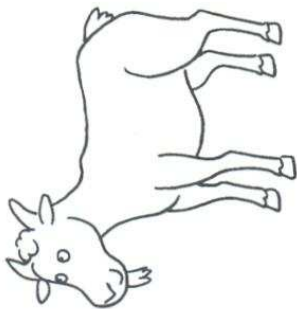

goat

barn

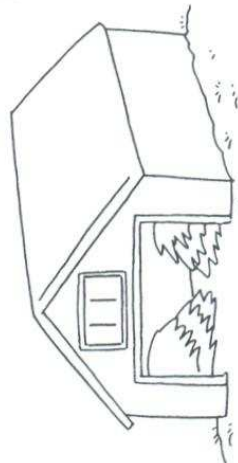

17

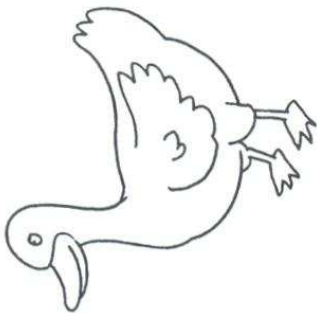

duck

tractor

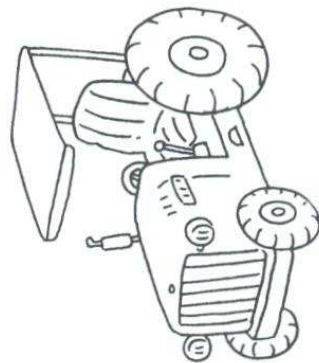

17

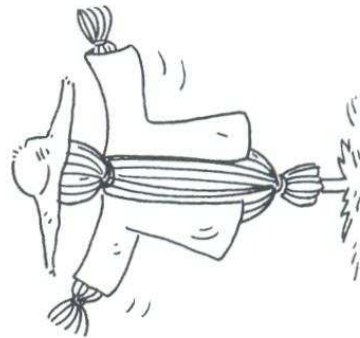

scarecrow

17

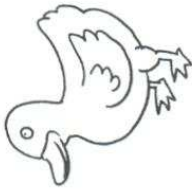

duckling

flowers

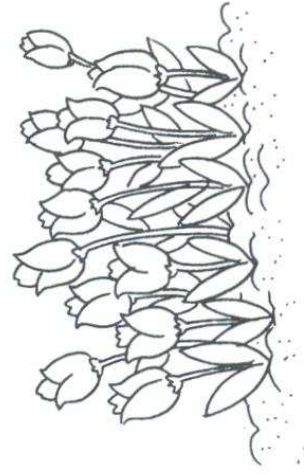

17

17

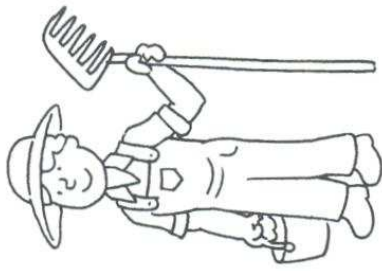

farmer

18

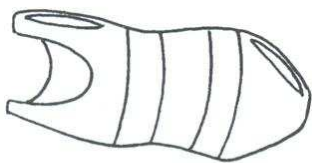

bathing suit

18



sunglasses

18

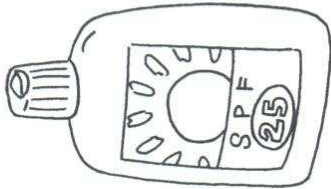

sunscreen

18

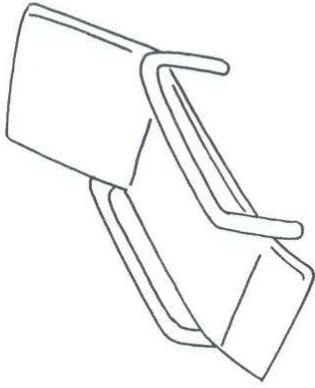

beach chair

18

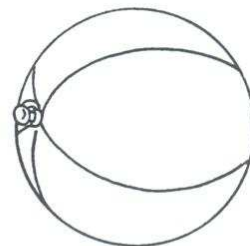

beach ball

18

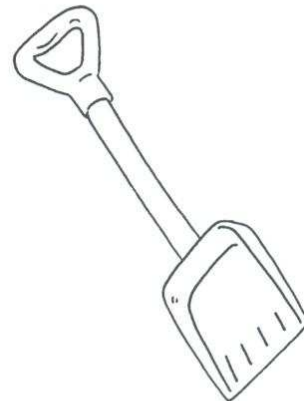

shovel

18

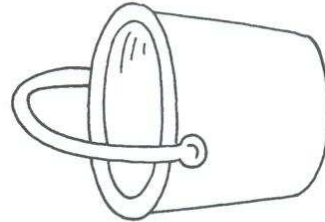

pail

18

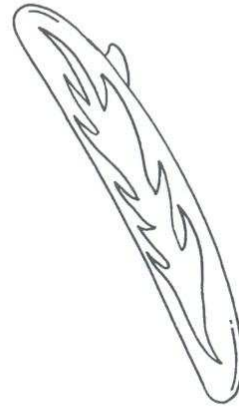

surfboard

18

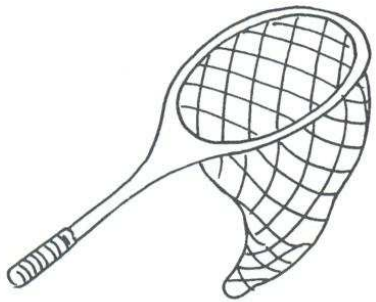

fishing net

18



mask

18

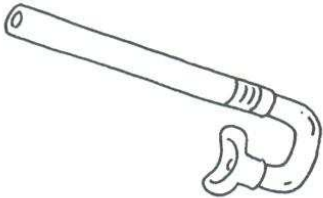

snorkel

18

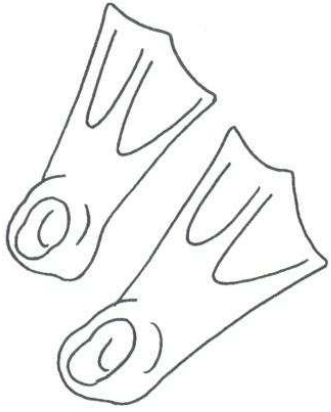

fins

18

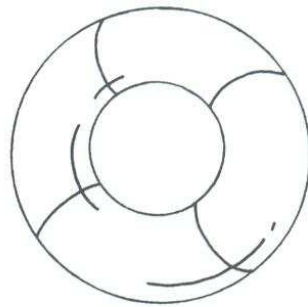

lifesaver

18

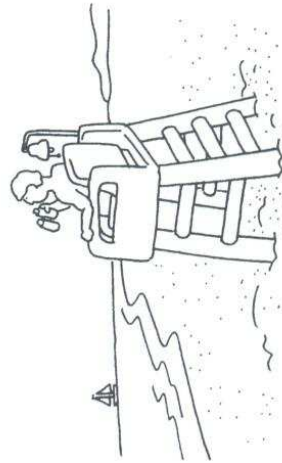

lifeguard

18

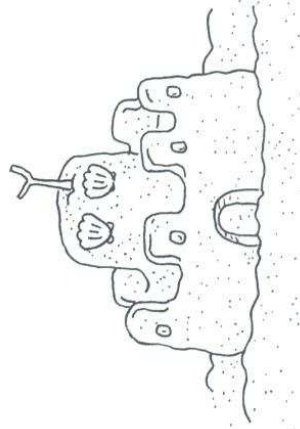

sandcastle

19

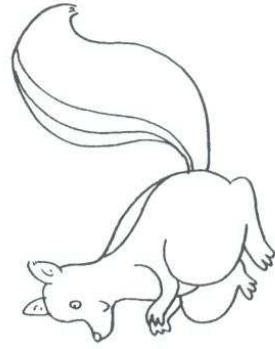

squirrel

19

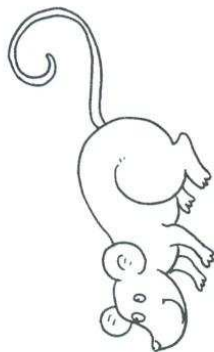

mouse

19



raccoon

19

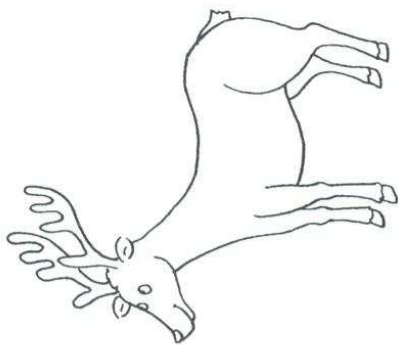

deer

19

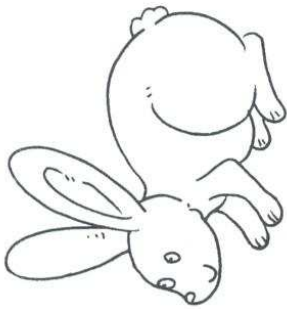

rabbit

19

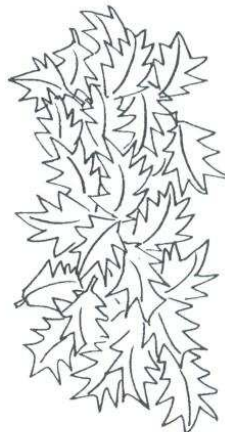

leaves

19

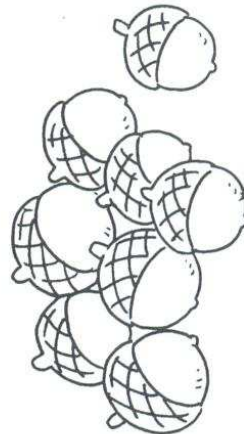

acorns

19

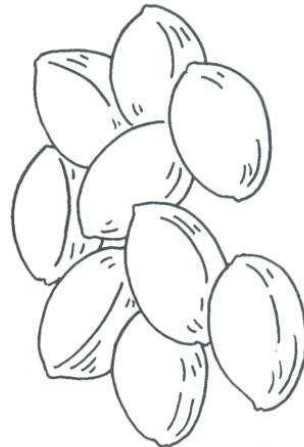

nuts

19



seeds

19

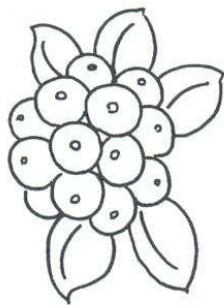

berries

19

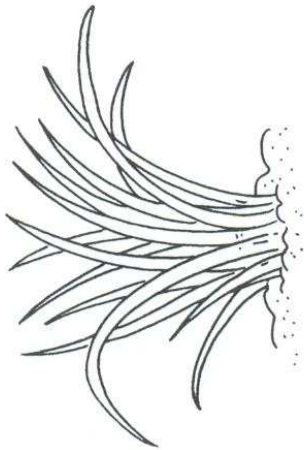

grass

19

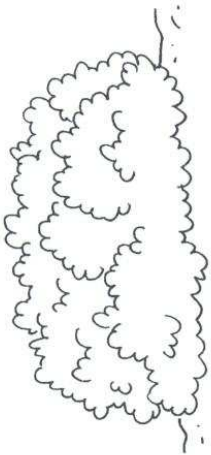

bush

19



tree

20

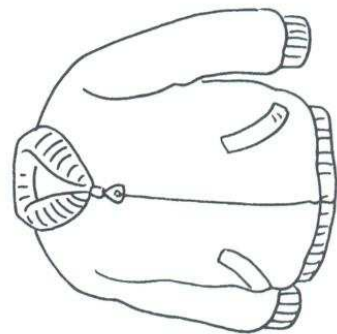

jacket

20



boots

20

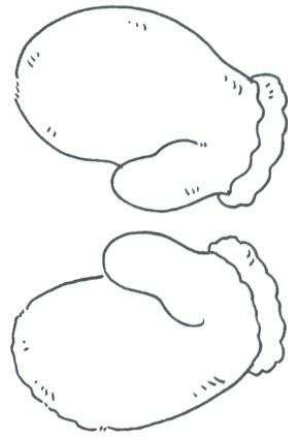

mittens

20



scarf



20

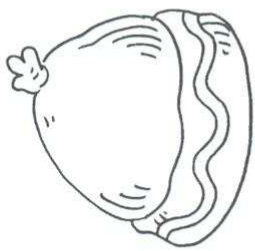

hat

20

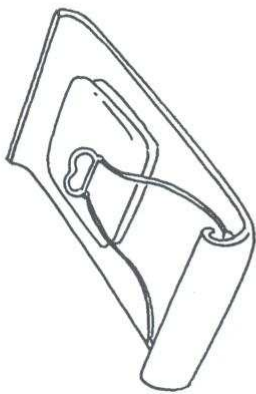

sled

20

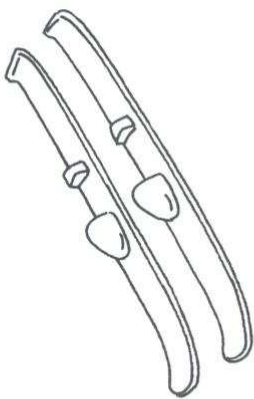

skis

20

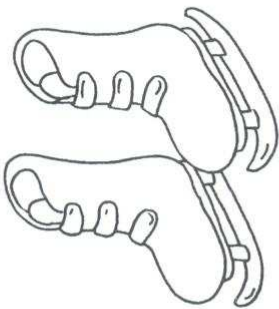

ice skates

20

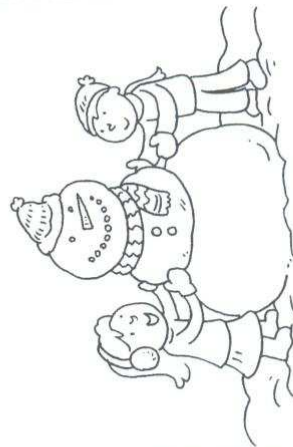

make a snowman

20



have a snowball fight

20



go skiing

20



go sledding

20



go ice-skating

20

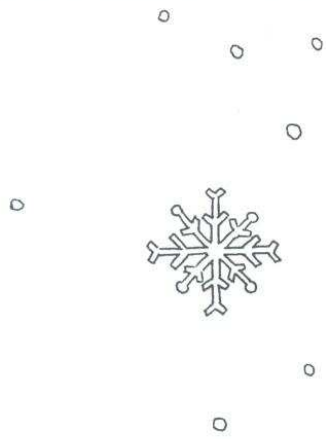

snowflake

20

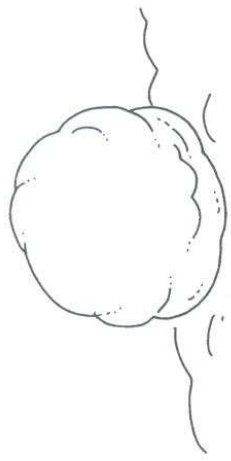

snowball

20

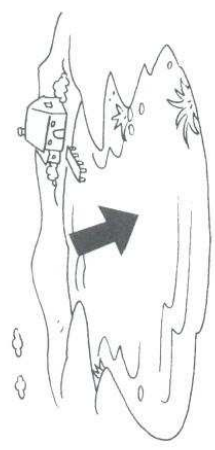

pond

20

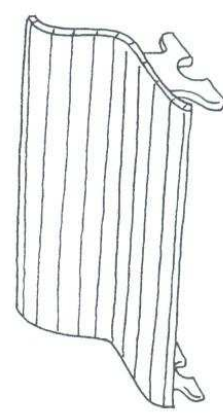

bench

21

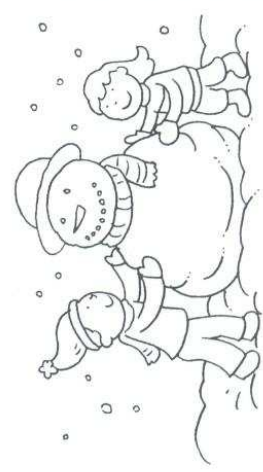

January

21

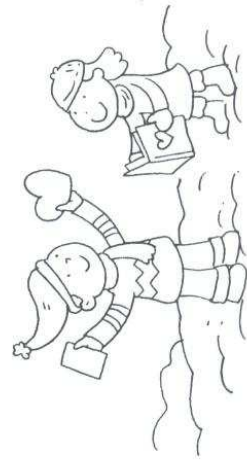

February

21

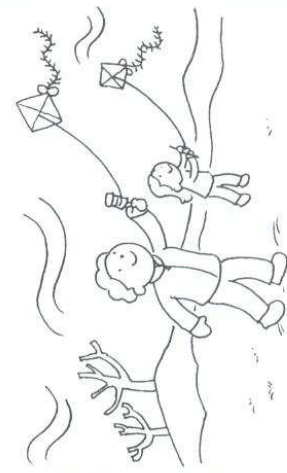

March

21



April

21



May

21

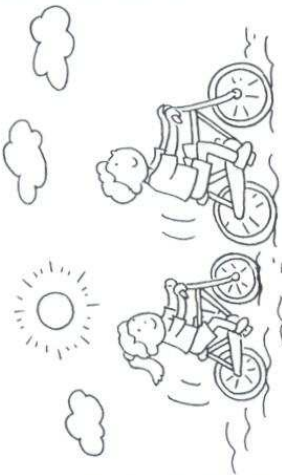

June

21

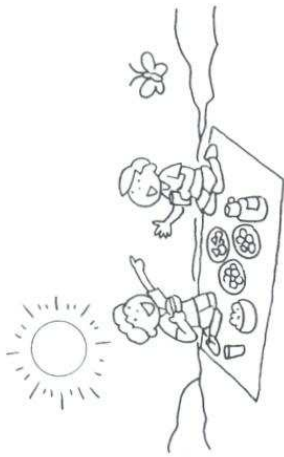

July

21



August

21



September

21



October

21



November

21



December

winter

21



spring

Monday

21

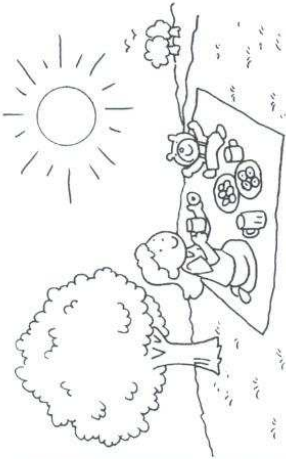

summer

Tuesday

21



fall

Wednesday

21



winter

22



Monday

Monday

22



Tuesday

Tuesday

22



Wednesday

Wednesday

22



Thursday

Thursday

22



ballet class

22



Friday

Friday

22

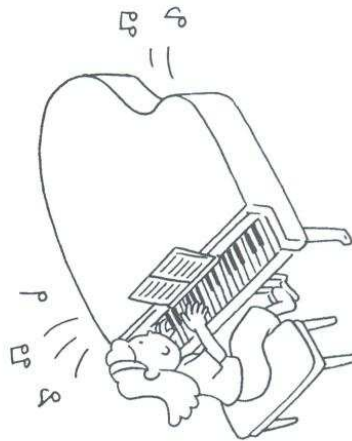

piano class

22



Saturday

Saturday

22



karate class

22



Sunday

Sunday

22



swimming class

22

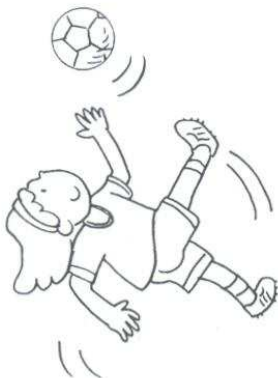

soccer practice

22

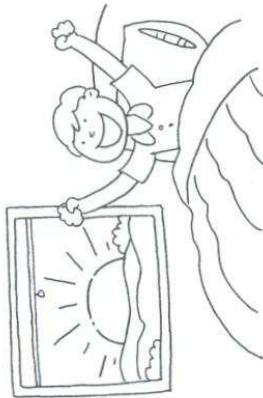

morning

22



afternoon

22



evening

22

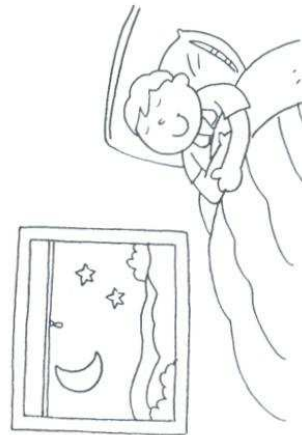

night

23

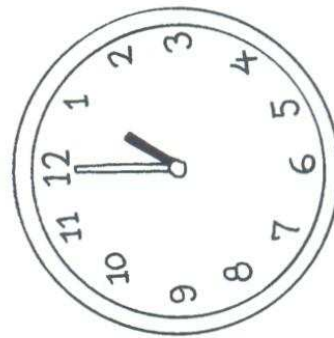

one o'clock

23

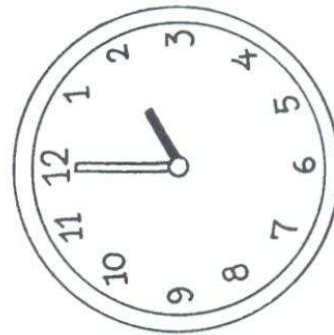

two o'clock

23

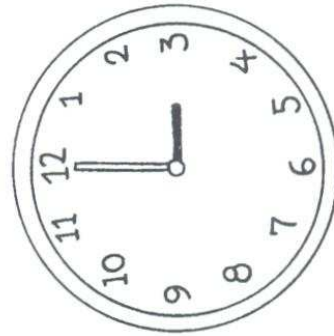

three o'clock

23

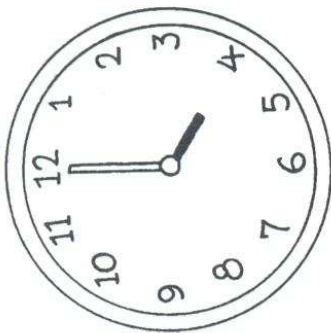

four o'clock

23



five o'clock

23

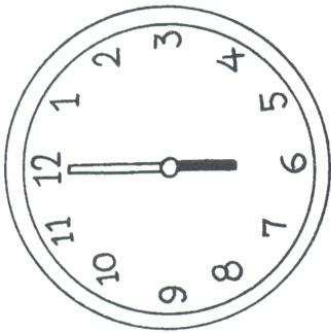

six o'clock

23



seven o'clock

23

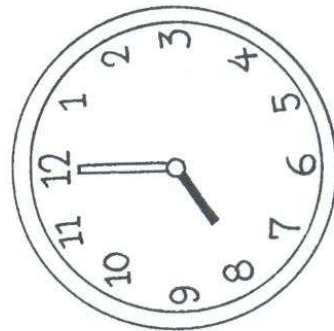

eight o'clock

23

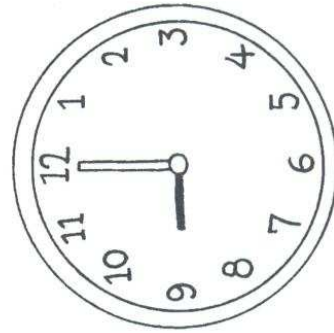

nine o'clock

23



ten o'clock

23

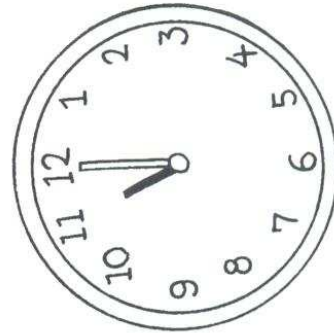

eleven o'clock

23

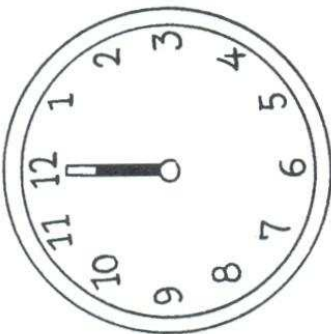

twelve o'clock

23

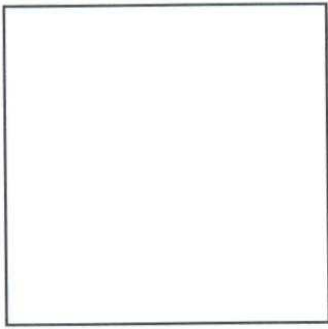

square

23

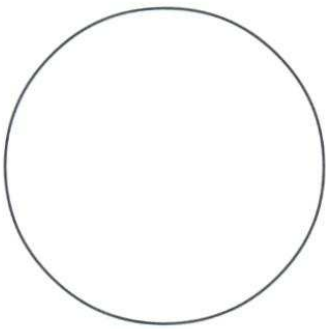

circle

23

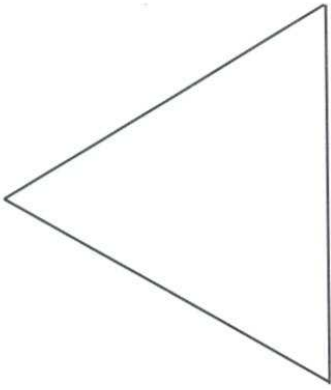

triangle

23

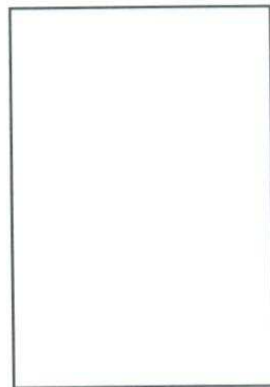

rectangle

23

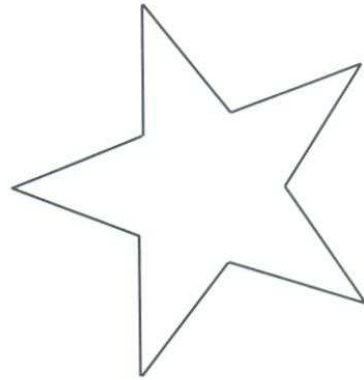

star

23

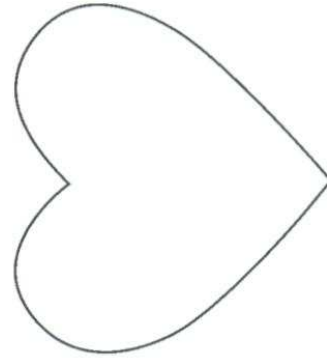

heart

24

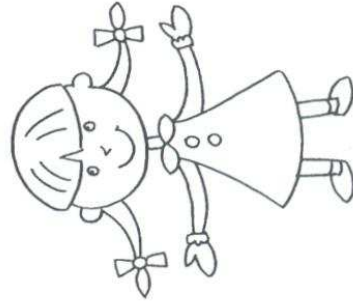

doll



24

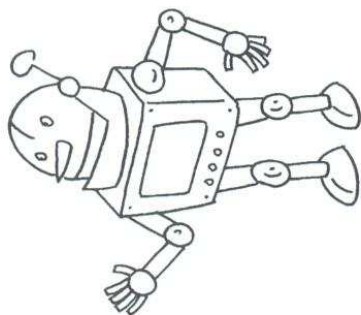

robot

24

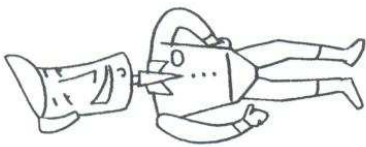

action figure

24

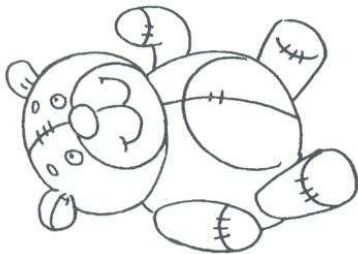

teddy bear

24

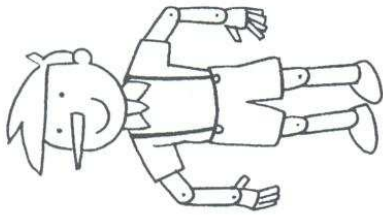

puppet

24

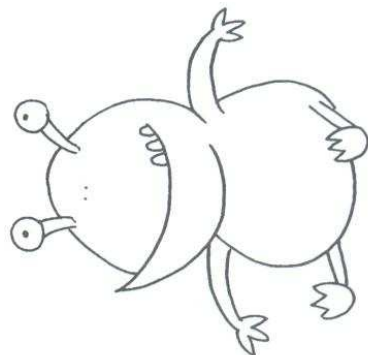

monster

24



panda

24



gorilla

24

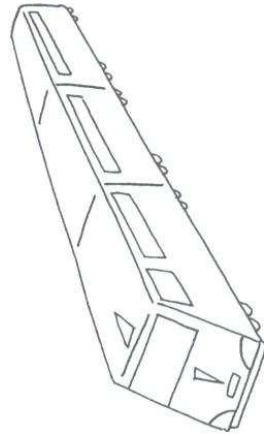

train

24

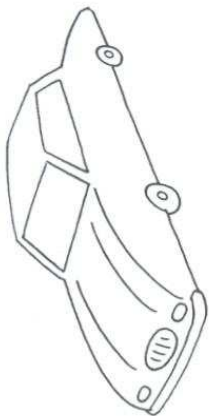

car

24

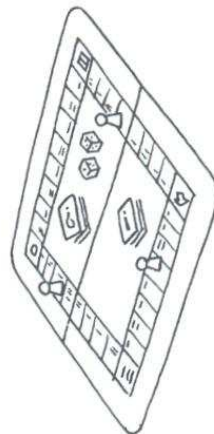

board game

24

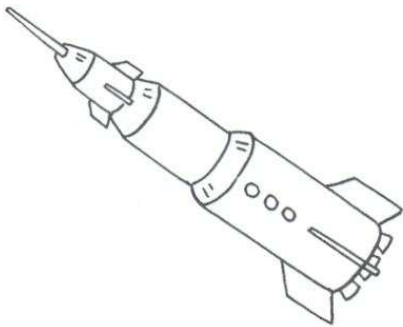

rocket

24

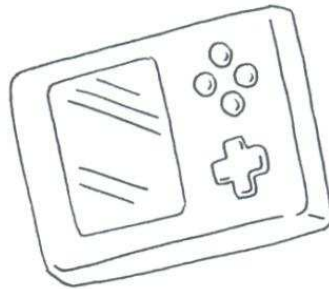

computer game

24

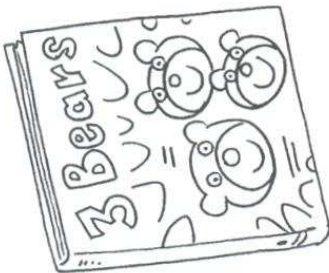

book

24

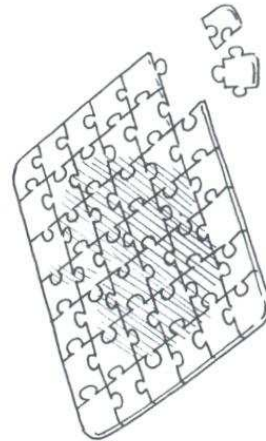

puzzle

24



comic book

24

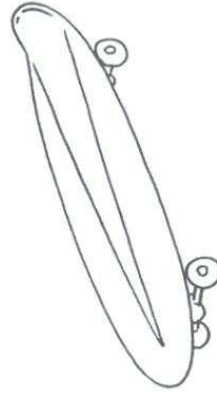

skateboard

24

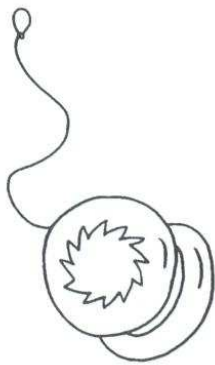

yo-yo

25

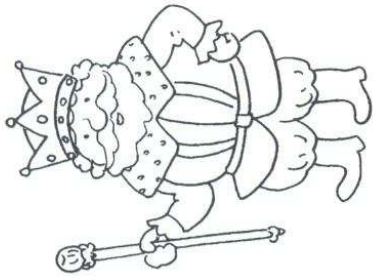

king

25



queen

25

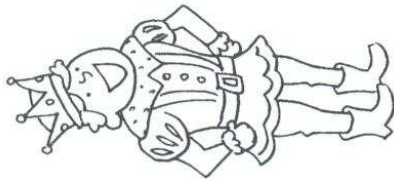

prince

25



princess

25

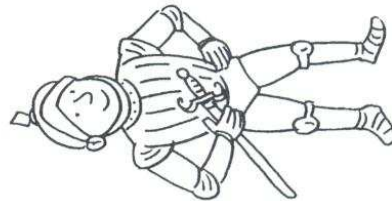

knight

25

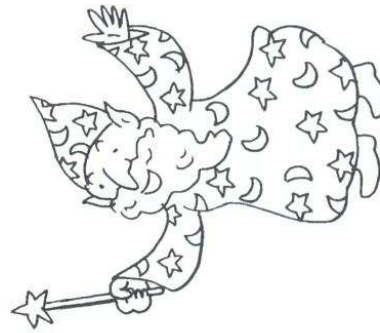

wizard

25



jester

25



dragon

25



owl

25

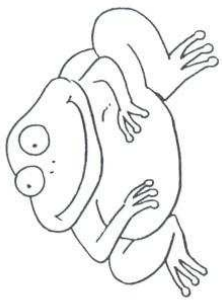

frog

25

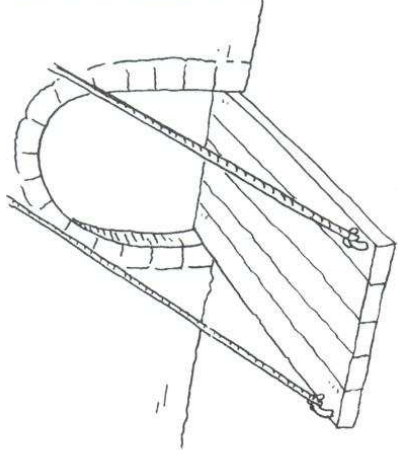

drawbridge

25

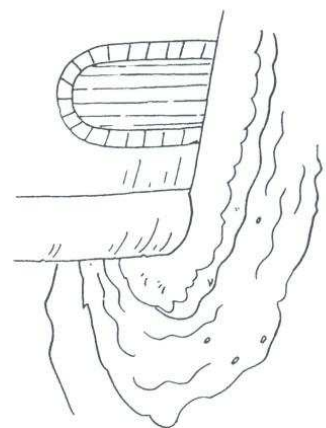

moat

25

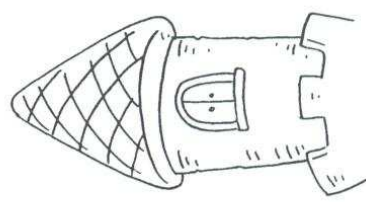

tower

25

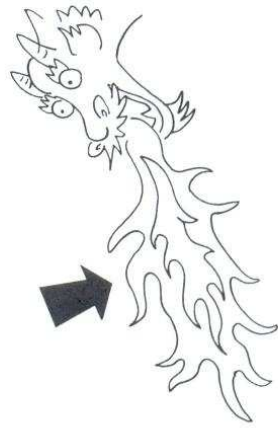

fire

25

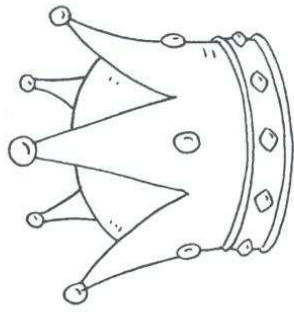

crown

25

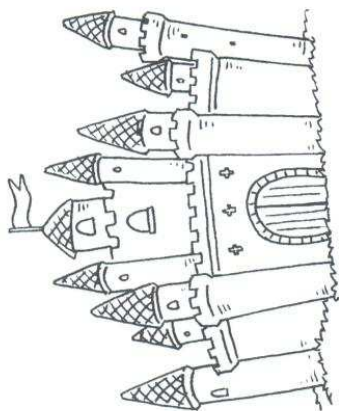

castle

26

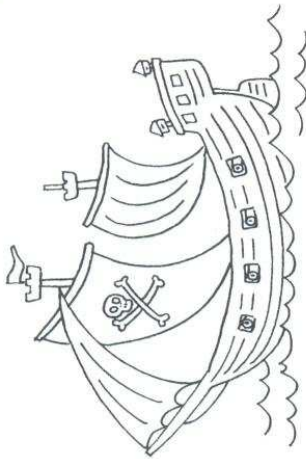

pirate ship

26

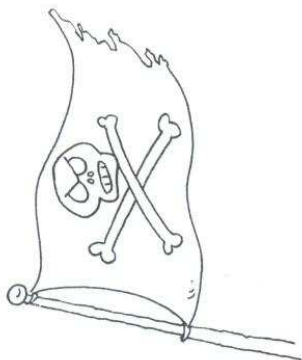

pirate flag

26



treasure map

26

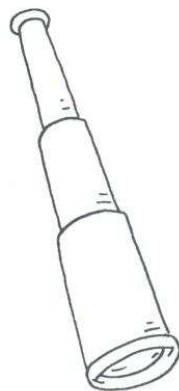

telescope

26

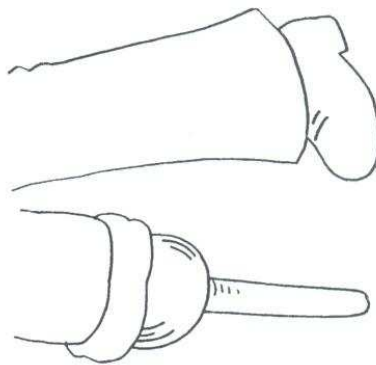

wooden leg

26

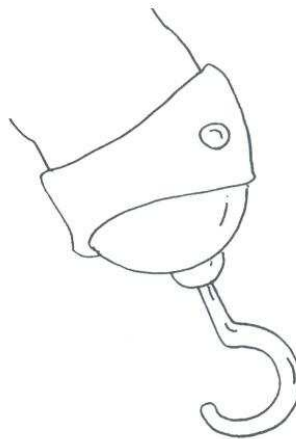

hook

26

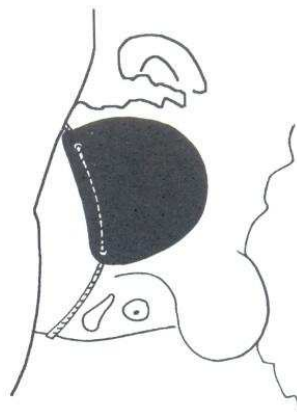

eye patch

26



cave

26



volcano

26

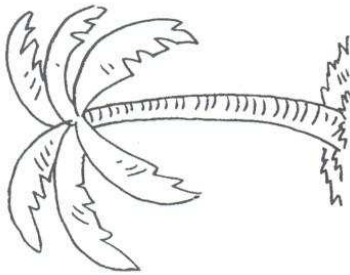

palm tree

26

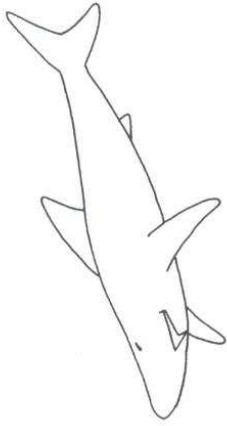

shark

26

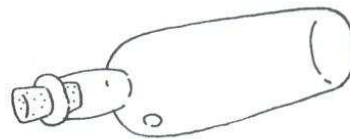

bottle

26

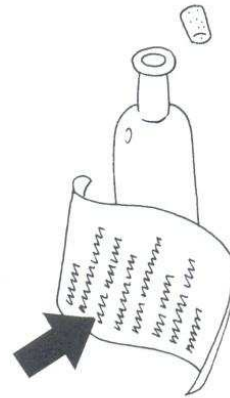

message

26

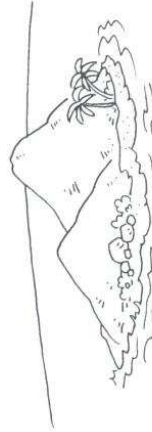

island

26



pirate captain

27

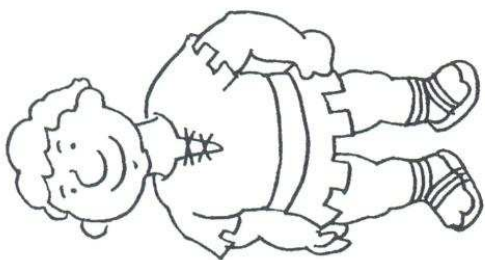

giant

27

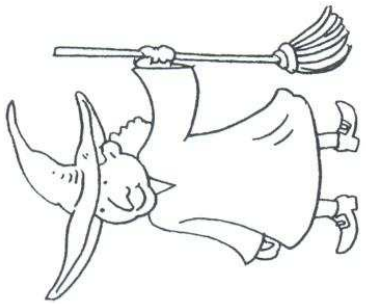

witch

27



dwarf

27



genie

27



fairy

27

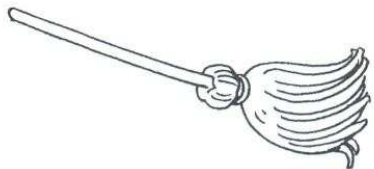

broomstick

27

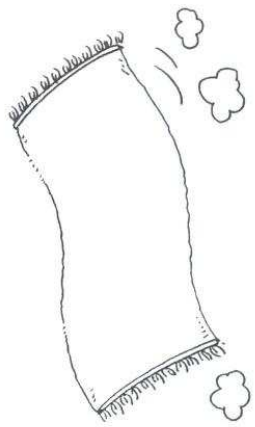

flying carpet

27

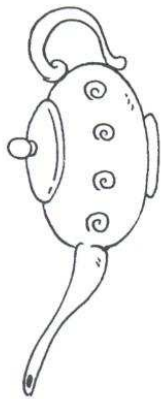

lamp

27

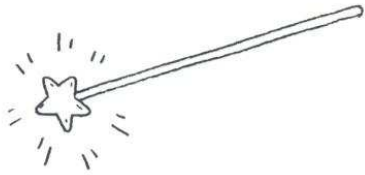

magic wand

27

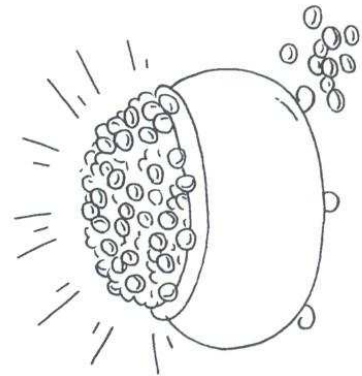

pot of gold

27

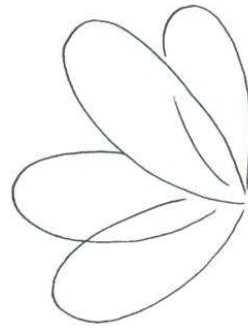

wings

27

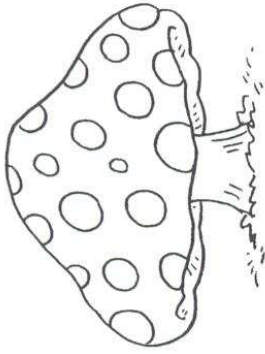

toadstool

28

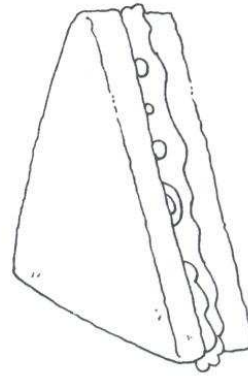

sandwich

27

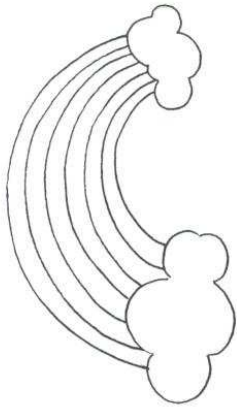

rainbow

28

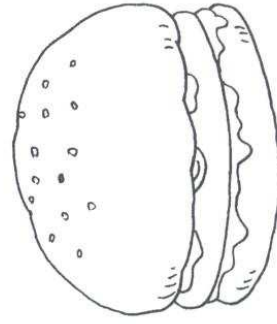

hamburger



28

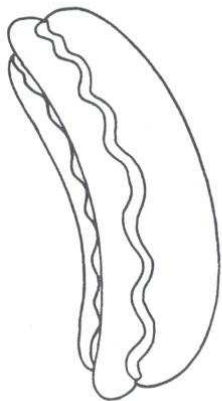

hot dog

28

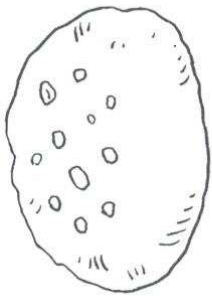

cookie

28

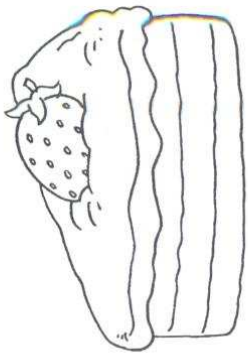

piece of cake

28

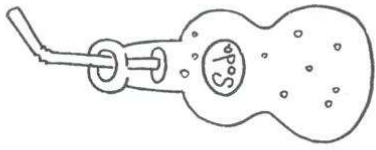

soda pop

28

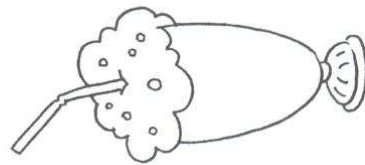

milkshake

28

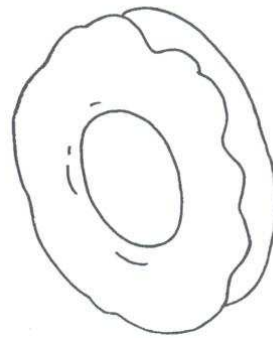

donut

28

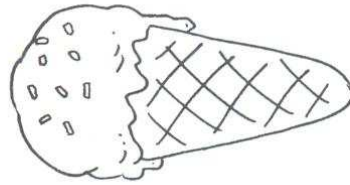

ice cream cone

28

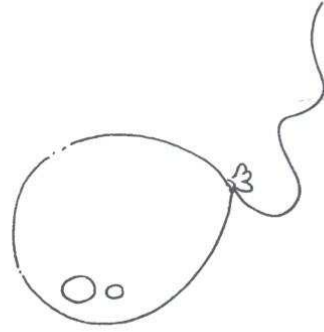

balloon

28

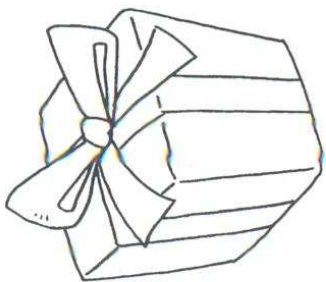

present

28



birthday card

28

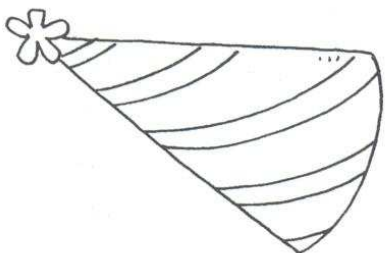

party hat

28

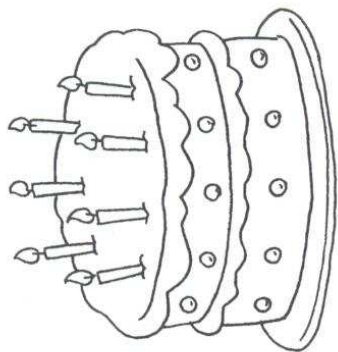

birthday cake

28

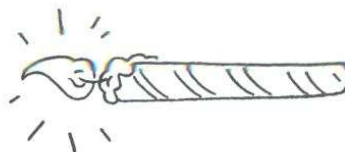

candle

29



water

29

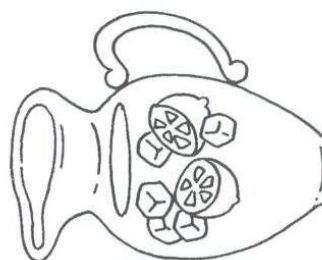

lemonade

29

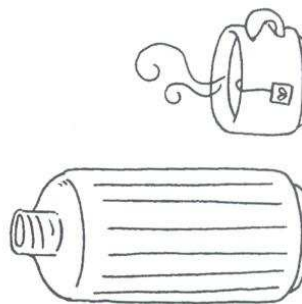

tea

29

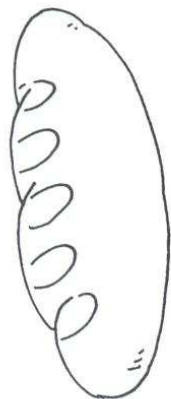

bread

29

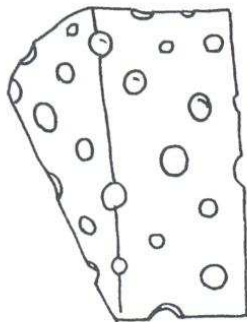

cheese

29

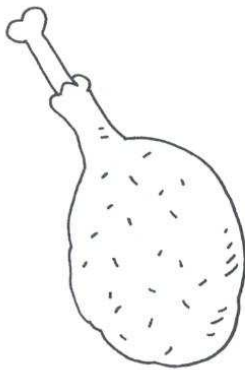

fried chicken

29

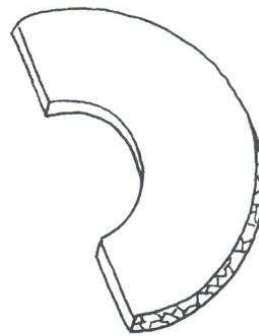

melon

29



pudding

29

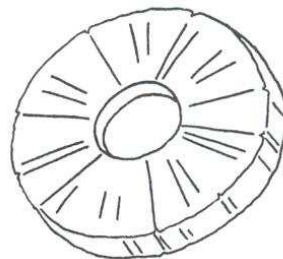

pineapple

29

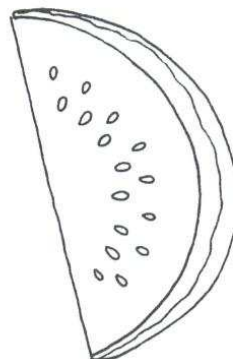

watermelon

29

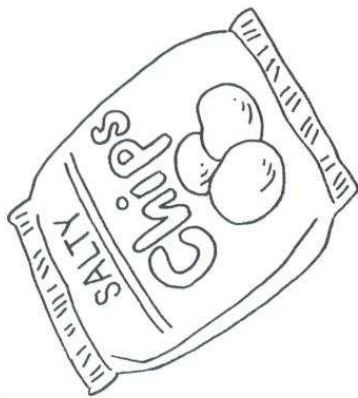

potato chips

29

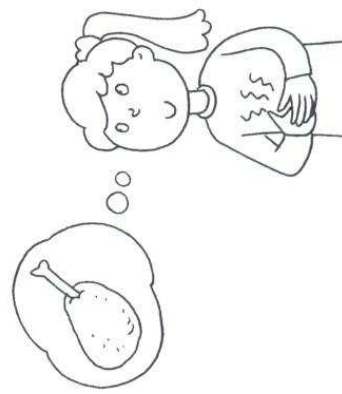

hungry

29

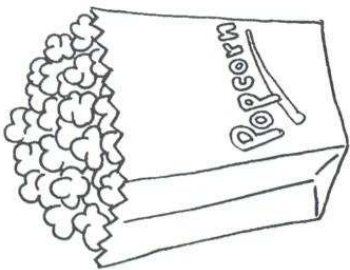

popcorn

29



thirsty

29



candy

30



salad

29

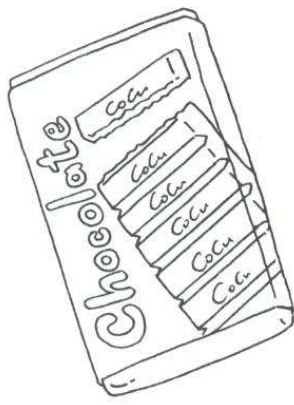

chocolate

30



noodles

30

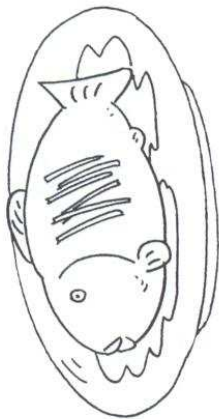

fish

30

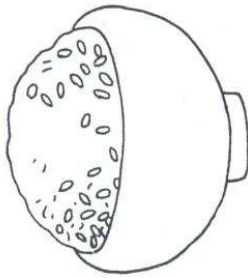

rice

30

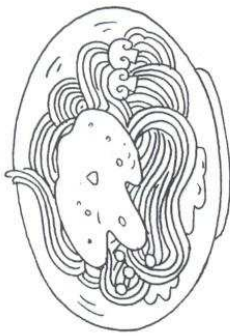

spaghetti

30

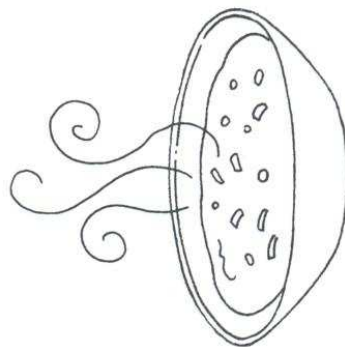

soup

30

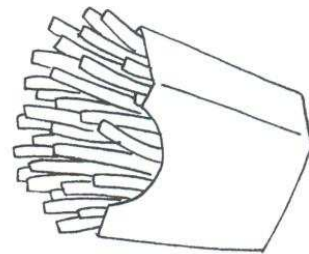

French fries

30

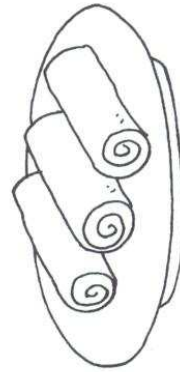

egg rolls

30



beans

30

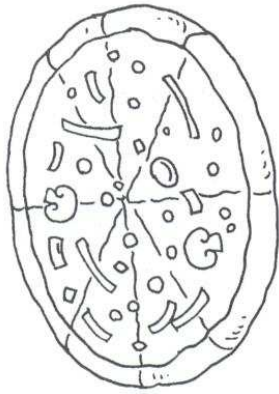

pizza

30



sushi

30

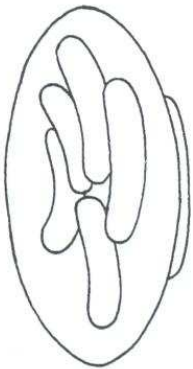

sausages

30

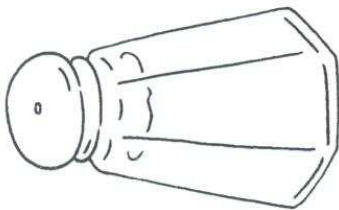

salt

30

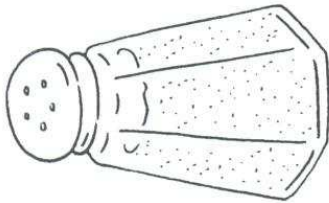

pepper

30

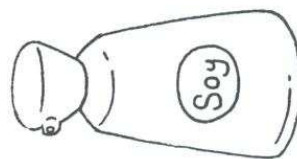

soy sauce

30

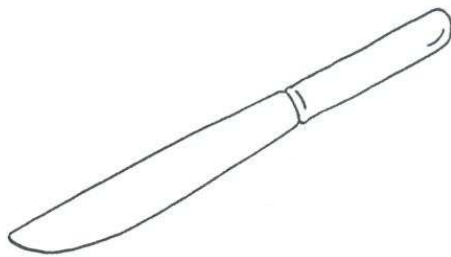

knife

30

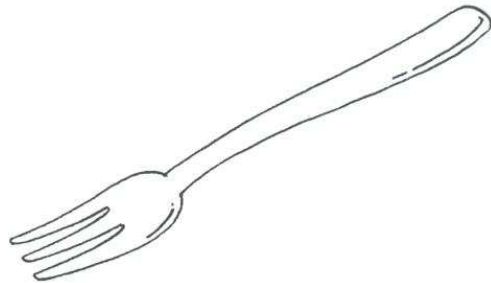

fork

30

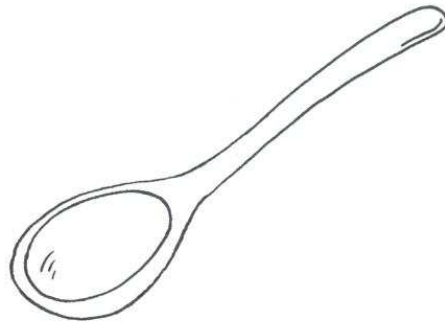

spoon

30



chopsticks

30

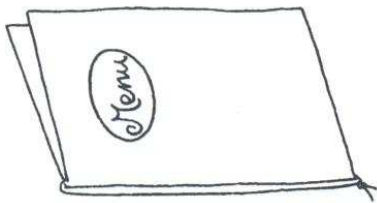

menu

31



hill

31

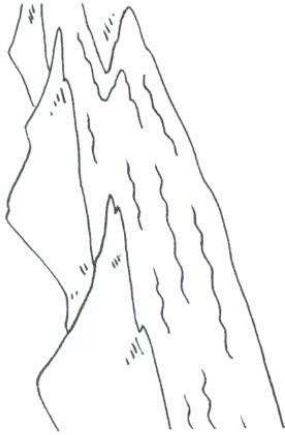

river

31

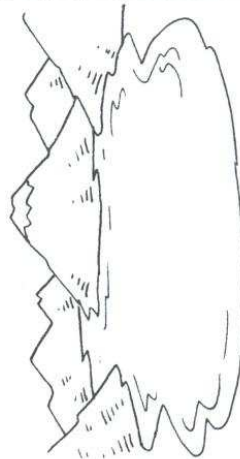

lake

31

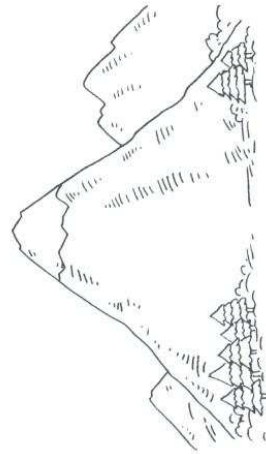

mountain

31



waterfall

31

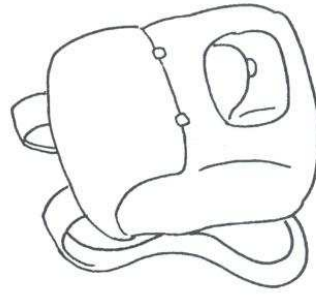

backpack

31

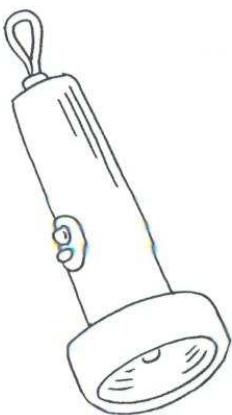

flashlight

31

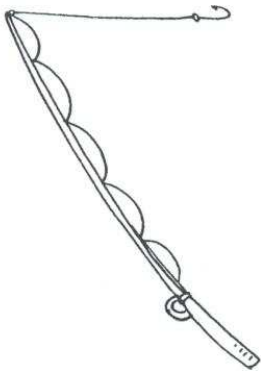

fishing pole

31



sleeping bag

31

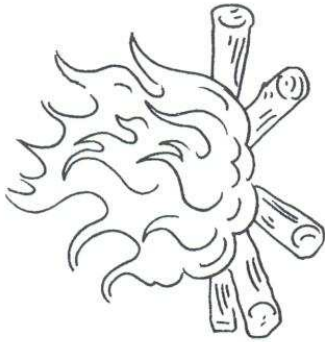

campfire

31

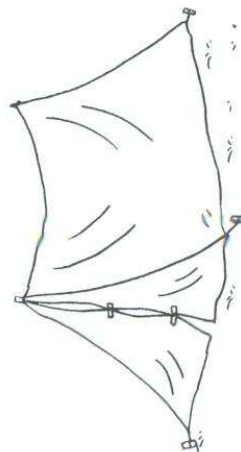

tent

31

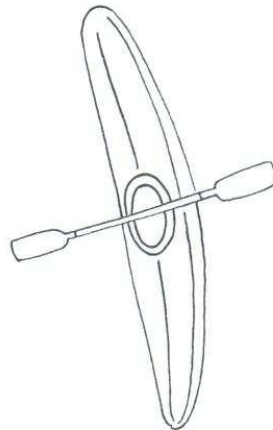

kayak

31



go swimming

31



go fishing



31



go kayaking

31



go hiking

31

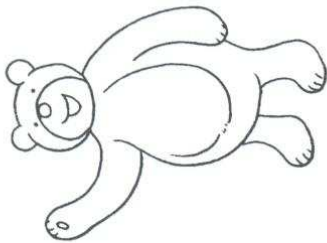

bear

32

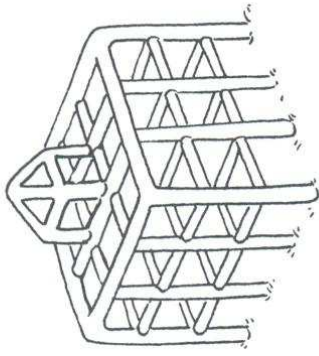

jungle gym

32

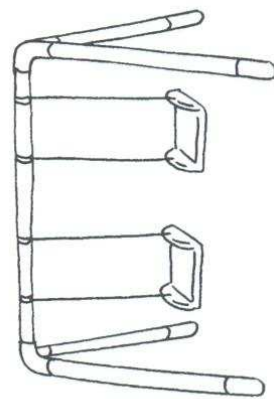

swings

32

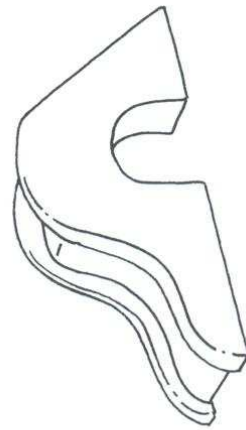

slide

32

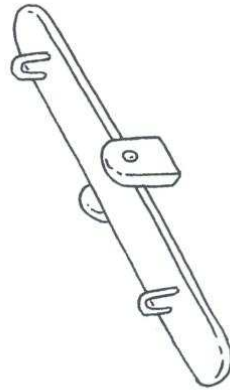

seesaw

32

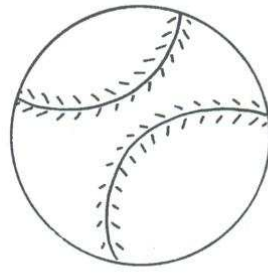

ball

32

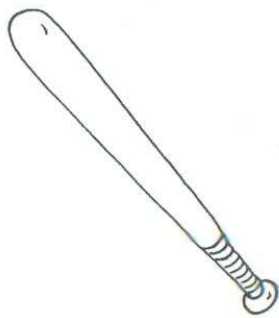

bat

32

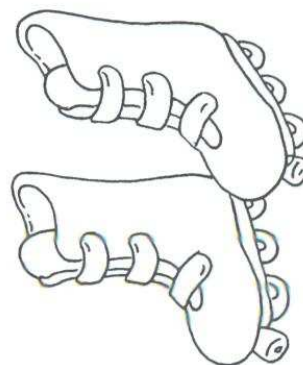

in-line skates

32



glove

32



bike

32

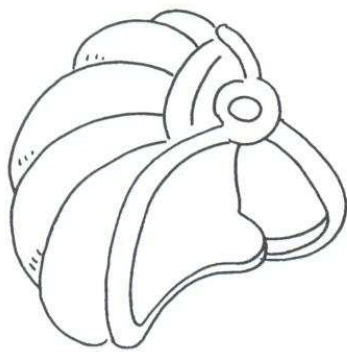

helmet

32

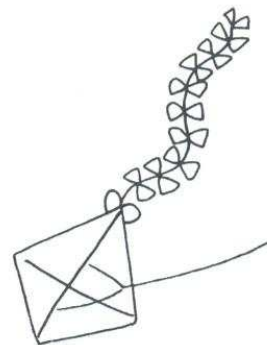

kite

32

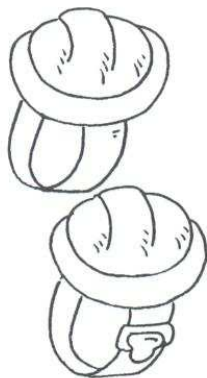

knee pads

32



play basketball

32

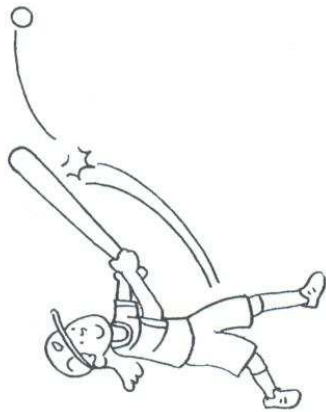

play baseball

32

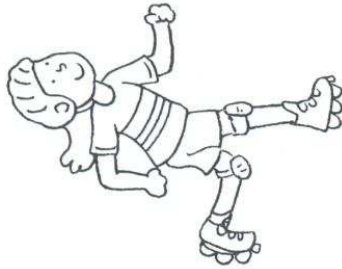

go skating

32



ride a bike

32

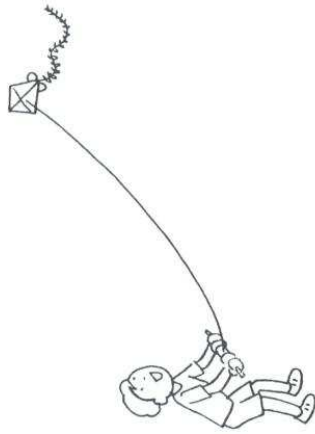

fly a kite

32



read comic books

32

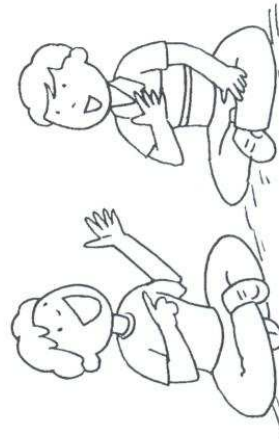

talk with friends

33



lion

33

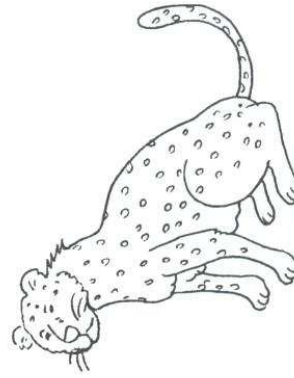

cheetah

33

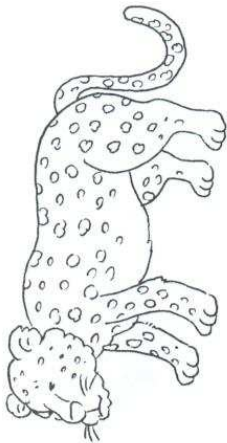

leopard

33



hyena

33

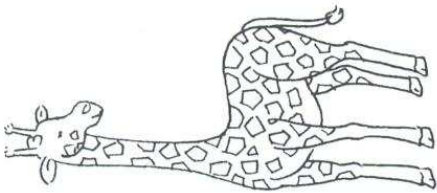

giraffe

33

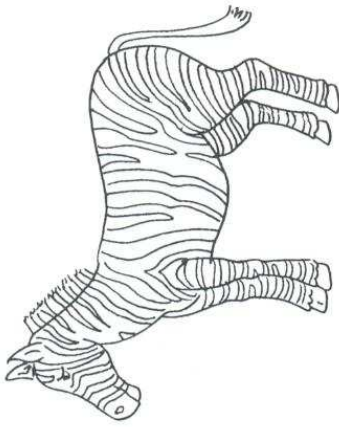

zebra

33

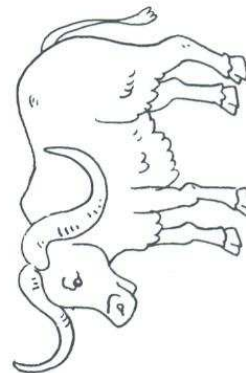

buffalo

33

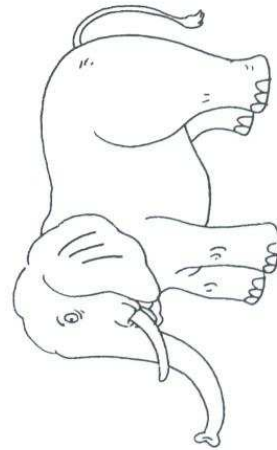

elephant

33



hippopotamus

33

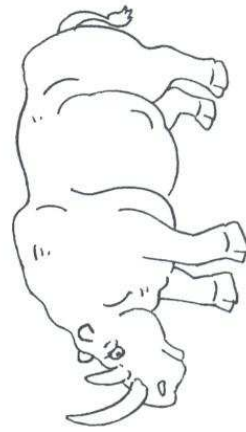

rhinoceros

33

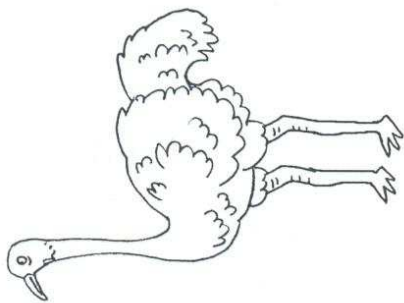

ostrich

33

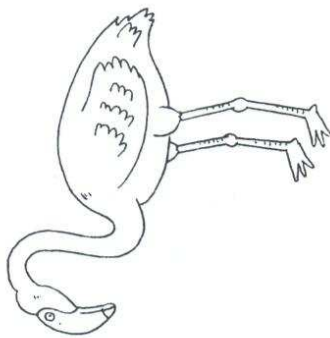

flamingo

33

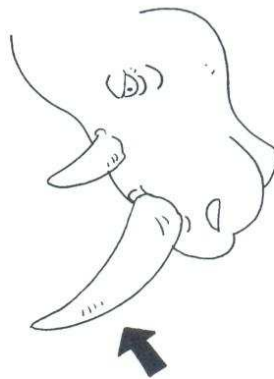

horn

33

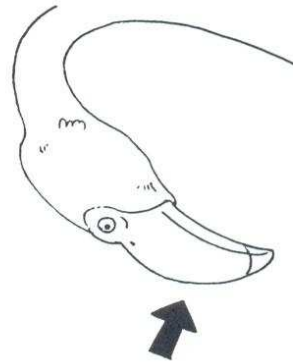

beak

33

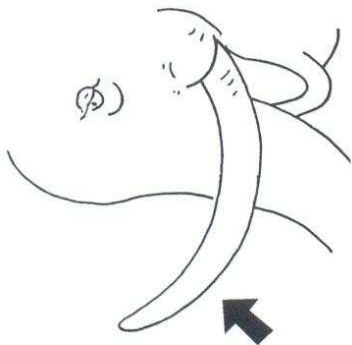

tusk

33

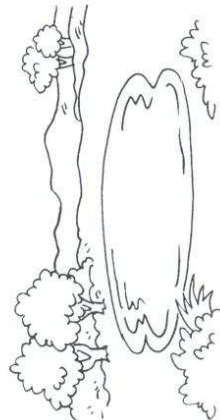

water hole

33

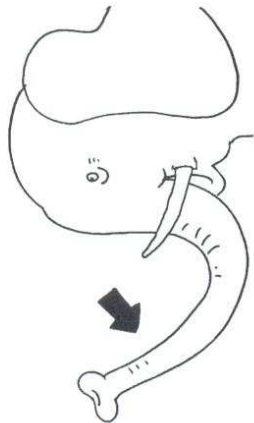

trunk

33

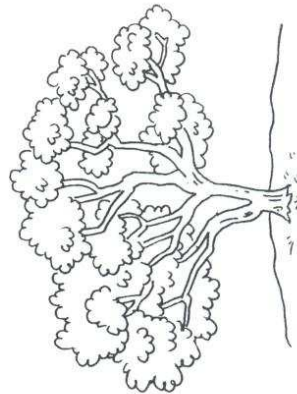

acacia tree

33

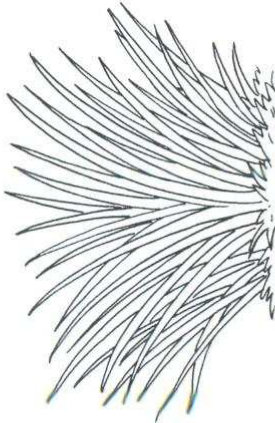

tall grass

33

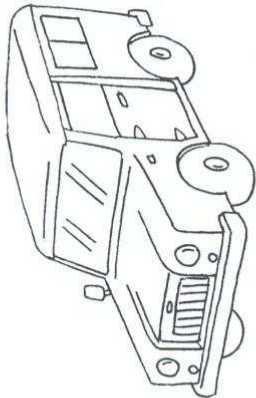

jeep

34

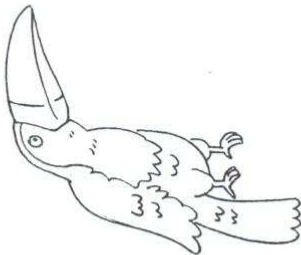

toucan

34

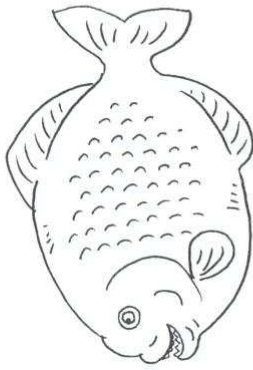

piranha

34

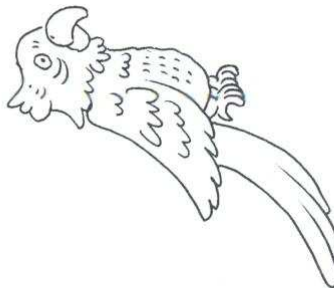

parrot

34



jaguar

34

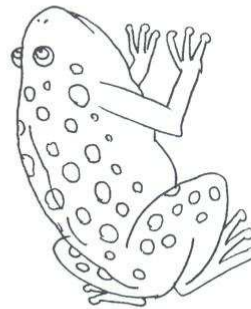

frog

34



tarantula

34

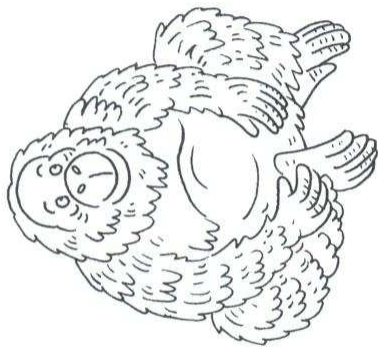

orangutang

34

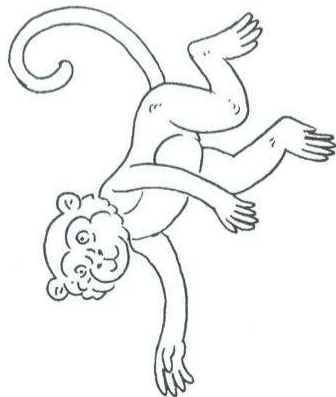

monkey

34

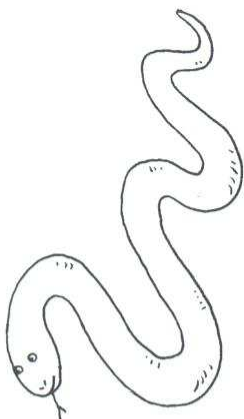

snake

34

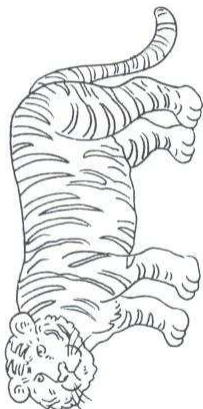

tiger

34

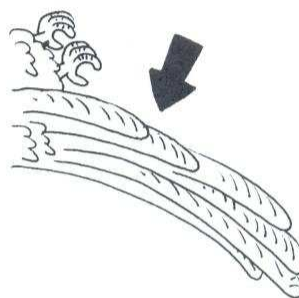

feathers

34

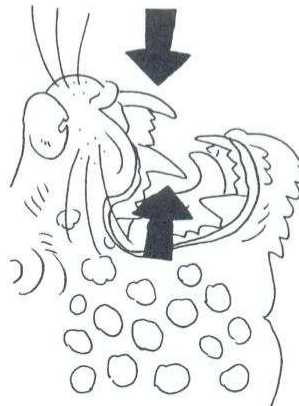

fangs

34

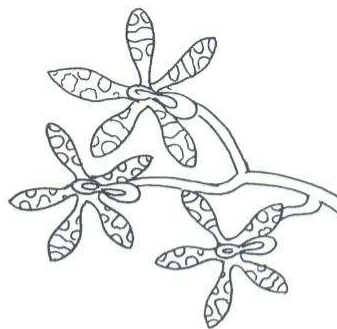

orchid

34

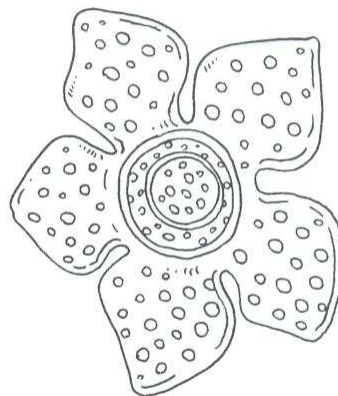

rafflesia

34

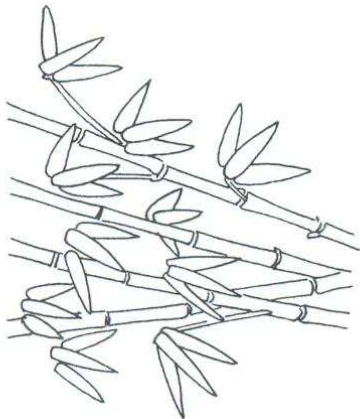

bamboo

34

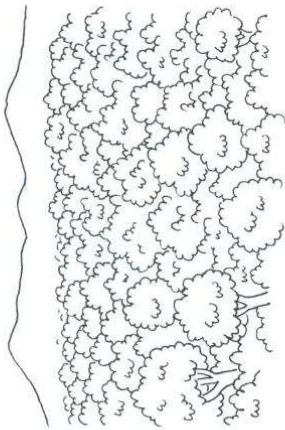

canopy

34

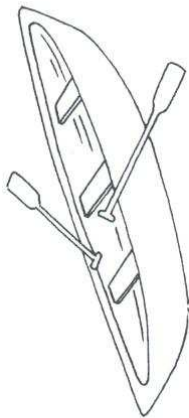

canoe

35

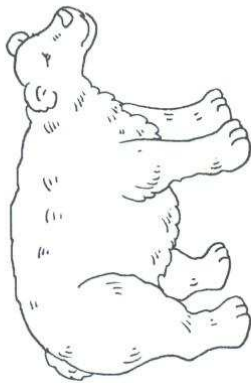

polar bear

35

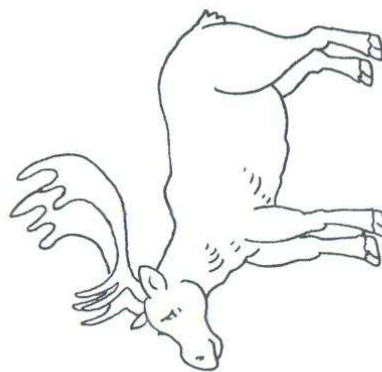

moose

35

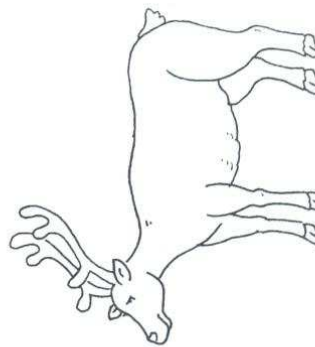

reindeer

35

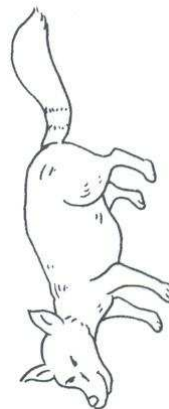

arctic fox

35



walrus



35

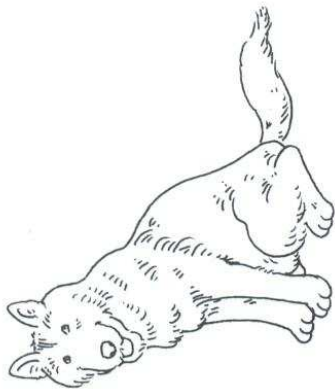

husky

35



blue whale

35

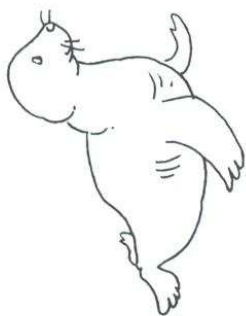

seal

35

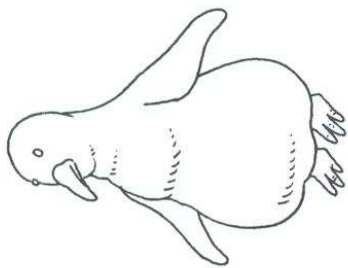

penguin

35

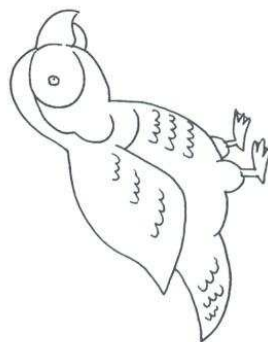

puffin

35

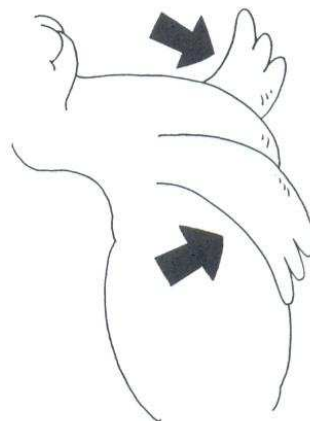

flippers

35

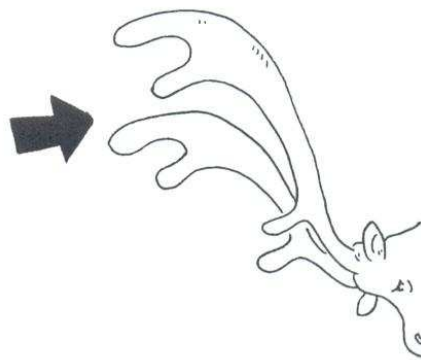

antlers

35

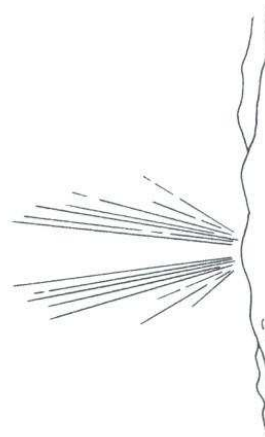

Northern Lights

35



iceberg

35

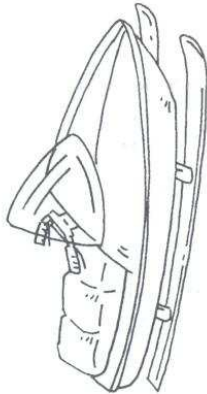

skidoo

36

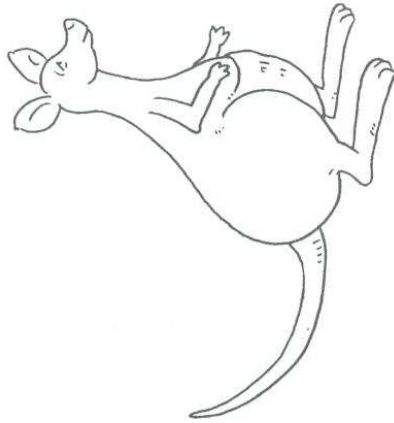

kangaroo

36

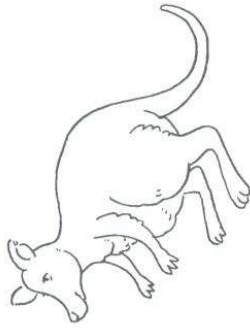

joey

36



koala

36



wombat

36



dingo

36



platypus

36

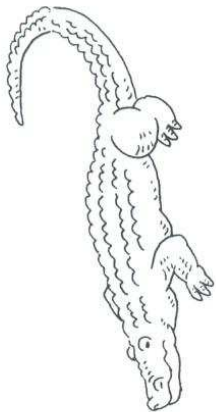

crocodile

36

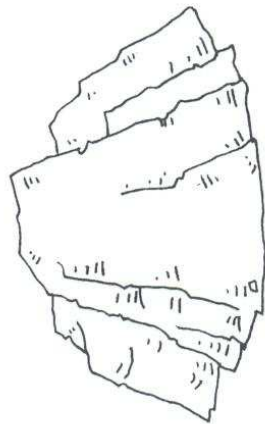

rock

36

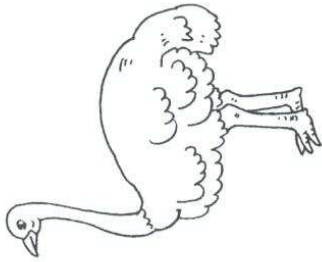

emu

36

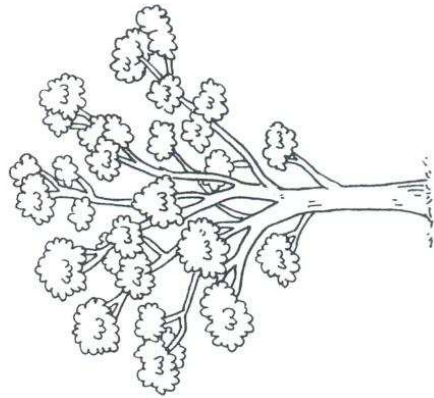

gum tree

36

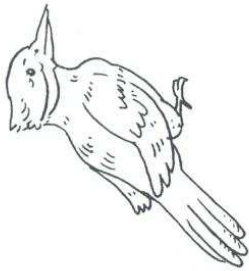

kookaburra

36

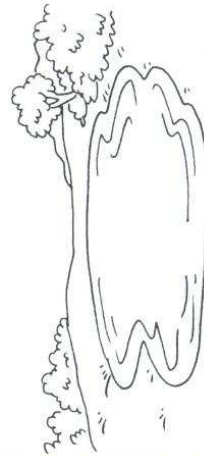

billabong

36

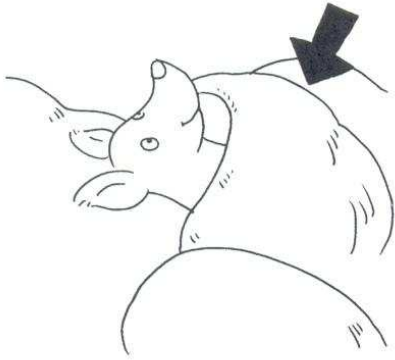

pouch

36

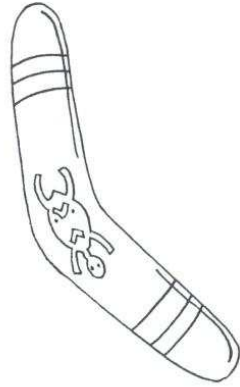

boomerang

36



didgeridoo

37

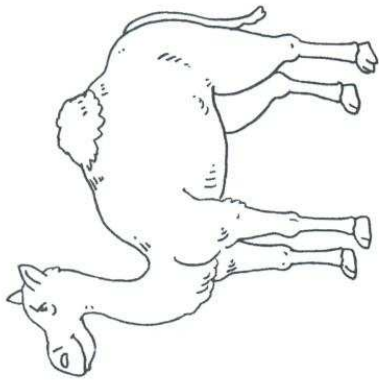

camel

37



vulture

37

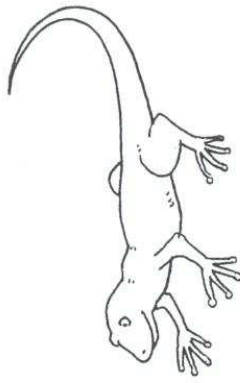

lizard

37

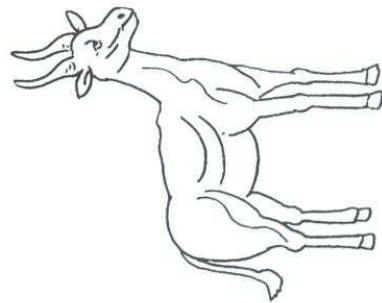

gazelle

37



eagle

37

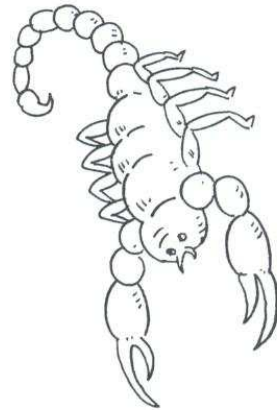

scorpion

37

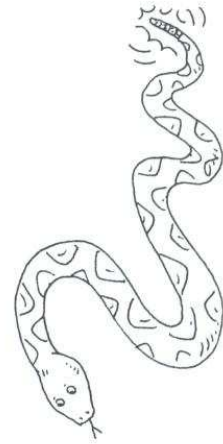

rattlesnake

37

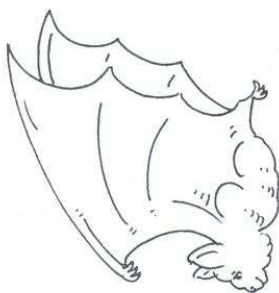

bat

37

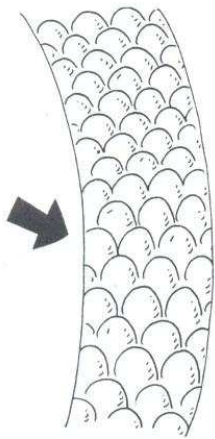

scales

37

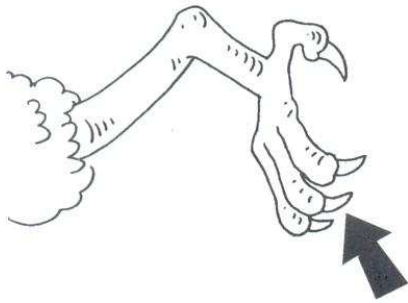

claws

37

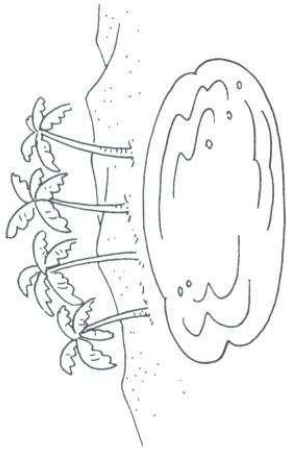

oasis

37



sand dune

37

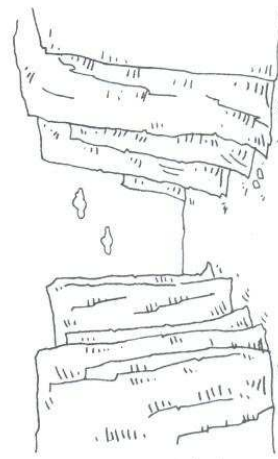

canyon

37

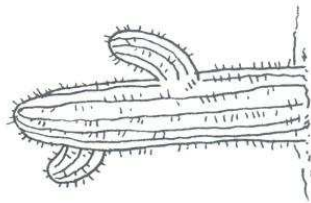

cactus

38

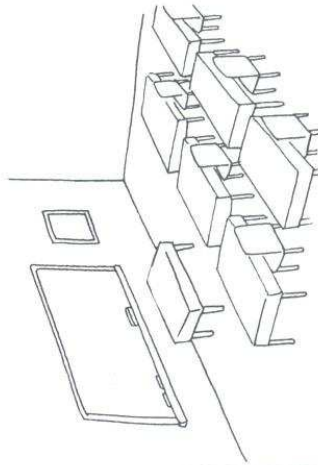

classroom

38

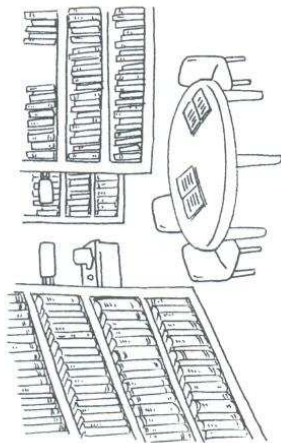

library

38

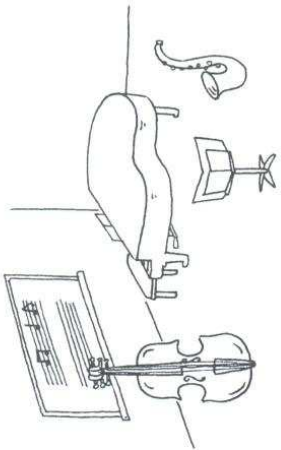

music room

38

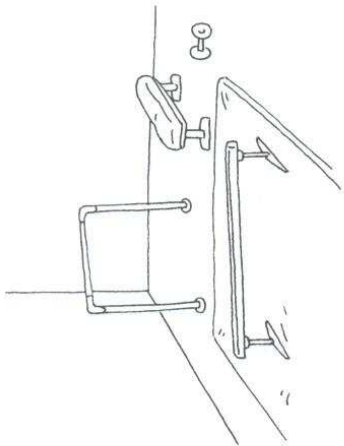

gym

38

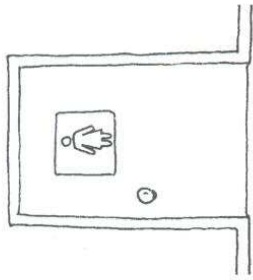

restroom

38

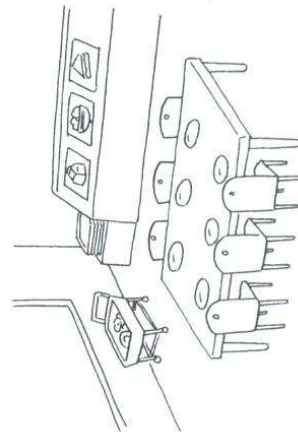

lunchroom

38

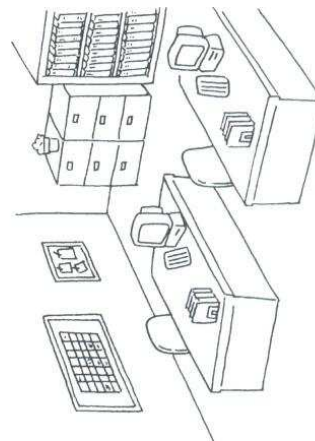

office

38

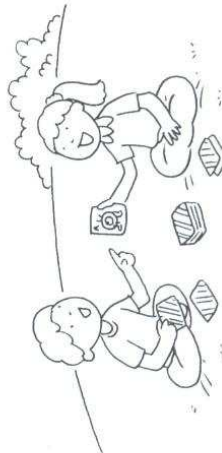

play cards

38



play soccer

38

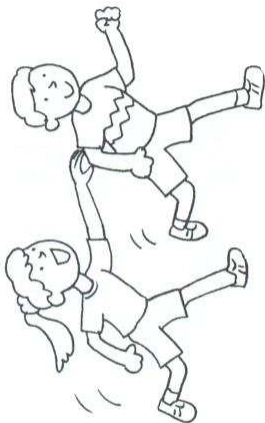

play tag

school bus

38



play hide and seek

science class

38

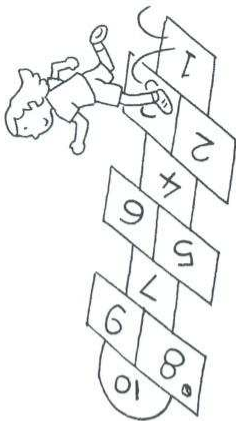

play hopscotch

music class

38



jump rope

art class

38

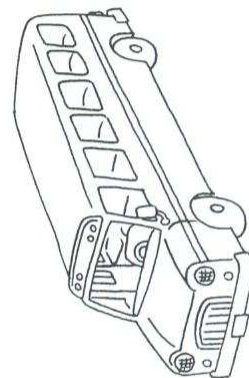

39

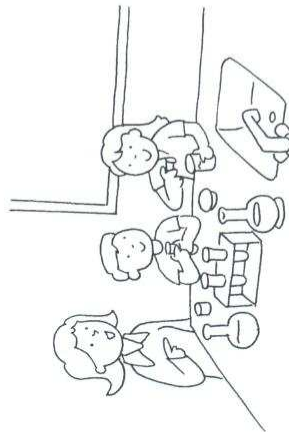

39



39

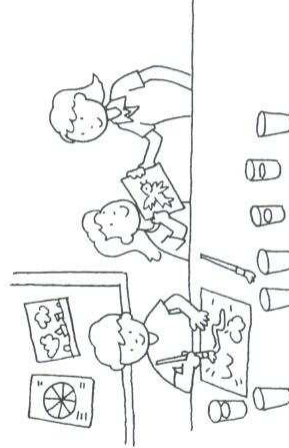

39

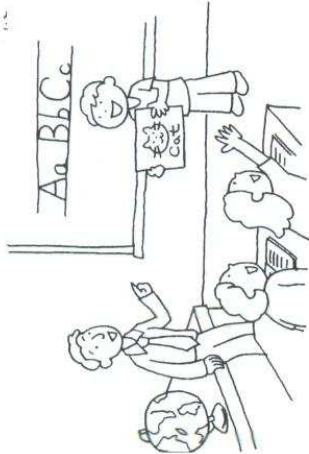

English class

whiteboard

39

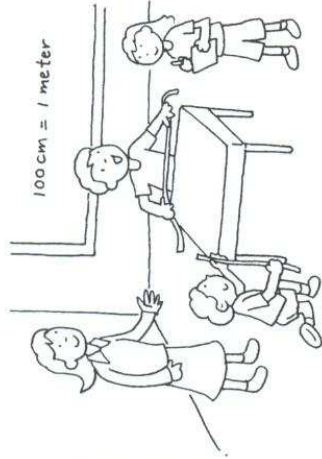

math class

desk

39

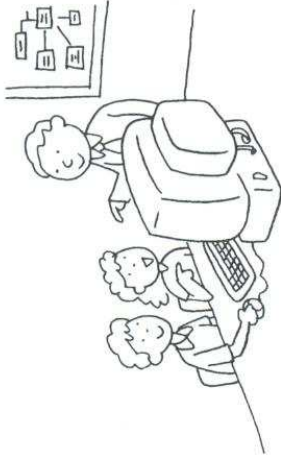

computer class

chair

39

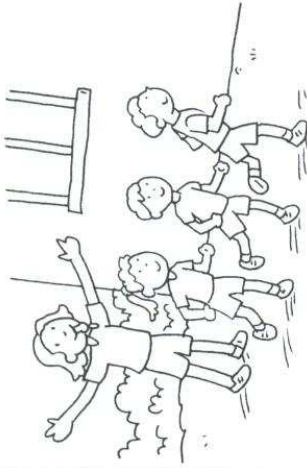

P.E.

poster

39

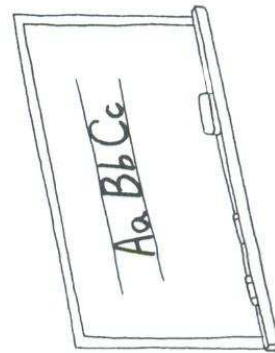

39

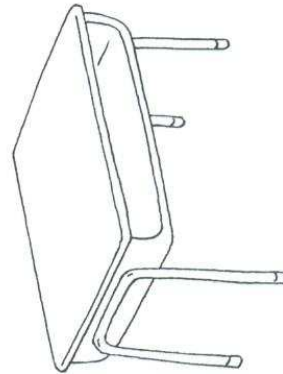

39

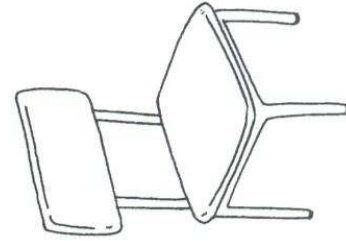

39

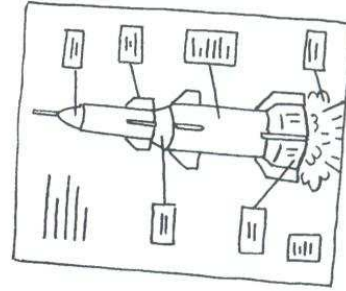



39

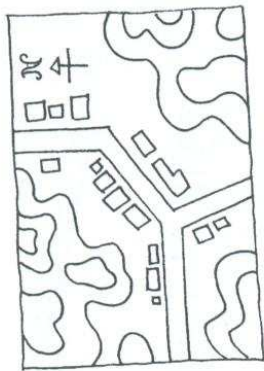

map

39



globe

39

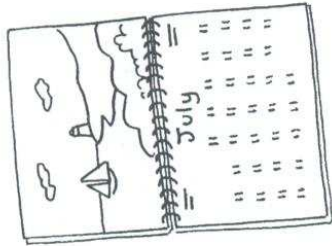

calendar

39



student

39

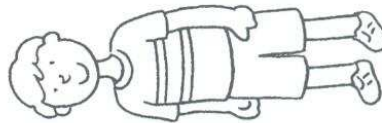

boy

39

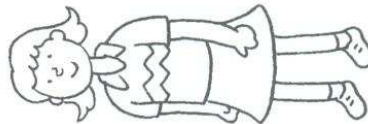

girl

40

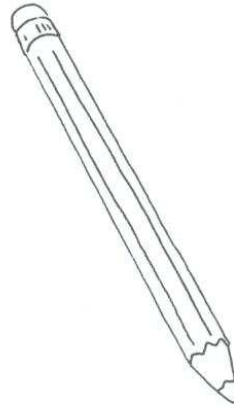

pencil

40

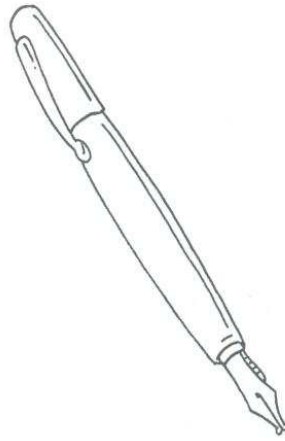

pen

40



notebook

40

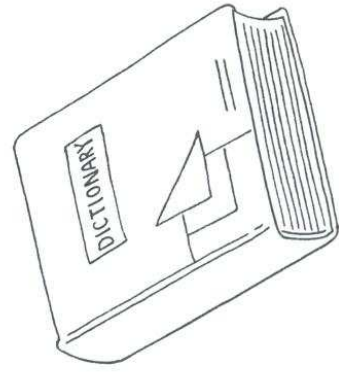

dictionary

40

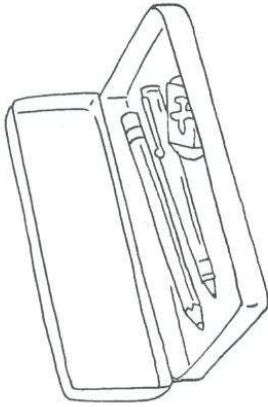

pencil case

40

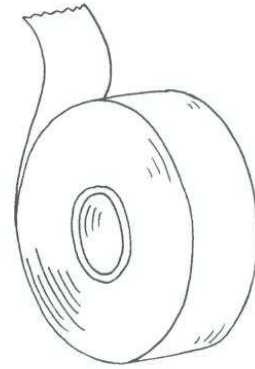

tape

40

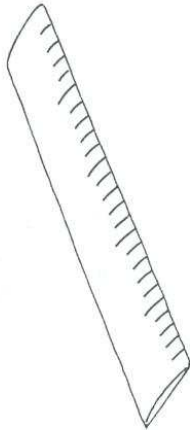

ruler

40

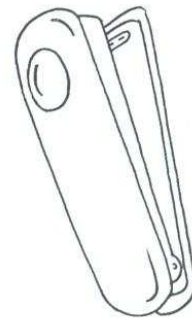

stapler

40

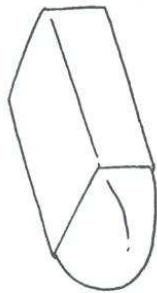

eraser

40

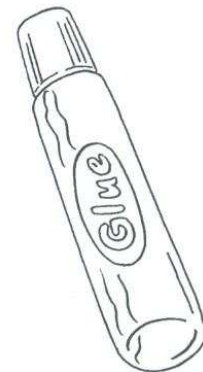

glue

40

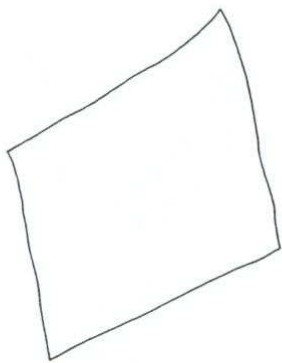

paper

40

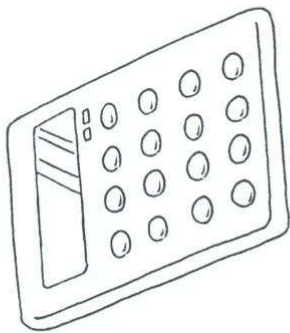

calculator

40

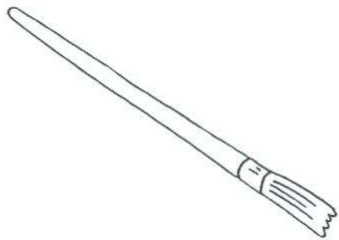

paintbrush

40

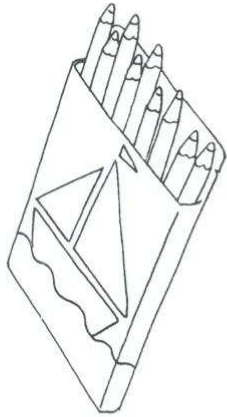

colored pencils

40

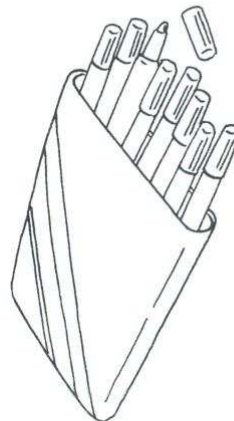

markers

40

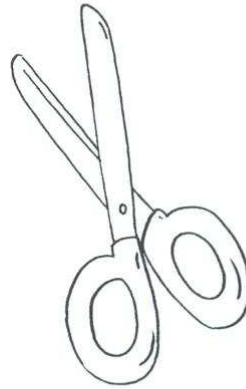

scissors

40

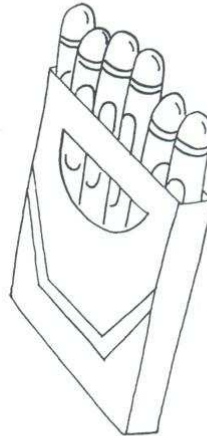

crayons

40

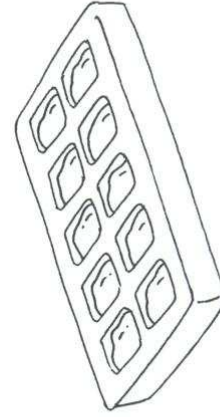

paints

40

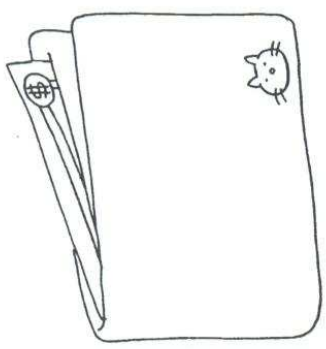

wallet

40

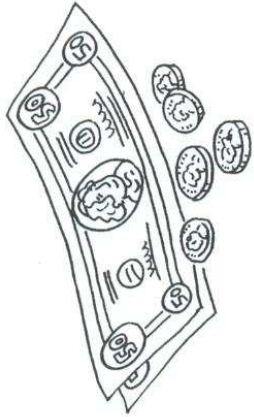

money

41

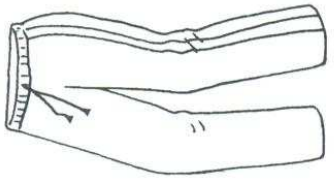

jogging pants

41

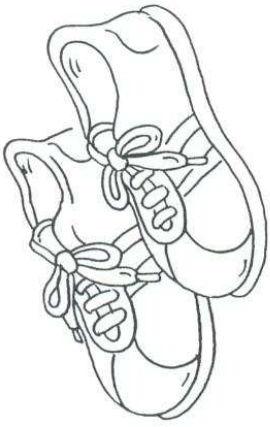

sneakers

41

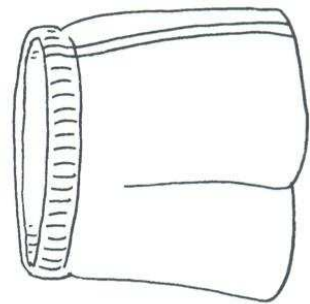

shorts

41

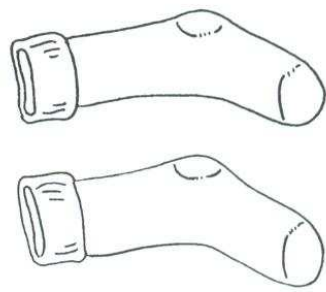

socks

41

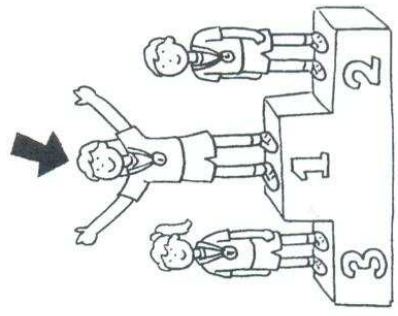

first

41

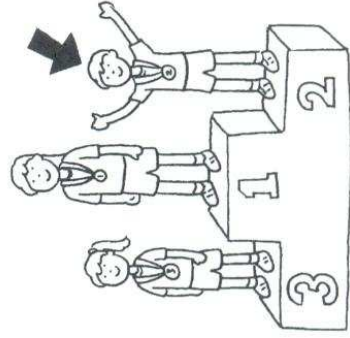

second

41

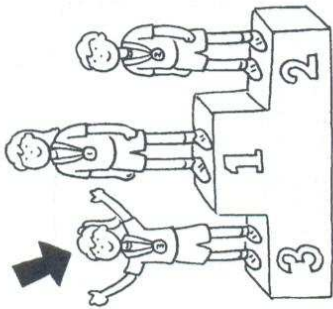

third

41

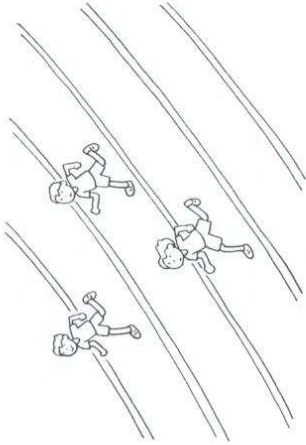

running a race

41

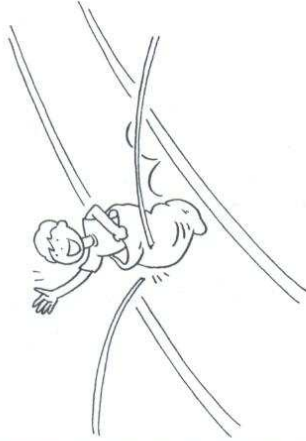

winning the sack race

41



kicking a ball

41



throwing a beanbag

41

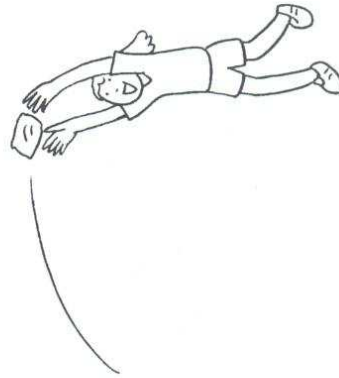

catching a beanbag

41

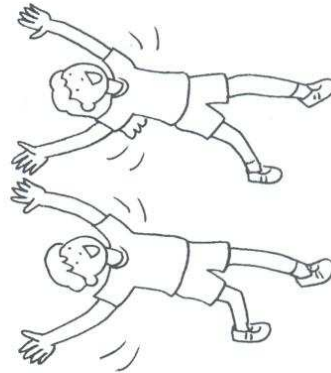

cheering

41

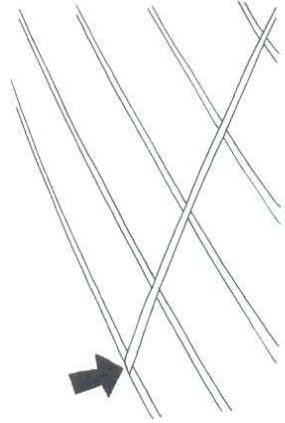

starting line

41

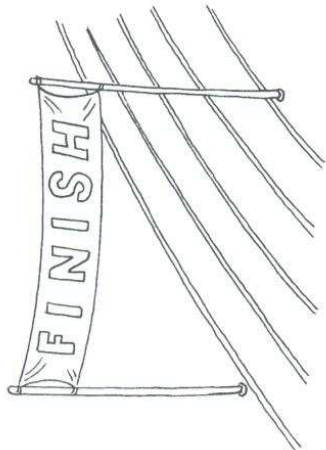

finish line

41

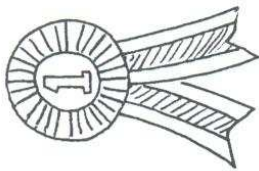

ribbon

42

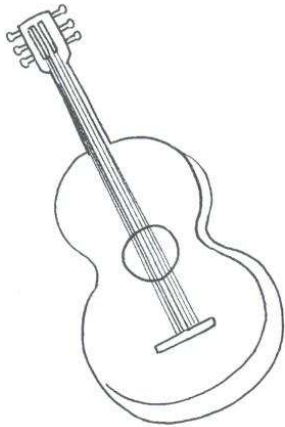

guitar

42

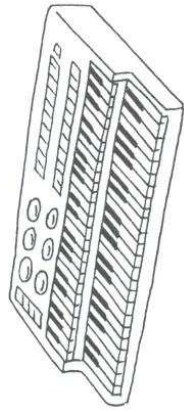

keyboard

42

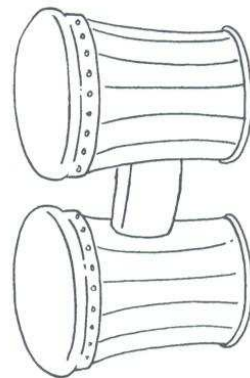

bongo drums

42

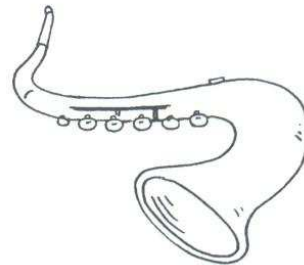

saxophone

42



piano

42

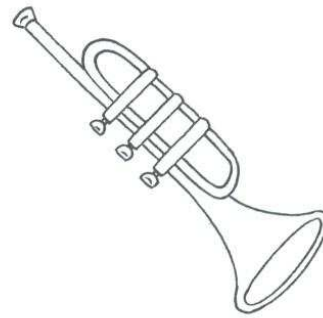

trumpet

42

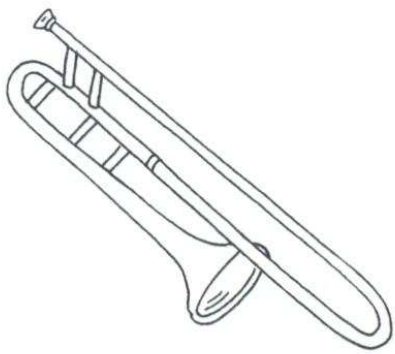

trombone

42



violin

42



flute

42

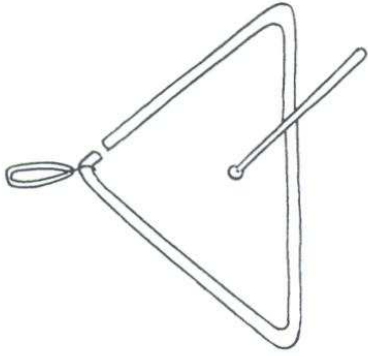

triangle

42

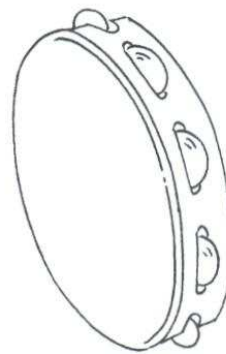

tambourine

42

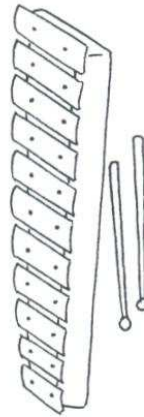

xylophone

42

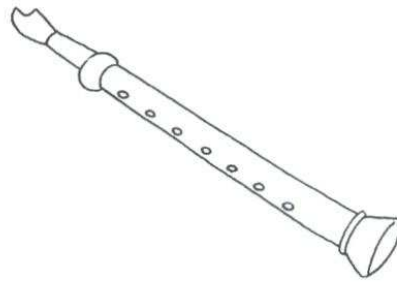

recorder

42

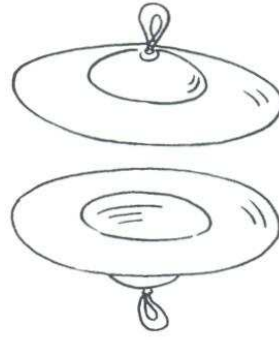

cymbals

42

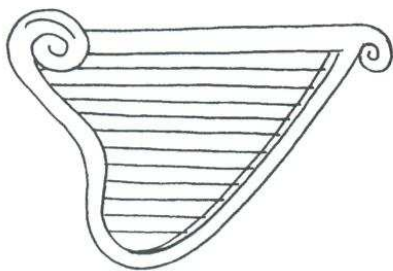

harp

43

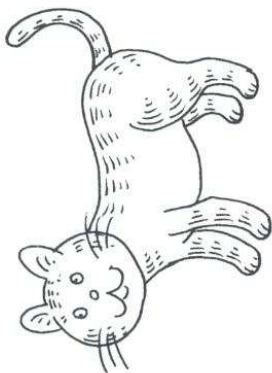

cat

43

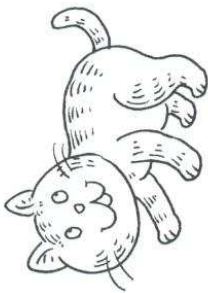

kitten

43

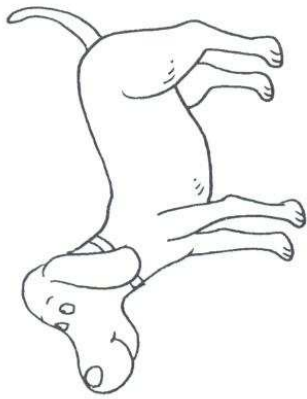

dog

43

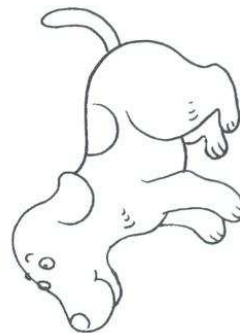

puppy

43

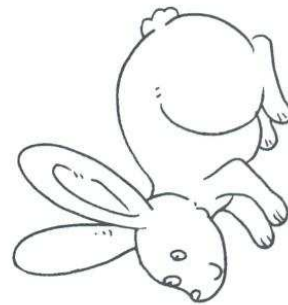

rabbit

43



guinea pig

43



hamster



43



goldfish

43

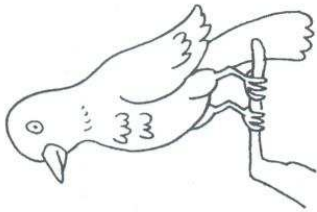

bird

43

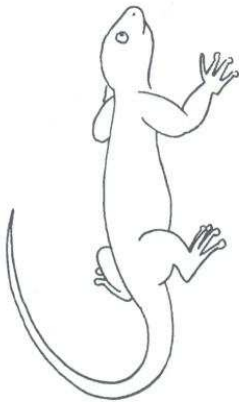

gecko

43

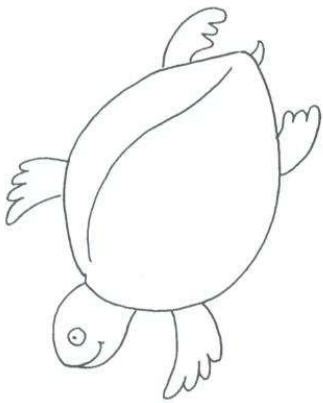

turtle

43

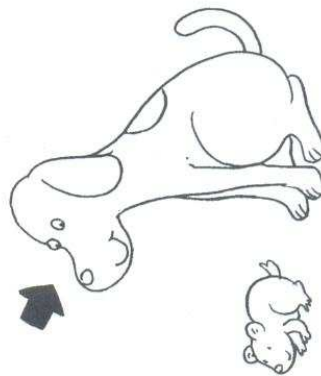

big

43

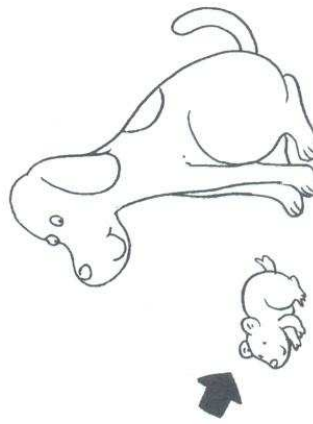

small

43



fast

43



slow

43

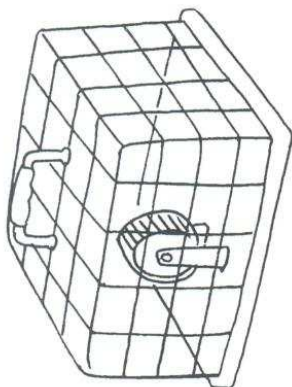

cage

44

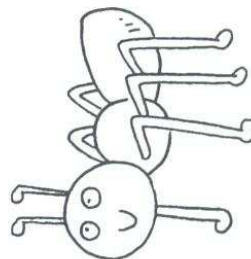

ant

43

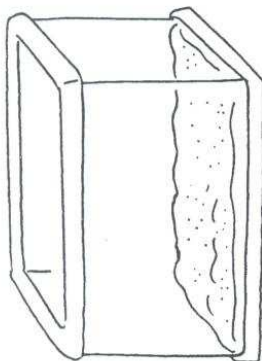

tank

44

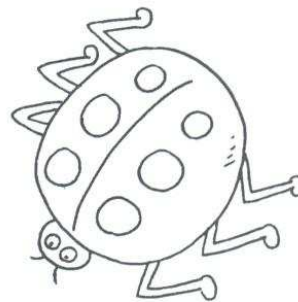

ladybug

43

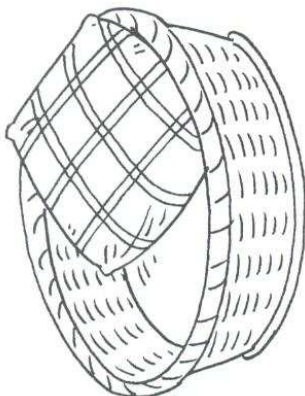

basket

44



bee

44



spider

44

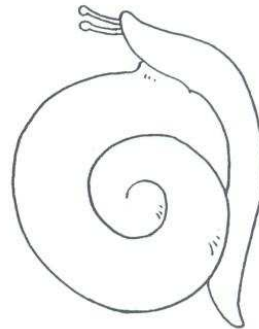

snail

44

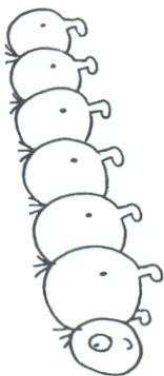

caterpillar

44

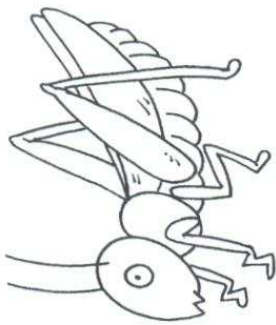

grasshopper

44

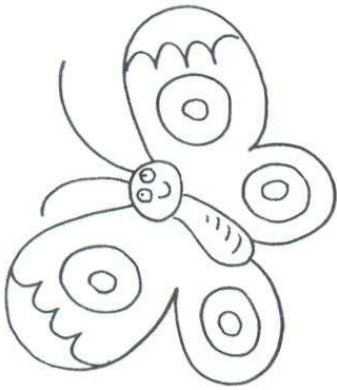

butterfly

44

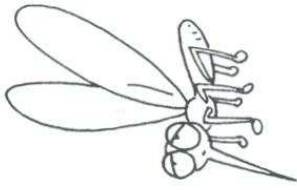

mosquito

44

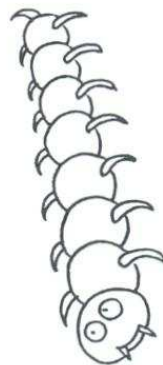

centipede

44



worm

44

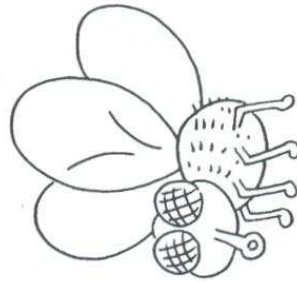

fly

44

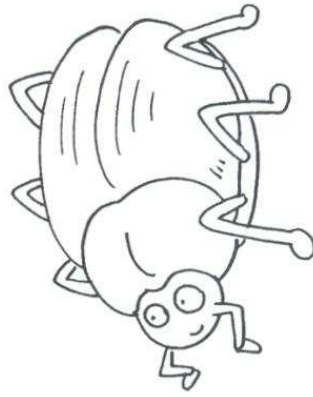

beetle

44

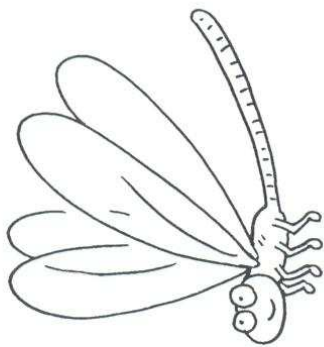

dragonfly

44

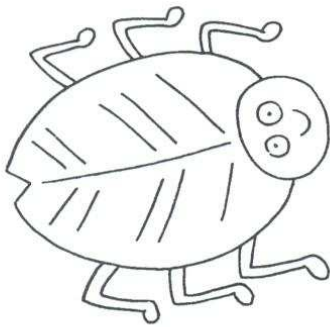

cicada

44



web

45

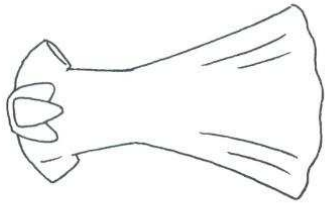

dress

45

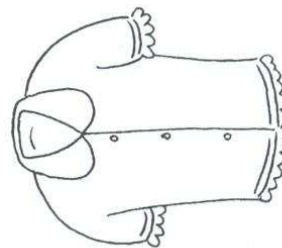

blouse

45

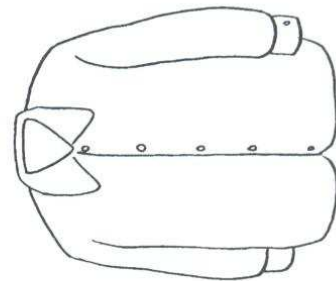

shirt

45

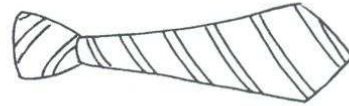

tie

45



gloves

45

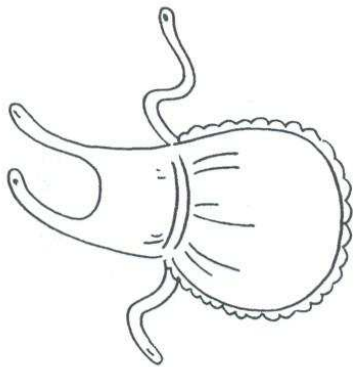

apron

45



necklace

45

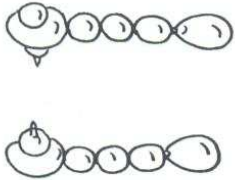

earrings

45

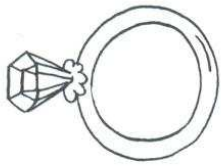

ring

45

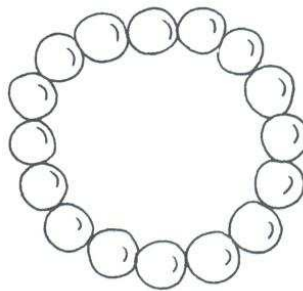

bracelet

45



glasses

45

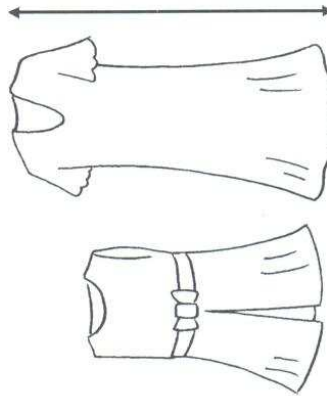

long

45

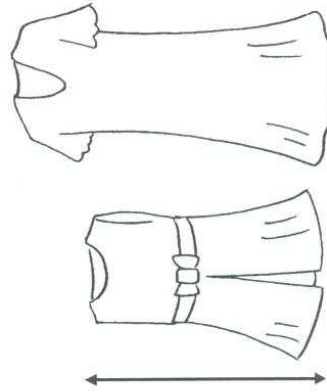

short

45

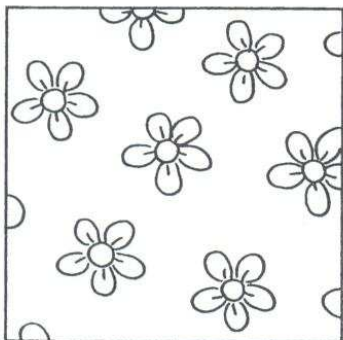

flowered

45

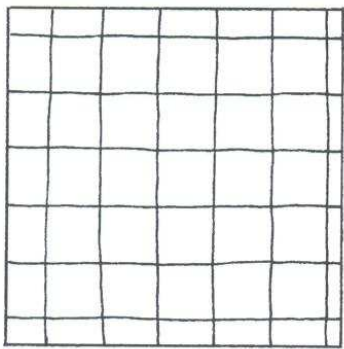

checked

45

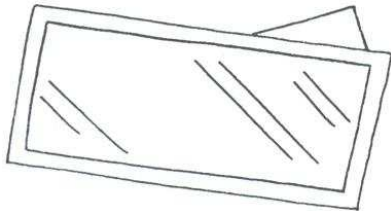

mirror

46

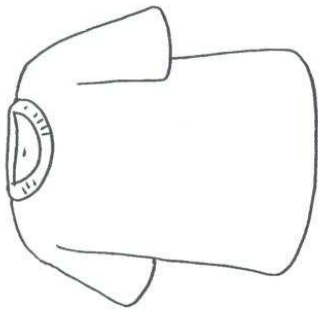

T-shirt

46

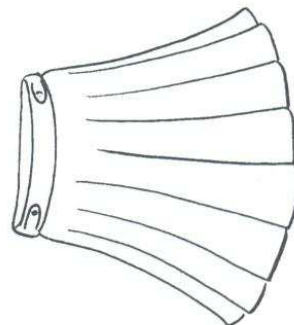

skirt

46

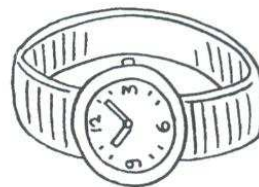

watch

46



sandals

46

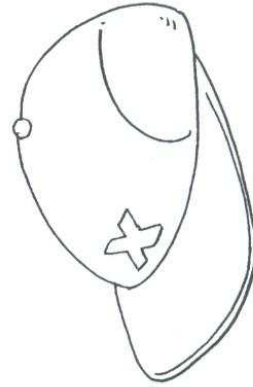

cap

46

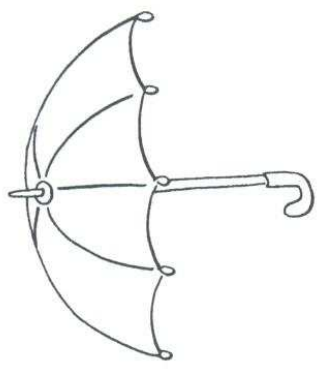

umbrella

46



belt

46

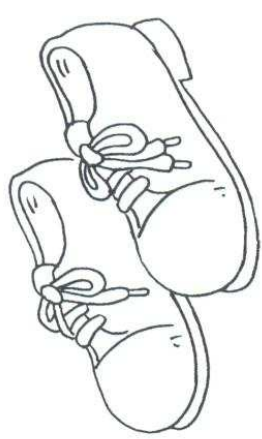

shoes

46

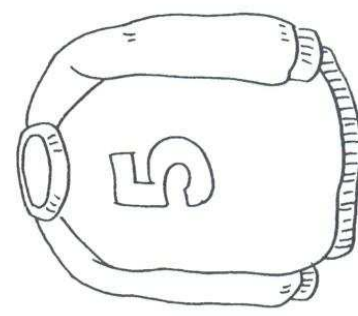

sweatshirt

46

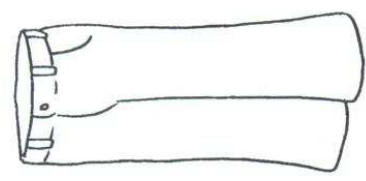

pants

46

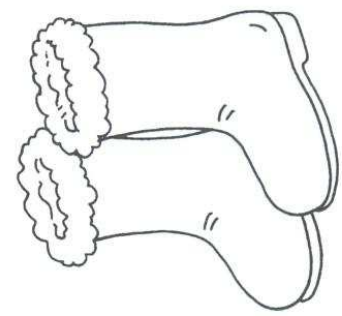

boots

46

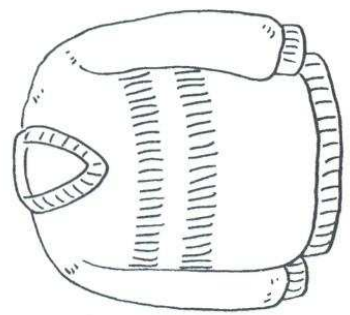

sweater

46

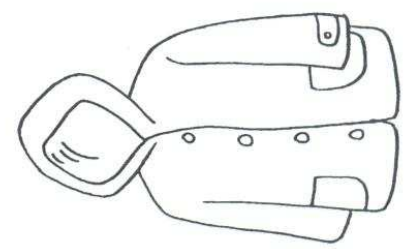

raincoat

46

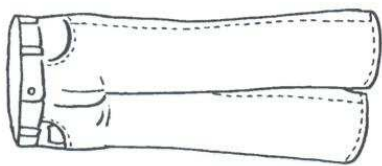

jeans

46

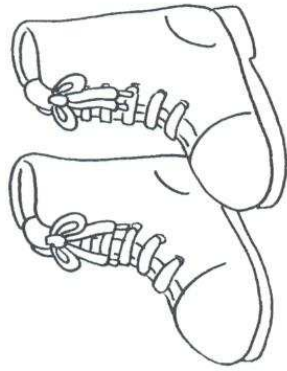

hiking boots

46

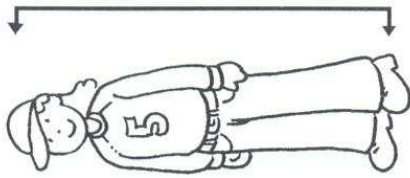

outfit

47

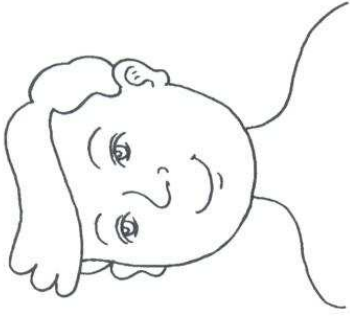

head

47

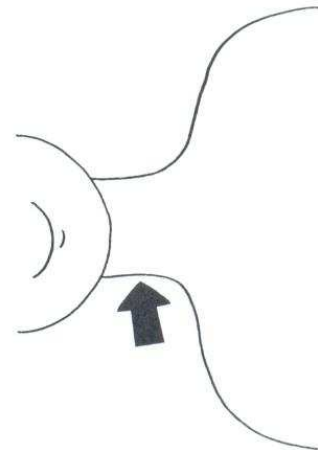

neck

47

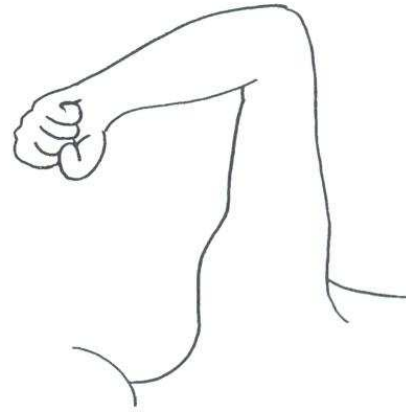

arm

47



elbow

47

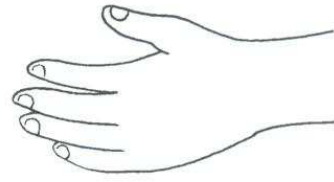

hand



47

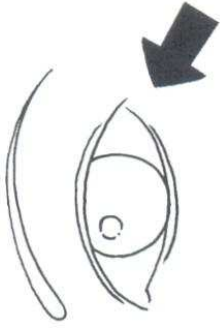

eye

47

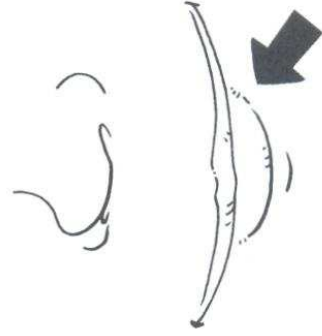

mouth

47

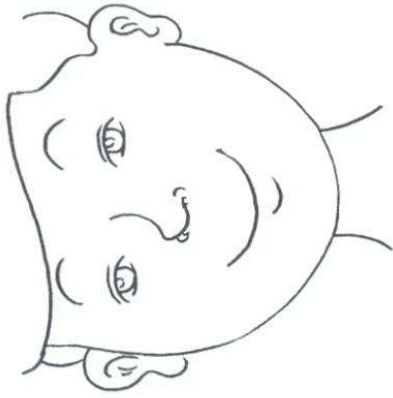

face

47

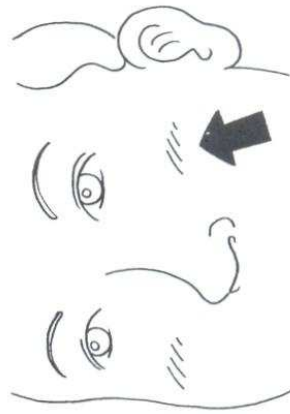

cheek

47

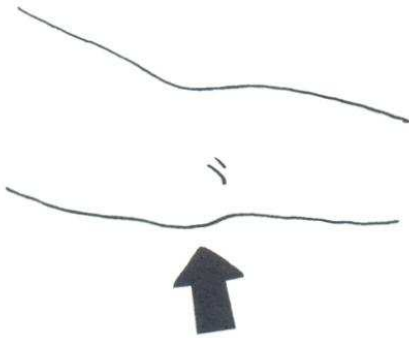

knee

47

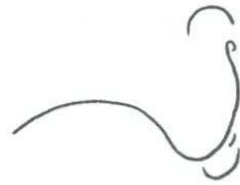

nose

47

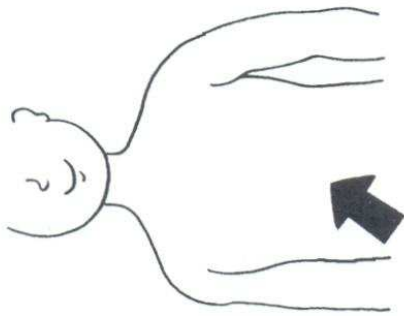

stomach

47



ear

47

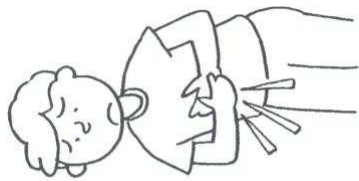

have a stomachache

47



have a cough

47



have a cold

47



have a headache

48

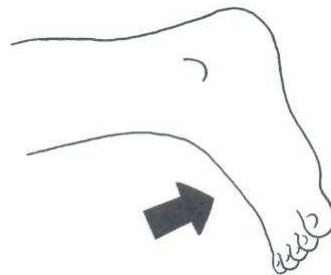

foot

48

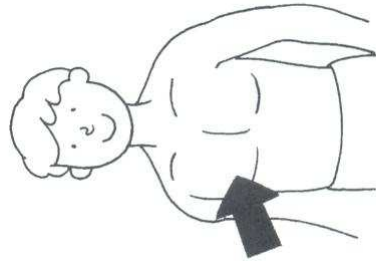

chest

48

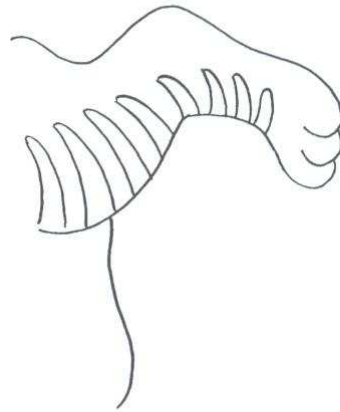

leg

48

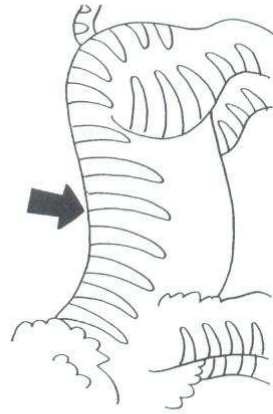

back

48

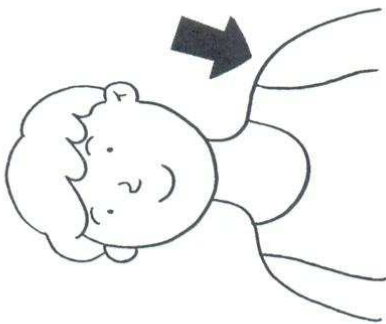

shoulder

48

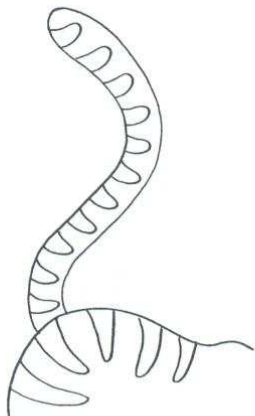

tail

48

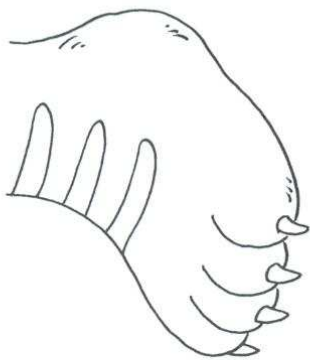

paw

48



tongue

48

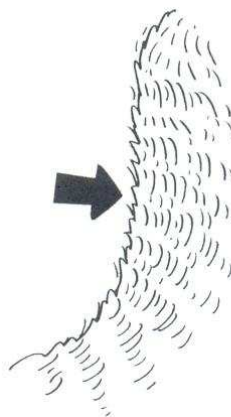

fur

48

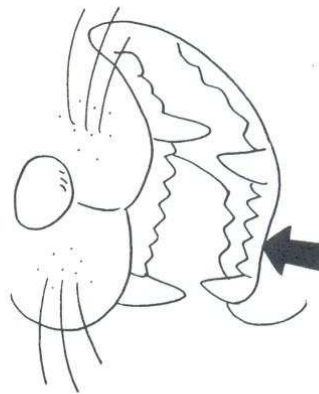

teeth

48

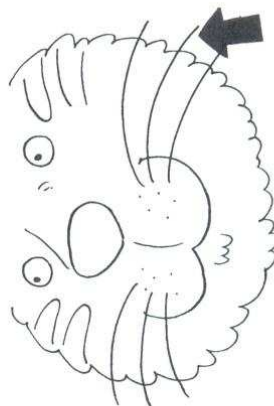

whiskers

48

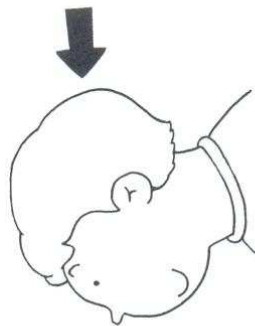

hair

48



toes

48



fingers

48

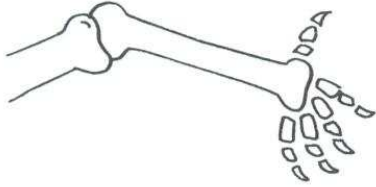

bones

48

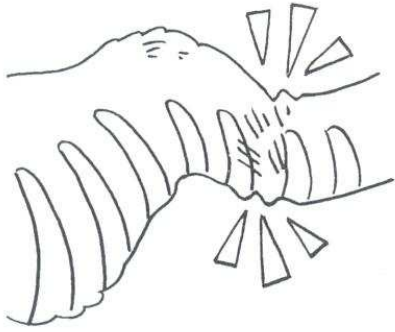

broken leg

48

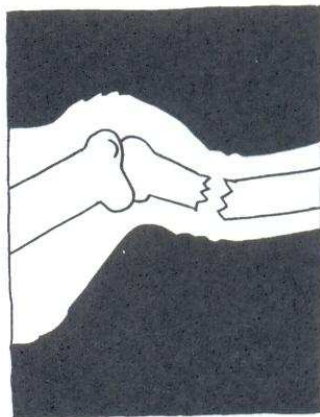

x-ray

49

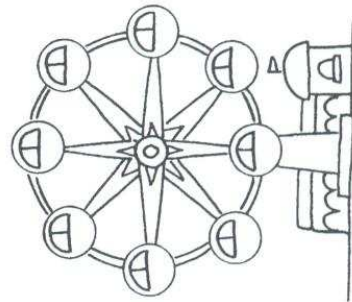

ferris wheel

49

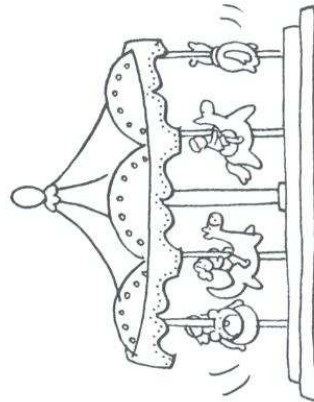

merry-go-round

49

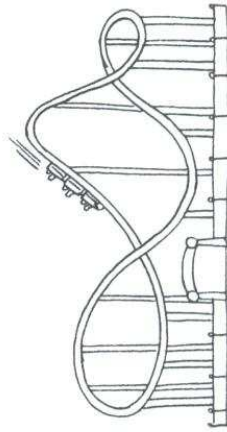

roller coaster

49

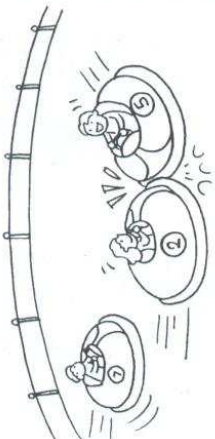

bumper cars

49

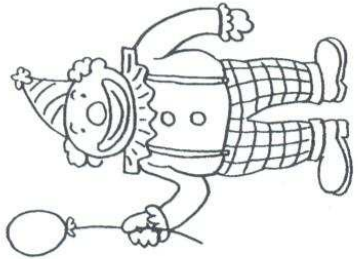

clown

49

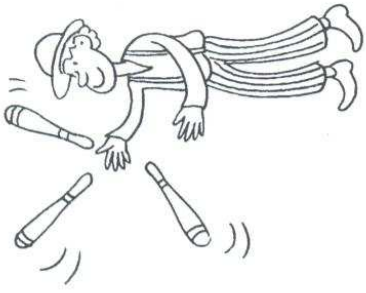

juggler

49

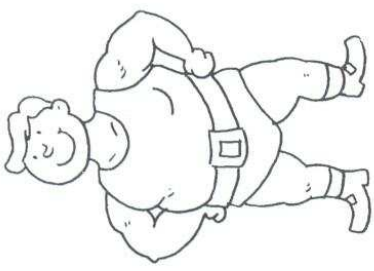

strongman

49



acrobat

49

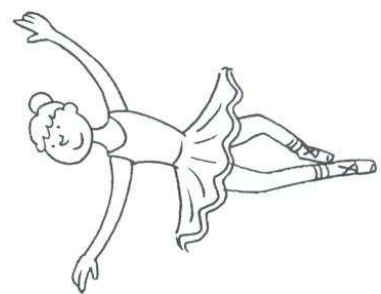

dancer

49

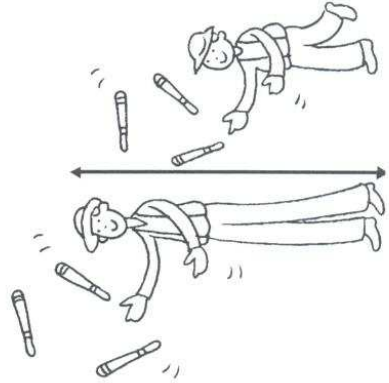

tall

49

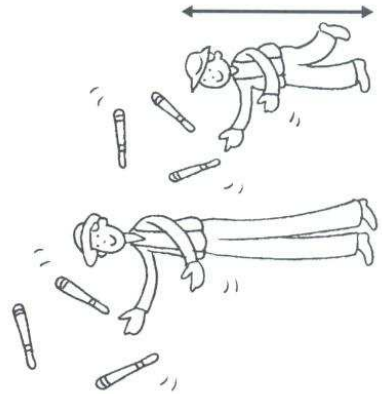

short

49

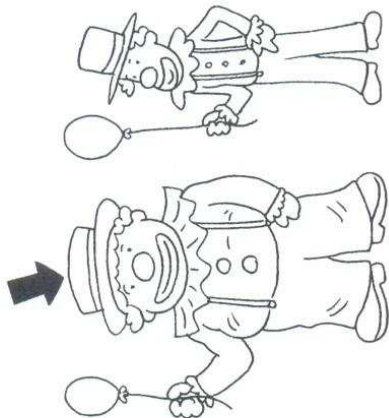

large

49

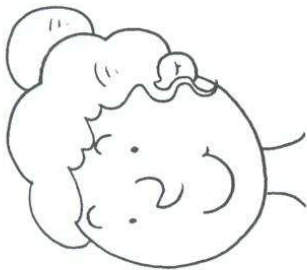

beautiful

49

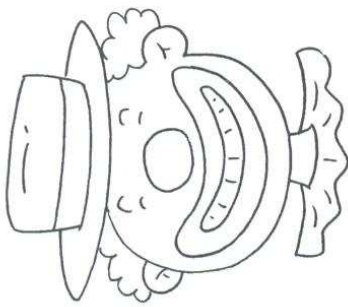

happy

49

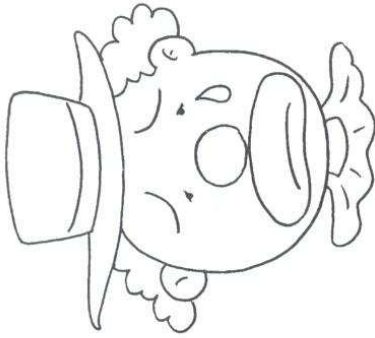

sad

49



wet

49

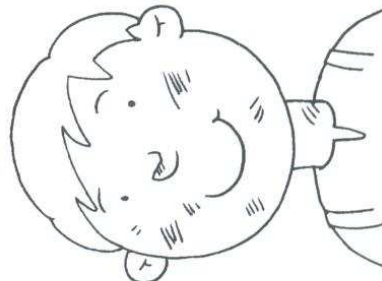

dirty

49

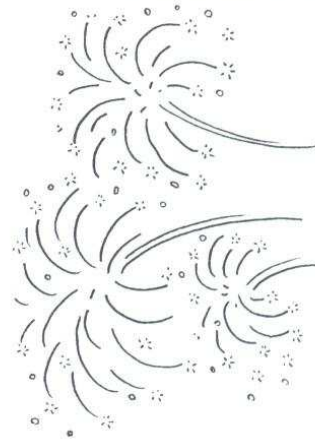

fireworks

50

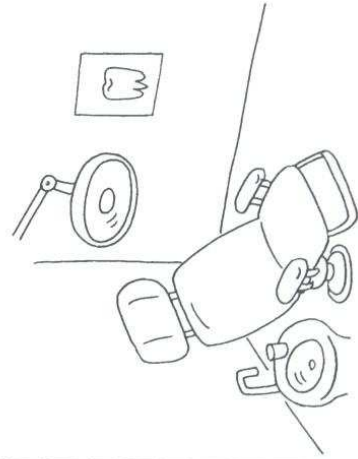

dentist's office

50

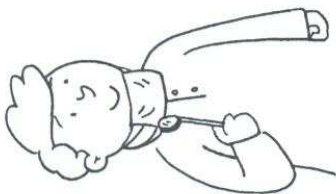

dentist

50

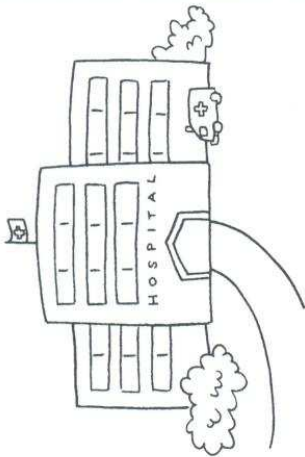

hospital

50

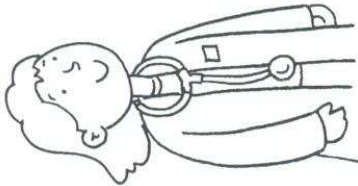

doctor

50

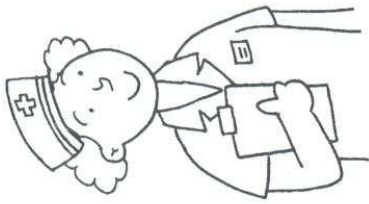

nurse

50

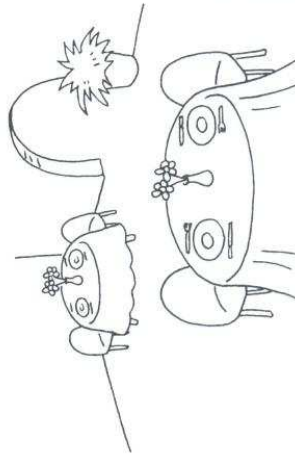

restaurant

50

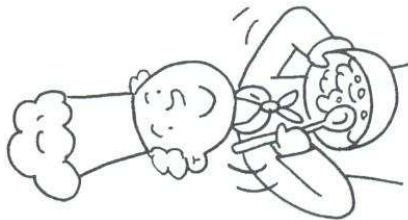

cook

50

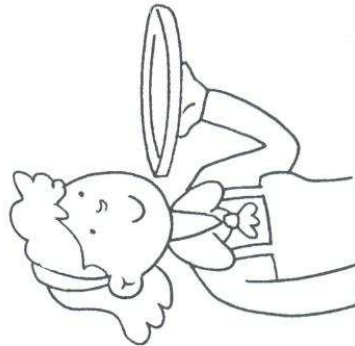

waitress

50



waiter

50

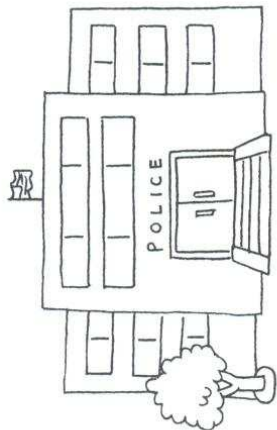

police station

50

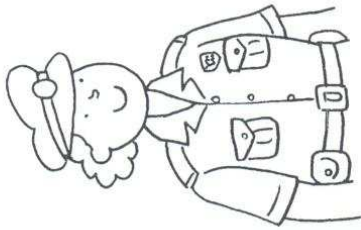

police officer

50

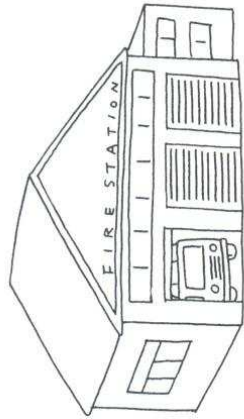

fire station

50

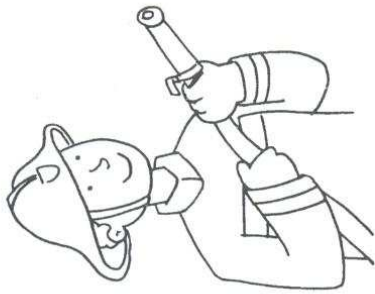

firefighter

50

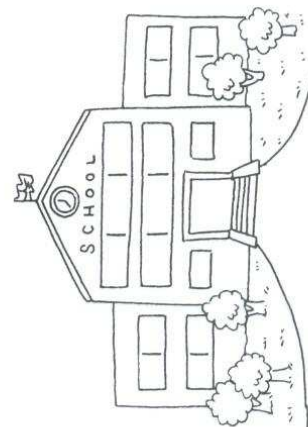

school

50

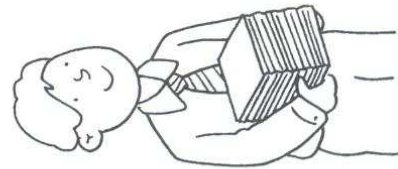

teacher

50

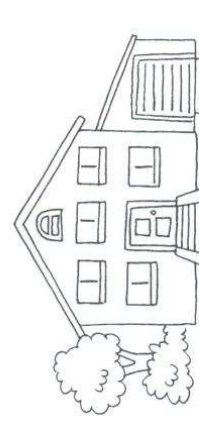

house

50

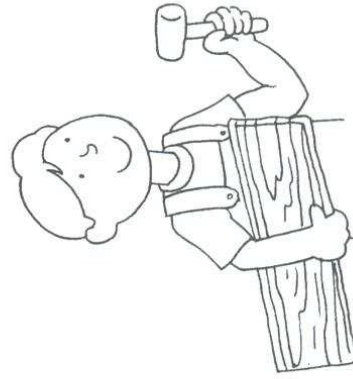

carpenter



50

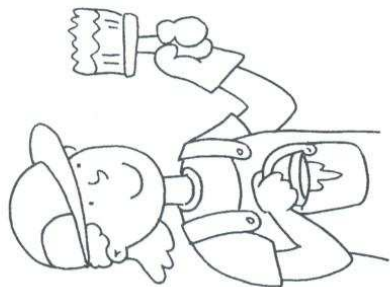

painter

50



post office

50

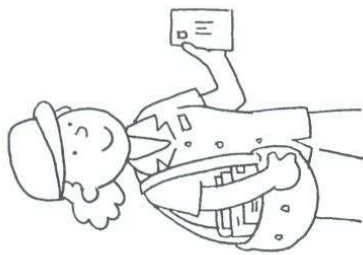

mail carrier

Longman Children's  
**Picture Dictionary**

**Teacher's Resource Book**

The **Longman Children's Picture Dictionary** presents 800 words in a variety of richly illustrated and photographed topics.

The **Teacher's Resource Book** provides a wide range of ideas and materials for practicing and reviewing vocabulary in the Picture Dictionary.

**Key features:**

- Over 850 photocopiable flashcards
- 27 photocopiable board games
- A selection of activity and game ideas
- Lesson notes for each dictionary topic

**This series includes:**

Picture Dictionary with two CDs  
Teacher's Resource Book  
Workbook 1  
Workbook 2  
[www.childrenspicturedictionary.com](http://www.childrenspicturedictionary.com)



**PEARSON**  
**Longman**

[pearsonlongman.com](http://pearsonlongman.com)

ISBN 978-962-00-5316-0



9 789620 053160