



# Vocabulary 3

# Vocabulary 3

*Test Your Vocabulary 3* is the third in a series of five best-selling *Test Your Vocabulary* books. This fully revised and updated edition features 60 varied and enjoyable vocabulary tests covering the most important words and phrases needed by intermediate-level students.

- 60 tests for practising essential vocabulary at intermediate level
- Wide variety of tests, including crosswords, cartoons, fill-the-gaps, and many more
- Tips on learning vocabulary
- A-Z word list and full answer key
- Ideal for self-study and classroom use

Cover designed by Ten Toes Design

Cover photograph supplied by Telegraph Colour Library

Also look out for:



<input type="checkbox"/>	Advanced	<input type="checkbox"/>	Adults
<input type="checkbox"/>	Upper Intermediate	<input type="checkbox"/>	16+
<input type="checkbox"/>	Intermediate	<input type="checkbox"/>	12-15
<input type="checkbox"/>	Pre-intermediate	<input type="checkbox"/>	Primary
<input type="checkbox"/>	Elementary	<input type="checkbox"/>	
<input type="checkbox"/>	Beginner	<input type="checkbox"/>	



Published and distributed by Pearson Education Limited

ISBN 0-582-45168-X



9 780582 451681

Peter Watcyn-Jones and Olivia Johnston



# Test Your Vocabulary 3

Peter Watcyn-Jones  
and Olivia Johnston



PENGUIN ENGLISH

**Pearson Education Limited**

Edinburgh Gate  
Harlow  
Essex CM20 2JE, England  
and Associated Companies throughout the world.

ISBN 0 582 45168 X

Fourth impression 2005

First published in Sweden by Kursverksamhetens förlag 1982

Published by Penguin Books, 1985, 1996

This edition published 2002

Text copyright © Peter Watcyn-Jones 1985, 1996, 2002

Text copyright © Olivia Johnston 2002

Designed and typeset by Pantek Arts Ltd, Maidstone, Kent

Test Your format devised by Peter Watcyn-Jones

Illustrations by David Ashby, Rupert Besley, Martin Fish and Vince Siccock

Printed in China SWTC/04

*All rights reserved; no part of this publication may be reproduced, stored in a retrieval system, or transmitted in any form or by any means, electronic, mechanical, photocopying, recording or otherwise, without the prior written permission of the Publishers.*

Published by Pearson Education Limited in association with Penguin Books Ltd, both companies being subsidiaries of Pearson plc.

For a complete list of the titles available from Penguin English please visit our website at [www.penguinenglish.com](http://www.penguinenglish.com), or write to your local Pearson Education office or to: Marketing Department, Pearson Education, Edinburgh Gate, Harlow, Essex CM20 2JE.

# Contents

To the student	iv	<b>32</b> Filling in forms	57
<b>1</b> Things in the home	1	<b>33</b> Adjectives: things	58
<b>2</b> Adjectives: people 1	2	<b>34</b> Disasters	60
<b>3</b> Phrasal verbs 1	4	<b>35</b> Parts of a car	62
<b>4</b> The body	6	<b>36</b> Prepositions 1	64
<b>5</b> Food and drink 1	7	<b>37</b> Physical appearance	66
<b>6</b> The house and garden	8	<b>38</b> Verbs: mostly in the mind	68
<b>7</b> Adjectives: opposites	10	<b>39</b> British and American English	70
<b>8</b> Crime	12	<b>40</b> Cartoons 2	72
<b>9</b> Jobs	14	<b>41</b> Confusing words	74
<b>10</b> Food and drink 2	16	<b>42</b> Verbs: opposites	76
<b>11</b> Choose the word	18	<b>43</b> Prepositions 2	78
<b>12</b> Fruit and vegetables	20	<b>44</b> Types of transport	80
<b>13</b> Getting a job	22	<b>45</b> Adjectives: synonyms	82
<b>14</b> Verbs: communicating	24	<b>46</b> Phrasal verbs 2	84
<b>15</b> Verbs: body and mind	26	<b>47</b> Things to read	86
<b>16</b> Verbs: relationships	28	<b>48</b> Classifications	88
<b>17</b> Word building: prefixes	30	<b>49</b> Homophones	90
<b>18</b> Around the house	32	<b>50</b> Verbs: synonyms	92
<b>19</b> Adjectives: people 2	34	<b>51</b> Adverbs 1	94
<b>20</b> Let's get technical	36	<b>52</b> Anagrams	95
<b>21</b> Toiletries, make-up and medicine	37	<b>53</b> More word building	96
<b>22</b> Verbs crossword	38	<b>54</b> Green issues	98
<b>23</b> Animals	40	<b>55</b> Adjectives and nouns	100
<b>24</b> Compound nouns 1	42	<b>56</b> Same word, different meaning	102
<b>25</b> Clothes	44	<b>57</b> Rhyming words	104
<b>26</b> Choose the word	46	<b>58</b> Adverbs 2	105
<b>27</b> Cartoons 1	48	<b>59</b> Choose the adjective	106
<b>28</b> Compound nouns 2	50	<b>60</b> What's the verb?	107
<b>29</b> Sports and leisure equipment	52	Answers	108
<b>30</b> Abstract nouns	54	Word list	116
<b>31</b> Verbs: world of work	56		

# To the student

This book will help you to learn new English words while having fun at the same time. Many of the tests use pictures – such as the tests on things in the home, food and drink, fruit and vegetables, sports equipment and clothes. Others are based on word types – for example, verbs, adjectives, prepositions and adverbs. There are also tests on pairs of words that have similar meanings, opposites, and words that people often mix up. Use the contents list to find the right test for you. Or go through the book and choose one that looks interesting or has drawings that you like. So if you feel like doing a crossword, choose a crossword. If you feel like looking at cartoons, try one of the *Phrases* tests where you match words to a picture. If a test is fun to do, this is one of the best ways of learning new words fast. There's no need to start at the beginning and work through every test in the book. The tests at the end are no more difficult than the ones at the beginning.

There are tip boxes on nearly every page. They will give you extra help and information. They will also give you ideas on how to learn new words.

To really **learn** a new word, you will need to do each test more than once. So use a pencil to write the answers in the book when you test yourself. Then, check your answers and look carefully at the words you didn't know or got wrong. Finally, rub out your answers ready for the next time you try that test. Each test will take you between five and fifteen minutes the first time you do it, but the next time you will probably be much quicker.

The tests in this book do not get harder as you go from Test 1 to Test 60. However, the five books in the Test Your Vocabulary series are carefully graded from Book 1 (for beginners) to Book 5, which is for advanced students. If you find this book is too easy, try the next one up. If you find it is too hard, try the next one down.

Good luck with learning the words in this book. And we hope that you will enjoy using the words in real situations once you've learnt them here.

Peter Watcyn Jones and Olivia Johnston

# 1 Things in the home

Write the numbers 1 to 12 next to the correct words.

blender	4	1	
bottle opener	_____	2	
briefcase	_____	3	
broom	_____	4	
coat hanger	_____	5	
dustpan	_____	6	
light bulb	_____	7	
pepper grinder	_____	8	
potato peeler	_____	9	
suitcase	_____	10	
tea towel	_____	11	
tray	_____	12	



- A *tea towel* is something we use to dry the dishes after we have done the washing-up. In American English it is called a *dish cloth*.
- All but three of the items on this page are compound nouns. Some compound nouns are written as one word like *briefcase*, *suitcase* and *dustpan*. Some are written as two words like *bottle opener* and *tea towel*. Can you think of another compound noun ending with the word ... *opener* and another one ending with the word ... *towel*?

# 2 Adjectives: people 1

The adjectives in the box below are all in the crossword. Read the clues and complete the crossword with them.

brave generous grateful honest independent jealous  
lively mature miserable patient popular proud  
relaxed reliable sensible superficial warm weird

## Across

- 1 She doesn't think about anything seriously or have any deep feelings. She's so \_\_\_\_\_
- 6 He's always \_\_\_\_\_. He's never in a hurry and he's always calm.
- 8 She's the most \_\_\_\_\_ person in the school. Everybody likes her.
- 10 He's very \_\_\_\_\_. If he says he'll do something, then he does it.
- 13 She's very \_\_\_\_\_. She never complains about the pain she is in all the time.
- 14 She always tells the truth. She's very \_\_\_\_\_
- 15 He's a very \_\_\_\_\_ teacher. He doesn't get cross even when he has to repeat something three times.
- 17 They were very \_\_\_\_\_ when we said they could stay in our house while we were away.

## Down

- 1 He never drinks and drives. He's too \_\_\_\_\_ to do something silly like that.
- 2 She's going to travel around the world for six months on her own. She must be very \_\_\_\_\_
- 3 She always has fun at parties because she's so bright and \_\_\_\_\_
- 4 He never smiles and always looks \_\_\_\_\_. I don't know what his problem is.
- 5 She's only seventeen but she seems much older. She's very \_\_\_\_\_ for her age.

- 7 He makes her \_\_\_\_\_ when he looks at other girls.
- 9 She looks \_\_\_\_\_. Why does she always wear such strange clothes?
- 11 They're very rich but they are also really \_\_\_\_\_ with their money. They give wonderful presents.
- 12 He got 100% in all his exams. His parents are really \_\_\_\_\_ of him.
- 16 She's always \_\_\_\_\_ and friendly. You always feel welcome at her house.

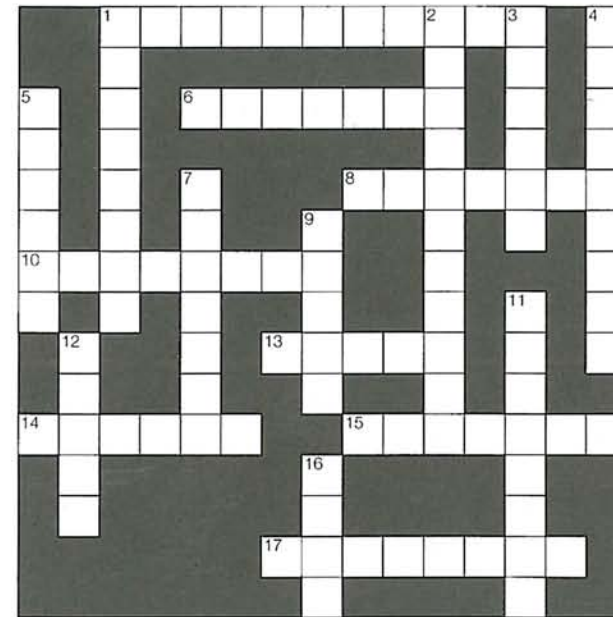

The word *sensible* may be a 'false friend' for many students of English whose mother tongue has Latin roots. In English, *sensible* means *clever in a practical way*.

*She won't take any silly risks. She's a sensible girl.*

It does not mean the same as *sensitive*, which means *easily hurt or delicate*.

*She can't use soap on her face. She's got very sensitive skin.*

*Don't tease him. He's very sensitive and you might make him cry.*

# 3 Phrasal verbs 1

Complete each sentence with a phrasal verb in the correct tense. Sometimes you will have to separate the verb from the particle.

blow up   break down   bring up   cut down   ~~get over~~   hang up  
keep on   knock out   let down   pick up   put off   put out  
ring off   run out of   set out   show off   take off   tell off   turn up

- 1 Have you got over that terrible cough you had last time I saw you?
- 2 He touched one of the sculptures in the exhibition, and the guard saw him and \_\_\_\_\_ him \_\_\_\_\_.
- 3 Her car \_\_\_\_\_ petrol and she had to hitchhike to a petrol station.
- 4 Her husband left her when the children were babies and she \_\_\_\_\_ them \_\_\_\_\_ herself.
- 5 I know you don't want to talk to Jenny but it's really important to do it today. You can't \_\_\_\_\_ it \_\_\_\_\_ any longer.
- 6 Jimmy's giving me a lift. He's \_\_\_\_\_ me \_\_\_\_\_ tomorrow morning at eleven.
- 7 My little sister often \_\_\_\_\_ when we have visitors. She wants to get more attention.
- 8 Our car \_\_\_\_\_ on the motorway and we had to call a garage to get it fixed.
- 9 Our plane \_\_\_\_\_ an hour late so we landed in Rome an hour later than we'd expected.
- 10 Please \_\_\_\_\_ your cigarette. Can't you see the 'no smoking' sign?

- 11 She \_\_\_\_\_ asking me for money so in the end I had to give her some.
- 12 Terrorists put a bomb under the bridge and \_\_\_\_\_ it \_\_\_\_\_.
- 13 The robber hit the bank manager over the head and \_\_\_\_\_ him \_\_\_\_\_. He was unconscious for half an hour.
- 14 Tony still hadn't arrived by ten. Eventually he \_\_\_\_\_ at 11.30 with two other people.
- 15 We \_\_\_\_\_ on our trip quite early but there was already a lot of traffic on the road.
- 16 We \_\_\_\_\_ the tree in the front of our house because we didn't get any light in our sitting room.
- 17 We promised to go and visit her tomorrow so we have to. We can't \_\_\_\_\_ her \_\_\_\_\_. She'd be so disappointed.
- 18 We were talking on the phone and suddenly she just \_\_\_\_\_. Maybe somebody rang at her front door.



The one-word synonym of to *get over* (an illness) is to *recover*. The one-word synonym of to *tell someone off* is to *admonish someone*. Phrasal verbs are more informal and much more common even in written English than their one-word synonyms.

**Question:** What's the difference between a nail and a boxer?

**Answer:** One gets knocked in and the other gets knocked out.

# 4 The body

Write the numbers 1 to 12 next to the correct words.

ankle 12      chin \_\_\_\_\_      throat \_\_\_\_\_  
 bottom \_\_\_\_\_      elbow \_\_\_\_\_      thumb \_\_\_\_\_  
 cheek \_\_\_\_\_      lips \_\_\_\_\_      waist \_\_\_\_\_  
 chest \_\_\_\_\_      stomach \_\_\_\_\_      wrist \_\_\_\_\_

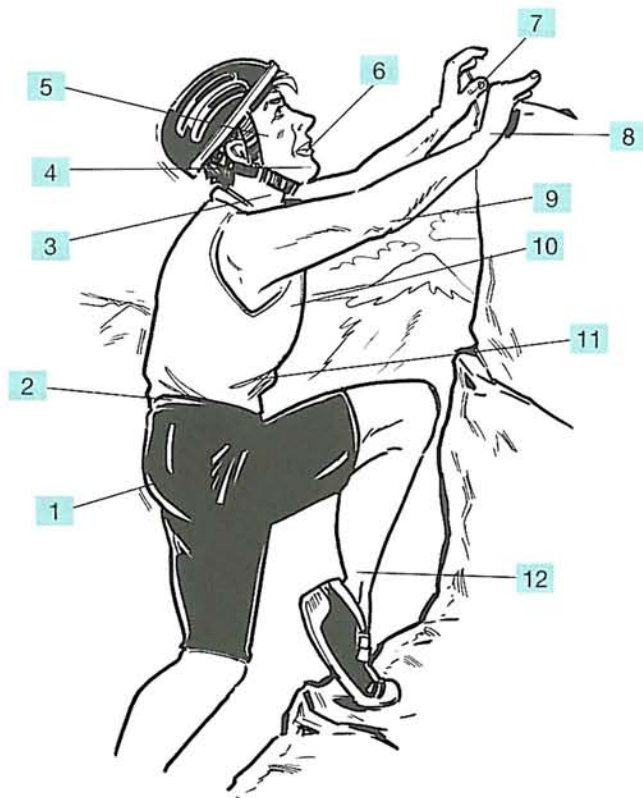

# 5 Food and drink 1

Match the pairs of adjectives on the left to the nouns on the right.

- |    |                       |          |   |               |
|----|-----------------------|----------|---|---------------|
| 1  | baked or mashed       | <u>k</u> | a | boiled eggs   |
| 2  | fried or scrambled    | _____    | b | bread         |
| 3  | brown or white        | _____    | c | cola          |
| 4  | fried or grilled      | _____    | d | chocolate     |
| 5  | hard or soft          | _____    | e | cream         |
| 6  | hot or mild           | _____    | f | curry         |
| 7  | plain or milk         | _____    | g | eggs          |
| 8  | rare or medium        | _____    | h | fish          |
| 9  | regular or diet       | _____    | i | milk          |
| 10 | skimmed or full-cream | _____    | j | mineral water |
| 11 | single or double      | _____    | k | potatoes      |
| 12 | still or sparkling    | _____    | l | tea           |
| 13 | strong or weak        | _____    | m | steak         |
| 14 | sweet or dry          | _____    | n | tomatoes      |
| 15 | tinned or fresh       | _____    | o | wine          |



We also talk about *black* or *white* tea and coffee, *red* or *white* wine and *strong* or *mild* cheese.

# 6 The house and garden

Write the numbers 1 to 16 next to the correct words.

- |                      |                      |
|----------------------|----------------------|
| branch <u>4</u>      | greenhouse _____     |
| burglar alarm _____  | hedge _____          |
| bush _____           | hose _____           |
| chimney _____        | lawn _____           |
| door handle _____    | letterbox _____      |
| dustbin _____        | patio _____          |
| flowerpot _____      | satellite dish _____ |
| French windows _____ | tap _____            |

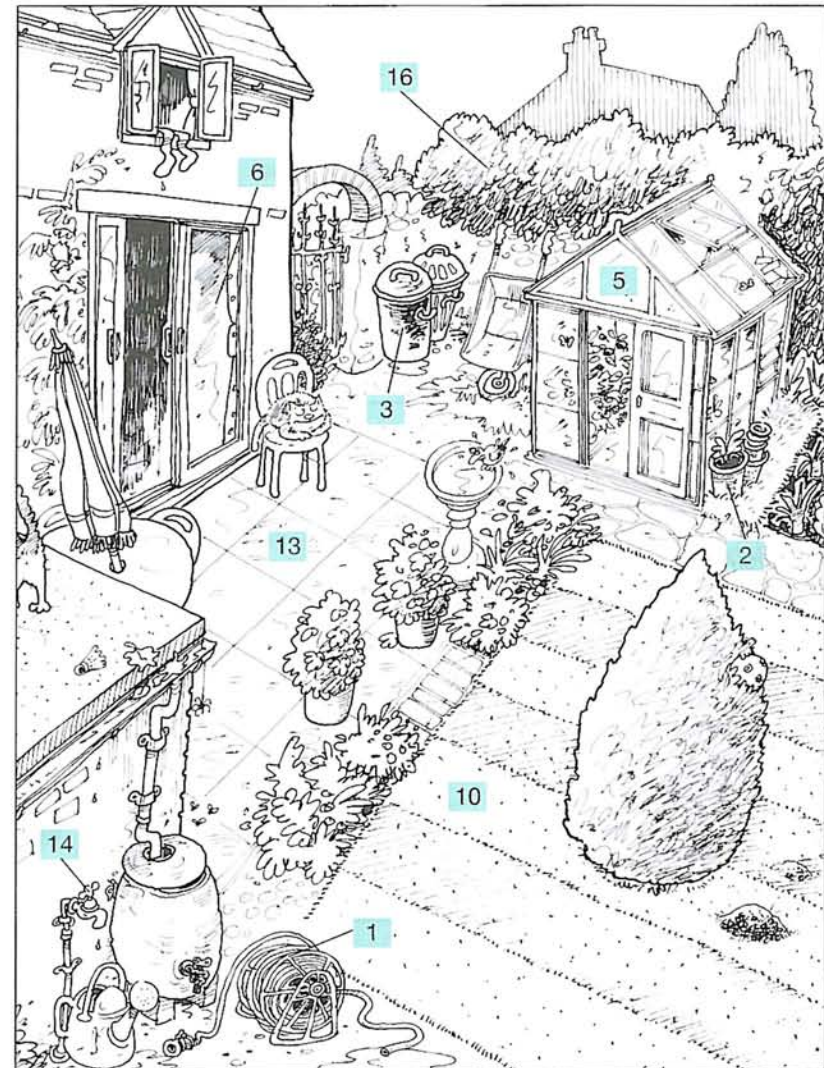
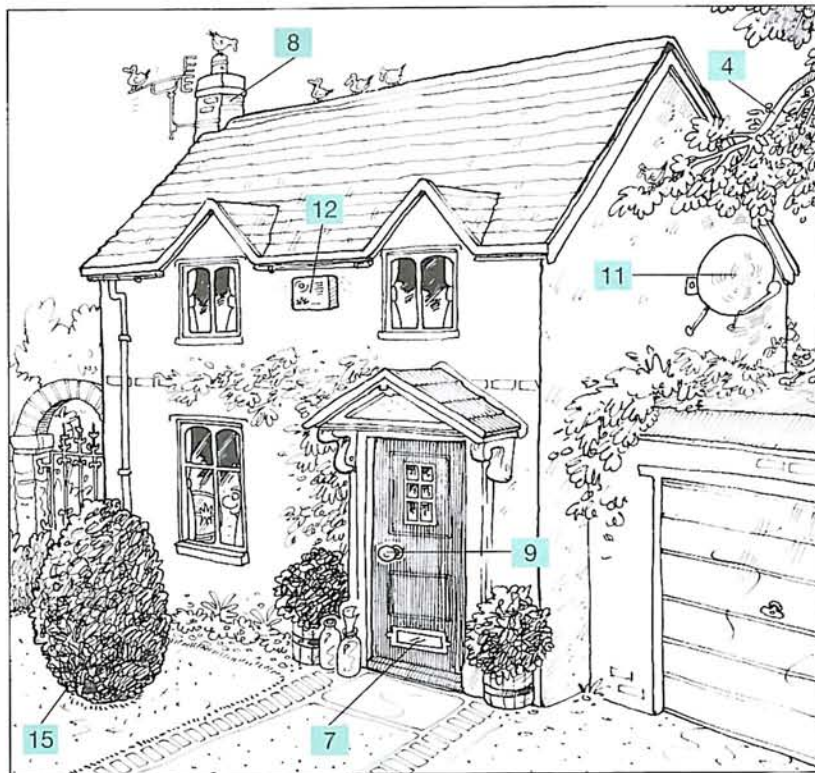

In America, a garden is usually called a *yard*. In British English, the word *yard* is uncommon. It means a *small paved or concrete area at the back of the house*. The modern word for a paved area at the back of the house is a *patio*.



# 7 Adjectives: opposites

Match the adjectives in the box to their opposites. Then complete the sentences a) – j) with one of the adjectives on the page.

artificial   broad-minded   cautious   delicious   exciting   gentle  
light-hearted   pessimistic   ~~rational~~   sensitive   sudden   tiny  
uninterested   unlucky

- |    |               |                 |
|----|---------------|-----------------|
| 1  | emotional     | <u>rational</u> |
| 2  | gigantic      | _____           |
| 3  | real          | _____           |
| 4  | dull          | _____           |
| 5  | daring        | _____           |
| 6  | narrow-minded | _____           |
| 7  | gradual       | _____           |
| 8  | keen          | _____           |
| 9  | lucky         | _____           |
| 10 | thick-skinned | _____           |
| 11 | serious       | _____           |
| 12 | optimistic    | _____           |
| 13 | disgusting    | _____           |
| 14 | aggressive    | _____           |

- a She's a very emotional person. She's always laughing or crying or falling in love.
- b The food at the hotel was absolutely \_\_\_\_\_. None of us could eat it.
- c He is very \_\_\_\_\_. You can say anything and he won't be shocked.
- d He enjoys picking fights with people. He really is \_\_\_\_\_.
- e At first I didn't realise those roses were \_\_\_\_\_. I tried smelling one of them.
- f The improvement in his health was very \_\_\_\_\_. At first we didn't notice that he was getting better.
- g She's very \_\_\_\_\_. She's always cheerful and never gets depressed.
- h I wish I was more \_\_\_\_\_. I'd like to try surfing or going up in a hot air balloon but I'm too scared.
- i He's very \_\_\_\_\_. He always thinks something bad is going to happen to him.
- j She gets very upset if people don't like her paintings. She's terribly \_\_\_\_\_ about her work.



Test 2 on pages 2–3 also practises adjectives. The Tip on page 3 explains the difference between *sensible* and *sensitive*.

# 8 Crime

Complete each sentence with the correct word from the box.

bullies   ~~burglar~~   dealers   drink driving   fine   gangs  
graffiti   hooligans   judge   mugged   robbers  
shoplifting   speeding   theft   violence

- 1 A burglar broke into our house while we were away this weekend and stole our video.
- 2 Drug \_\_\_\_\_ who sell heroin to teenagers are among the worst kind of criminals.
- 3 Car \_\_\_\_\_ in this area is increasing. Fifty cars were stolen last week.
- 4 Fourteen football \_\_\_\_\_ were arrested after the match. They were fighting and throwing bottles onto the pitch.
- 5 He should have taken a taxi home after the party. He got stopped by the police and lost his licence for \_\_\_\_\_.
- 6 He was doing 80 kilometres an hour in the centre of town. He was caught \_\_\_\_\_ on a camera.
- 7 He's scared to walk home from school on his own because last week some \_\_\_\_\_ in the year above him broke his personal stereo.
- 8 If you park on a double yellow line, you might get a parking \_\_\_\_\_.
- 9 In court, the \_\_\_\_\_ said he should stay in prison for the rest of his life.

- 10 She was arrested for \_\_\_\_\_. She stole a pair of jeans and a sweater from a clothes shop.
- 11 Some people think that the \_\_\_\_\_ on TV and in films leads to crime.
- 12 The health centre wall has some big red \_\_\_\_\_ on it. They'll have to repaint the wall.
- 13 There was a big fight between two \_\_\_\_\_ of teenagers outside the club. Seventeen people were hurt.
- 14 Two armed bank \_\_\_\_\_ got away with £50,000 yesterday.
- 15 Two guys \_\_\_\_\_ a friend of mine recently and ran off with her handbag.



The words *robbers* and *rob* are usually used about banks, post offices and jewellery shops.

*Robbers got away with £2 million from a high street bank yesterday.  
Two armed men robbed a jewellery shop this morning.*

When we speak about theft from a house, we usually use the words *burglars*, *burgle* and *break into*.

**Question:** Who are the strongest criminals in the world?

**Answer:** Shoplifters.

**Question:** What did the hooligan say after breaking all the windows?

**Answer:** I've had a smashing time.

# 9 Jobs

Complete the sentences with the correct words from the box.

astronaut   caretaker   cashier   chef   diver   driving instructor  
 engineer   estate agent   farmer   lawyer   lifeguard   ~~model~~  
 pilot   speech therapist   surgeon

The group of people I was friendly with at college have all got very different jobs.

- 1 Elana is very beautiful and slim. You've probably seen her wearing expensive clothes on the covers of magazines. She's a model.
- 2 Naomi is a \_\_\_\_\_. She helps people who have problems speaking. Sometimes they've had an accident or an illness, and sometimes they were born with the problem.
- 3 Jo's a \_\_\_\_\_. He's got a lot of fruit trees and he also keeps sheep and cows.
- 4 Steve is a \_\_\_\_\_ in a bank. He loves counting money!
- 5 Tony looks after a big block of flats. He says being a \_\_\_\_\_ is great because he gets his own free flat with the job.
- 6 Sandra is always in her car. She's a \_\_\_\_\_. Everyone she teaches passes their test first time.
- 7 Rose is a \_\_\_\_\_. At the moment she flies a small plane from London to Paris three times a week.
- 8 Bob has the most unusual job. He's an \_\_\_\_\_. His ambition is to set up a new space station.
- 9 Tom is an \_\_\_\_\_. He helps people to buy and sell houses and flats.

- 10 Katie is a \_\_\_\_\_ in a big hotel. I've never eaten there but people say the food is amazing.
- 11 Alex repairs oil rigs underwater. He is a deep-sea \_\_\_\_\_.
- 12 Karen is a \_\_\_\_\_. She used to spend a lot of time in court but now she helps people sort out property and money when they get divorced.
- 13 Glenn is an \_\_\_\_\_ with a big telephone company. When people have problems with their phones, they call him.
- 14 I had to have an operation on my knee last year. My friend Luisa is a \_\_\_\_\_ at the Fleming Hospital and she did it.
- 15 Ben loves the sea. He owns a surfing shop and he also works as a \_\_\_\_\_ on a big beach in Cornwall. Last summer he saved a little boy from drowning.



Try consolidating your knowledge of jobs words by making an occupations word-web. Start like this:

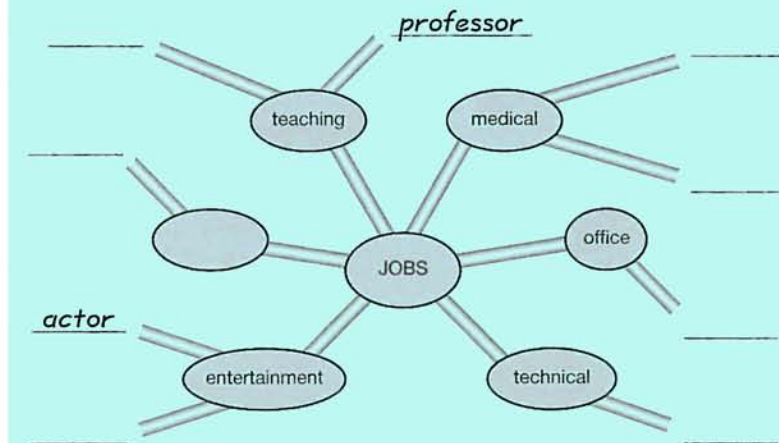

# 10 Food and drink 2

Write the numbers 1 to 12 next to the correct words.

beat 6

roast \_\_\_\_\_

chop \_\_\_\_\_

slice \_\_\_\_\_

grate \_\_\_\_\_

spread \_\_\_\_\_

heat \_\_\_\_\_

squeeze \_\_\_\_\_

mix \_\_\_\_\_

stir \_\_\_\_\_

peel \_\_\_\_\_

whip \_\_\_\_\_



*Beating* and *whipping* are very similar actions. We generally say *beat* for eggs and *whip* for cream.

**Question:** Why are cooks cruel?

**Answer:** Because they are always beating eggs and whipping cream.

# 11 Choose the word

Choose the word which best completes each sentence.

1 Anyone wanting to go to the meeting, please put up your hands.

- a) take up       b) put up  
c) lift          d) rise

2 I have no brothers or sisters. I am \_\_\_\_\_ child.

- a) an only      b) one  
c) a unique    d) a single

3 I'm terribly sorry, I seem to have \_\_\_\_\_ my book at home.

- a) lost          b) forgotten  
c) left          d) hidden

4 My sister and I are always quarrelling. We just don't seem to \_\_\_\_\_.

- a) get off      b) get together  
c) get on      d) get by

5 A lot of single parents find it difficult to \_\_\_\_\_ their children and do a job.

- a) grow up     b) take up  
c) develop     d) bring up

6 We \_\_\_\_\_ to inform you that this flight will be delayed for five hours.

- a) sorry        b) regret  
c) apologise   d) pity

7 Everyone should \_\_\_\_\_ this charity. They're doing a lot of good work in developing countries.

- a) agree        b) support  
c) stand up    d) supply

8 I only paid £5 for this shirt. It was a real \_\_\_\_\_.

- a) luck         b) sale  
c) bargain     d) cheap

9 I always try to \_\_\_\_\_ something each month for my holidays.

- a) save         b) spare  
c) spend       d) put

10 I don't have a job. I'm \_\_\_\_\_.

- a) lonely       b) sick  
c) unused      d) unemployed

11 Juventus \_\_\_\_\_ AC Milan in the football final.

- a) beat         b) won  
c) passed      d) lost

12 The train now standing at \_\_\_\_\_ seven has just arrived from Brighton.

- a) station      b) platform  
c) lane         d) path



If you make a lot of mistakes in this test, try writing sentences with the words that confused you. Then do the test again in a few days' time.

# 12 Fruit and vegetables

Write the numbers 1 to 14 next to the correct words.

aubergine 4      coconut \_\_\_\_\_      peach \_\_\_\_\_  
 broccoli \_\_\_\_\_      courgette \_\_\_\_\_      pepper \_\_\_\_\_  
 cabbage \_\_\_\_\_      cucumber \_\_\_\_\_      plum \_\_\_\_\_  
 cauliflower \_\_\_\_\_      fig \_\_\_\_\_      tangerine \_\_\_\_\_  
 cherry \_\_\_\_\_      onion \_\_\_\_\_

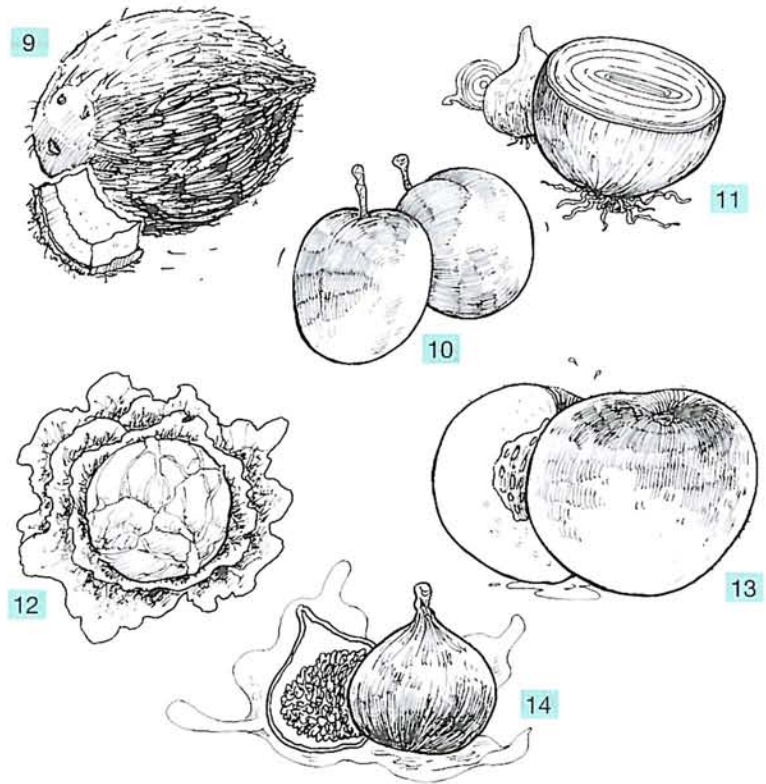
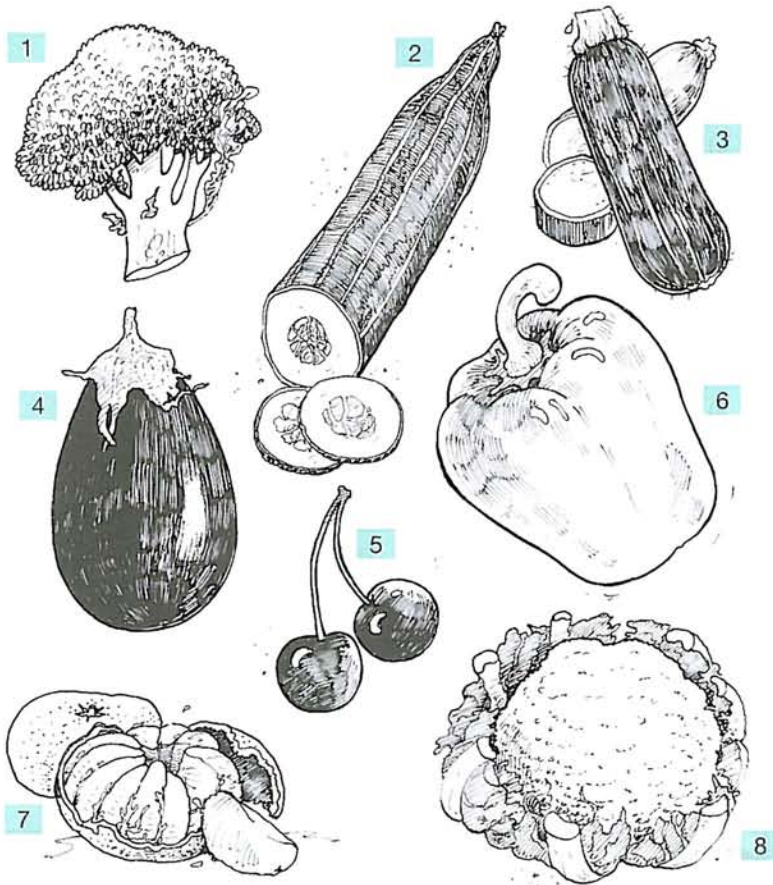

- There are lots of fruits similar to tangerines but which have different names, for example *clementines*, *mandarins*, *satsumas*. Most people don't know the difference between them and nobody really cares apart from greengrocers. The most useful general word for all of them is probably *tangerine*.
- On the night of Christmas Eve in Britain, children hang out a sock (called a stocking, for some reason at Christmas!) for Father Christmas to fill with presents while they are asleep. It's traditional for Father Christmas to put a tangerine and some nuts at the bottom of the stocking, in the toe. The tradition originates from the time when tangerines were luxuries.

# 13 Getting a job

Complete the conversation with the correct words from the box.

advertisement ~~application form~~ career CV driving licence  
full-time interview offer organized part-time qualifications  
references sense of humour skills starting salary stressful  
temporary training course unemployed well-paid

A: Did you have to fill in an (1) application form to get your job?

B: No. I saw an (2) \_\_\_\_\_ in the newspaper for a job as a runner for a TV company and I wrote them a letter. I also sent them my (3) \_\_\_\_\_ with details of my education and other work experience. In my letter I said that I had always wanted a (4) \_\_\_\_\_ in TV and was happy to start at the bottom.

A: Were you nervous when you went for your (5) \_\_\_\_\_?

B: Yes, I was a bit. But they were very friendly and gave me a coffee.

A: What questions did they ask you?

B: They asked if I had a clean (6) \_\_\_\_\_ because I might have to do some driving. They also wanted to know about my computer (7) \_\_\_\_\_ and I told them I knew Word and Excel.

A: Did you need any other (8) \_\_\_\_\_ for the job?

B: No. But I think you have to be well (9) \_\_\_\_\_ for this kind of work, or you can't get everything done in time. And you also need a good (10) \_\_\_\_\_.

A: Really?

B: Yes. Because sometimes, if you didn't laugh, you'd cry!

A: Did they (11) \_\_\_\_\_ you the job straightaway?

B: No. They asked me for (12) \_\_\_\_\_. They wanted the name and address of my boss at my last company. And I also gave them the name of a woman I worked for in Italy.

A: Is it a (13) \_\_\_\_\_ job?

B: Yes. I work forty hours a week.

A: Do you make good money? Is it (14) \_\_\_\_\_?

B: No, but I don't mind. I'm not doing it for the money. My (15) \_\_\_\_\_ was really low but it went up after two months.

A: Is it a permanent job or is it (16) \_\_\_\_\_?

B: Well, I've got a twelve-month contract. They might renew it after that.

A: Do you find the work (17) \_\_\_\_\_?

B: No. It's hard work but the atmosphere is very relaxed. Anyway tell me about you. Are you still (18) \_\_\_\_\_?

A: No, I've got a job at last, but it's only (19) \_\_\_\_\_ – twenty hours a week. But they're sending me on a (20) \_\_\_\_\_ next week to improve my computer skills and after that they may offer me more hours.



- A *runner for a TV company* is someone who walks or runs from place to place carrying messages.
- The word *advertisement* is often abbreviated to *advert* or *ad*.
- The letters *CV* stand for the Latin phrase *curriculum vitae* which means literally *the racecourse of life*. In American English, a CV is usually called a *resumé*.

# 14 Verbs: communicating

Complete each sentence with a verb from the box in the correct form.

advertise   advise   congratulate   contact   demand   deny  
explain   inform   insult   interrupt   persuade   present  
remind   translate   warn   ~~whisper~~

- 1 'Ssh! Don't make a noise,' he whispered. 'We don't want to wake the others up, do we?'
- 2 This is going to hurt a little,' the doctor \_\_\_\_\_ her.
- 3 'We regret to \_\_\_\_\_ you that flight BR 243 is delayed for three hours.'
- 4 I \_\_\_\_\_ to her three times how to use my mobile, but she still couldn't make a call.
- 5 I almost forgot to return the videos to the video shop. Luckily Claude \_\_\_\_\_ me.
- 6 I hate him. He called me a stupid idiot and \_\_\_\_\_ me in various other ways.
- 7 I know he copied his essay off the Internet, but he continues to \_\_\_\_\_ it.
- 8 She \_\_\_\_\_ me not to do the computer course but I'm still thinking of doing it because it might be useful.
- 9 At first I wanted to go to California on holiday but in the end we went to Maine because my sister \_\_\_\_\_ me it would be more fun. It was definitely the right choice.

- 10 Martha hasn't \_\_\_\_\_ me about the trip next week. I don't think she wants to come.
- 11 On Radio 6, they are \_\_\_\_\_ some very cheap flights to Florida at the moment.
- 12 Our first night in the hotel was terrible. The next morning we \_\_\_\_\_ to see the manager.
- 13 She didn't speak a word of Spanish so I had to \_\_\_\_\_ for her when we were in Madrid.
- 14 We were trying to have a conversation but her little boy kept \_\_\_\_\_ us.
- 15 While everyone was \_\_\_\_\_ the bride and groom after the wedding, we disappeared.
- 16 You look a bit like the guy who \_\_\_\_\_ the TV programme Lucky Day.



Don't forget the correct usage of the basic verbs: *say*, *speak*, *talk* and *tell*.

The verbs *say*, *speak*, *talk* can be used without an object:

*He said that he was busy.*

*She spoke about her life in Africa.*

*They talked for hours.*

These verbs can also be followed by *to* and an indirect object:

*What did she say to you?*

*Who were you speaking / talking to?*

The verb *tell* has to have an object:

*I told him to leave.*

*She told him a lie / the truth / the answer / a story / the time.*



# 15 Verbs: body and mind

Complete each sentence 1–16 with a verb from the box in the correct form. Then match the sentences to the correct response a)–p).

bleed blow ~~breathe~~ comfort cure dream examine faint  
hug relax rest scratch scream sneeze snore weep

- 1 Breathe in through your nose and out through your mouth.  
\_j\_
- 2 Don't \_\_\_\_\_ those mosquito bites. \_\_\_\_\_
- 3 What a fabulous cake! Can I \_\_\_\_\_ out the candles? \_\_\_\_\_
- 4 How can I stop my husband \_\_\_\_\_? He keeps me awake at night. \_\_\_\_\_
- 5 I \_\_\_\_\_ out loud when the bad guy jumped out of the cupboard. \_\_\_\_\_
- 6 I couldn't help \_\_\_\_\_ when my old cat died. \_\_\_\_\_
- 7 I'm about to \_\_\_\_\_. Atishoo! \_\_\_\_\_
- 8 I'm going to \_\_\_\_\_ your throat. Can you open your mouth?  
\_\_\_\_\_
- 9 Let's have a drink then go and \_\_\_\_\_ by the pool. \_\_\_\_\_
- 10 I've cut my finger. It's \_\_\_\_\_. \_\_\_\_\_
- 11 When she saw the blood, she \_\_\_\_\_ and fell on the floor.  
\_\_\_\_\_
- 12 That medicine has \_\_\_\_\_ my stomach ache. I feel fine now.  
\_\_\_\_\_
- 13 She saw him off at the airport and they \_\_\_\_\_ and kissed for five minutes. \_\_\_\_\_
- 14 We did our best to \_\_\_\_\_ her when she heard the bad news.  
\_\_\_\_\_
- 15 What did you \_\_\_\_\_ about last night? \_\_\_\_\_
- 16 You look tired. Why don't you go and \_\_\_\_\_ for an hour?  
\_\_\_\_\_

- a Bless you!
- b Yes, and you can make a wish.
- c Good idea. Don't you love holidays!
- d Great! But you'd better not eat any rich food for a couple of days.
- e How long was she unconscious?
- f I can't help it. They're terribly itchy.
- g I can't remember. But I woke up screaming.
- h I know how you feel. I cried when my dog died.
- i I'll put a plaster on it.
- j But my nose is blocked.
- k Make him sleep in another room!
- l OK. I feel very tired after that journey.
- m OK, Dr Fernandez.
- n So did I. It was so scary.
- o Was she really upset, then?
- p How long is he going away for?



At birthday parties in Britain (and many other countries), the tradition is that if you manage to blow out all the candles on your birthday cake, you can make a wish. Some of the other occasions on which you can make a wish, in British culture, are: when you catch a leaf that is falling from a tree; when you see the first evening star; when you see the new moon for the first time; when you pull the wishbone (breastbone) of a chicken or turkey with another person until it breaks, and you get the bigger bit.

# 16 Verbs: relationships

Complete the sentences with a verb from the box in the correct form.

annoy apologize argue behave communicate criticize embarrass  
~~fancy~~ force offend pretend regret separate share support

- 1 At first, I really fancied him. I found him very attractive.
- 2 We started going out together and we \_\_\_\_\_ everything: money, clothes and even friends.
- 3 After a bit he began to \_\_\_\_\_ me with some of his habits. For example, he used to whistle all the time.
- 4 Sometimes he \_\_\_\_\_ me in front of my friends by drinking too much and telling the same stupid jokes over and over again.
- 5 Once he \_\_\_\_\_ me to go camping with his parents in Wales. I hate camping and I didn't get on with his parents.
- 6 We started to \_\_\_\_\_ about money. He said I was spending too much. I said he wasn't earning enough.
- 7 Once he came round with his mother and she \_\_\_\_\_ me by saying my flat was a mess.
- 8 I told her it was none of her business but David didn't \_\_\_\_\_ me against her.
- 9 I think we both \_\_\_\_\_ badly. He was lazy and passive and I was rude and aggressive.
- 10 I started to \_\_\_\_\_ him in front of people. I used to say he was mean with money, for example.

- 11 I always \_\_\_\_\_ afterwards, but he used to say, 'It's too late to say sorry.'
- 12 I hated spending any time on my own with him. I often went to the cinema in the evenings and \_\_\_\_\_ I was working late.
- 13 By the end of our relationship, we didn't \_\_\_\_\_ at all. We sat in silence all the time.
- 14 Eventually, we \_\_\_\_\_. I haven't seen him since 1998.
- 15 I don't \_\_\_\_\_ splitting up. We weren't happy together.



The phrase *to go out with someone* means to have a romantic relationship. *I used to go out with Jenny's brother when I was sixteen.*  
In American English, the word is *to date*.  
*We dated for about two years before we broke up.*  
*Are Jim and Heidi dating? They're always together these days.*

# 17 Word building: prefixes

A Make the opposites of these adjectives by putting the correct prefix in front of them. Choose from *un-*, *in-*, *im-*.

- |                        |                   |                  |
|------------------------|-------------------|------------------|
| 1 <u>un</u> attractive | 7 ___ healthy     | 13 ___ polite    |
| 2 ___ correct          | 8 ___ interesting | 14 ___ popular   |
| 3 ___ dependent        | 9 ___ mature      | 15 ___ possible  |
| 4 ___ expensive        | 10 ___ moral      | 16 ___ practical |
| 5 ___ fashionable      | 11 ___ patient    | 17 ___ sensitive |
| 6 ___ formal           | 12 ___ pleasant   | 18 ___ usual     |

B Complete the sentences with one of the prefixed adjectives above.

- 1 She is so \_\_\_\_\_. She is seventeen but she acts like a six-year-old.
- 2 He's very \_\_\_\_\_. He doesn't get lonely although he lives on his own and takes all his holidays on his own.
- 3 The band's last CD was very \_\_\_\_\_. Hardly anybody bought it and they never played it on the radio.
- 4 The total is \_\_\_\_\_. They've charged us £15 for the fruit salad!
- 5 This sunny weather is very \_\_\_\_\_. It's normally cold and wet at this time of year.
- 6 Sally has been looking for a job for months. She looked miserable when Maria kept talking about her new job. Maria shouldn't be so \_\_\_\_\_. She should think about Sally's feelings.
- 7 We're having a very \_\_\_\_\_ party on Saturday evening. Come any time after nine and there's no need to dress up.
- 8 He can't even boil an egg or make coffee. In the kitchen he's a very \_\_\_\_\_ person.
- 9 Your diet is very \_\_\_\_\_. You eat too much fat and sugar and not enough fruit and vegetables.

10 She's always stealing from shops. In my opinion, she's completely \_\_\_\_\_.

11 Mes Amis is an excellent restaurant. The food is delicious and it's very \_\_\_\_\_. Even I can afford to eat there!

12 'I'm tired of waiting for this bus. Let's get a taxi.'

'Don't be so \_\_\_\_\_. The bus will be here in another five minutes. We can't afford a taxi.'



- *un-* can go before any letters
- *im-* or *in-*? It's easy to decide. We only use *im-* before the letters *m* and *p*: *immobile*, *improbable*.

# 18 Around the house

Write the numbers 1 to 18 next to the correct words.

- |                    |                     |                   |
|--------------------|---------------------|-------------------|
| banister <u>11</u> | doormat _____       | padlock _____     |
| basket _____       | extractor fan _____ | plate rack _____  |
| board _____        | hat stand _____     | rope _____        |
| bucket _____       | hook _____          | string _____      |
| candle _____       | landing _____       | strip light _____ |
| CD rack _____      | mop _____           | thermometer _____ |

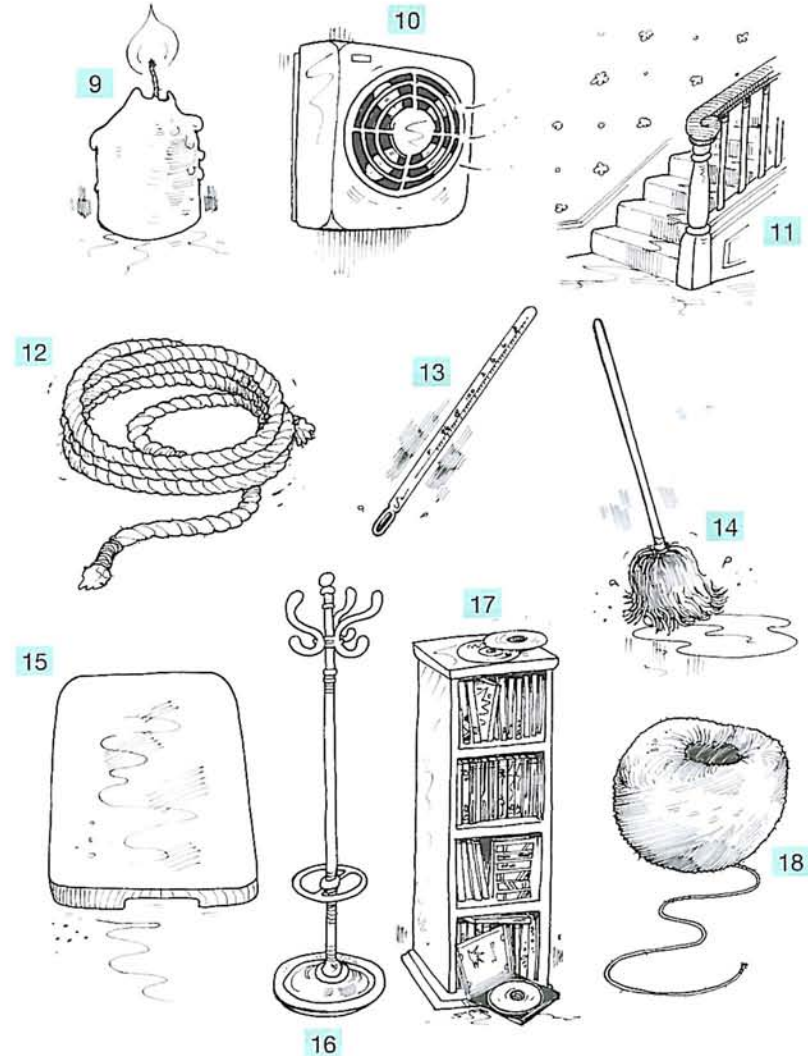
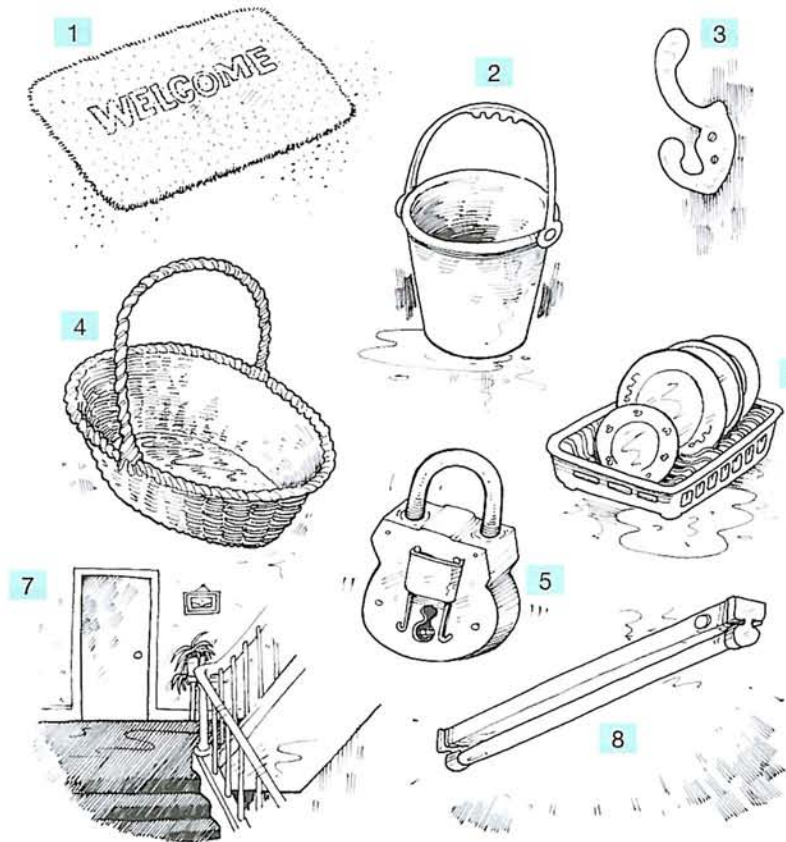

The phrase *hat stand* seems slightly odd since in Britain, most people do not wear hats or hang them up. In fact, a hat stand is the thing we hang our coats on, which usually stands in the entrance hall of a house. In American English it is called, perhaps more sensibly, a *coat stand*.

# 19 Adjectives: people 2

The adjectives in the box below are all in the crossword. Read the clues and complete the crossword with them.

adventurous   ambitious   eccentric   immature   moody  
nosy   obstinate   self-confident   strict   sympathetic  
talented   timid   violent

## Across

- 1 They shouldn't get married at eighteen. They are far too \_\_\_\_\_ to take such an important decision.
- 5 Clive is having another exhibition of his paintings. He's also giving a concert next week. He is a very \_\_\_\_\_ person.
- 7 Tina is so \_\_\_\_\_. If I have a problem, she always listens and tries to help me.
- 8 At the office party, she stood in a corner and didn't speak to anyone. She's very quiet and \_\_\_\_\_
- 9 We've given her lots of good advice but she won't listen. She's very \_\_\_\_\_
- 11 Jackie is so \_\_\_\_\_. One minute she's laughing and the next she's sulking.
- 12 He's a \_\_\_\_\_ man. He was arguing with Tom last night and he ended up pushing him against the wall and shaking him.

## Down

- 2 My uncle cycles around town in a big red hat and long red boots. Everyone stares at him because he looks so \_\_\_\_\_
- 3 She enjoys hot air ballooning and parachute jumping. She's very \_\_\_\_\_
- 4 He wasn't nervous about starting his new job. In fact he was very \_\_\_\_\_ and felt sure that he would do it well and enjoy it.

- 6 Michael already owns three restaurants but he intends to own a chain of them by the time he's thirty-five. He's very \_\_\_\_\_
- 7 Her parents are quite \_\_\_\_\_. She's seventeen but she has to be home by ten o'clock, even at weekends.
- 10 He's always asking me questions about my family and job. He's very \_\_\_\_\_

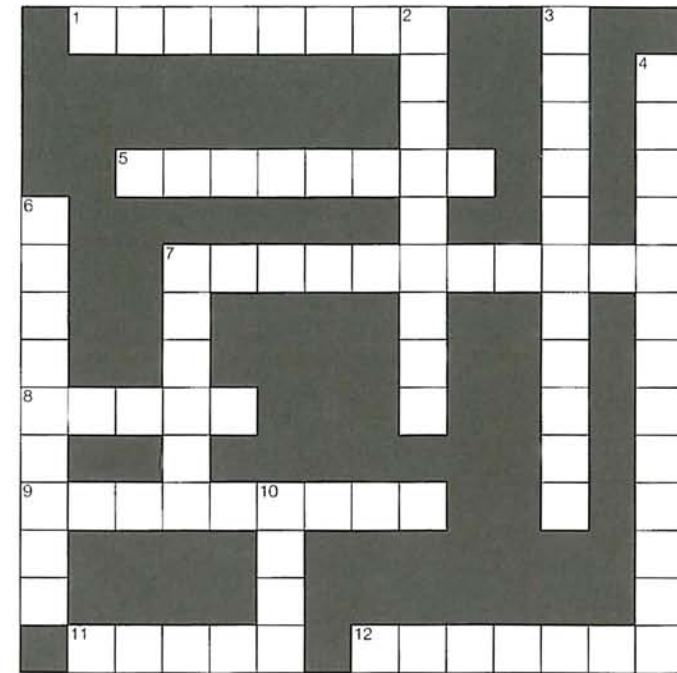

Here's a way of increasing your word power. When you look up a new adjective in the dictionary, check if it has a noun form and write that down as well, for example *immature* (adj), *immaturity* (n).

# 20 Let's get technical

Complete the sentences with the correct words from the box.

backup CD ROM crash download e-card ~~file~~ ~~folder~~  
icon key keyboard laptop virus website

- 1 'I can't find the letter I wrote to Judy anywhere on this computer.'  
'Wasn't it a file called Judy.doc? I think you saved it in the folder called Holidays.'
- 2 Apparently there's a terrible new computer \_\_\_\_\_ that can destroy all the information on your hard disk. The newspapers call it the Letter Bug.
- 3 I can't afford to buy new computer games so I \_\_\_\_\_ them from the Internet.
- 4 Computers are great but when they \_\_\_\_\_, you can lose a lot of your data.
- 5 I found a really interesting \_\_\_\_\_ yesterday with details of jobs and courses abroad. It's called www.jobshop.com.
- 6 If you want to open Internet Explorer, click on the \_\_\_\_\_.
- 7 It's too late to send Jasmine a birthday card to arrive by tomorrow. Let's send her an \_\_\_\_\_ instead.
- 8 I've just bought a \_\_\_\_\_ computer so I can write letters and articles while I'm on my round the world trip.
- 9 The \_\_\_\_\_ is the part of the computer that you type on.
- 10 To get a capital letter, press the shift \_\_\_\_\_ and the letter you want.
- 11 We have all our dictionaries and encyclopedias on \_\_\_\_\_. They take up less space than books.
- 12 You should always make a \_\_\_\_\_ of the work you do on the computer. Then if the computer crashes, you won't lose the work.

# 21 Toiletries, make-up and medicine

Write the numbers 1 to 14 next to the correct words.

- |                     |                     |
|---------------------|---------------------|
| aftershave <u>4</u> | hand cream _____    |
| antiseptic _____    | lipstick _____      |
| aspirin _____       | mascara _____       |
| bandage _____       | plaster _____       |
| blusher _____       | shampoo _____       |
| cotton wool _____   | sponge bag _____    |
| deodorant _____     | talcum powder _____ |



# 22 Verbs crossword

Read the clues and complete the crossword with them.

## Across

- 1 Formal word for *leave*. (6)
- 6 I want to \_\_\_\_\_ a surprise party for Tim. Will you help me? (8)
- 8 The small patch of water on the ceiling is \_\_\_\_\_. Every day it's a bit bigger. (9)
- 12 Can you lend me a suitcase? I have to \_\_\_\_\_ for the weekend. (4)
- 13 I've passed all my exams. We're going to \_\_\_\_\_ tonight. (9)
- 14 There's no need to \_\_\_\_\_. We've got plenty of time. (4)
- 15 Yesterday we \_\_\_\_\_ across the lake in a little boat. (5)
- 16 Stones \_\_\_\_\_ if you drop them in water. (4)
- 17 You \_\_\_\_\_ the way and we'll follow. (4)

## Down

- 1 I love \_\_\_\_\_ into water. It's more fun than jumping. (6)
- 2 She's better now. She has completely \_\_\_\_\_ from her illness. (9)
- 3 To get fit before you go climbing, you'll need to \_\_\_\_\_ (5)
- 4 I wouldn't \_\_\_\_\_ go parachuting. I'd be too scared. (4)
- 5 The bull \_\_\_\_\_ me from one side of the field to the other. (6)
- 7 He was \_\_\_\_\_ and beaten up by a gang outside the club. (8)
- 8 The police are \_\_\_\_\_ for a child who disappeared from his home yesterday. (9)
- 9 Wood \_\_\_\_\_ on water. (6)
- 10 Everyone watched the soldiers as they \_\_\_\_\_ through the streets. (7)
- 11 Formal word for *go in*. (5)

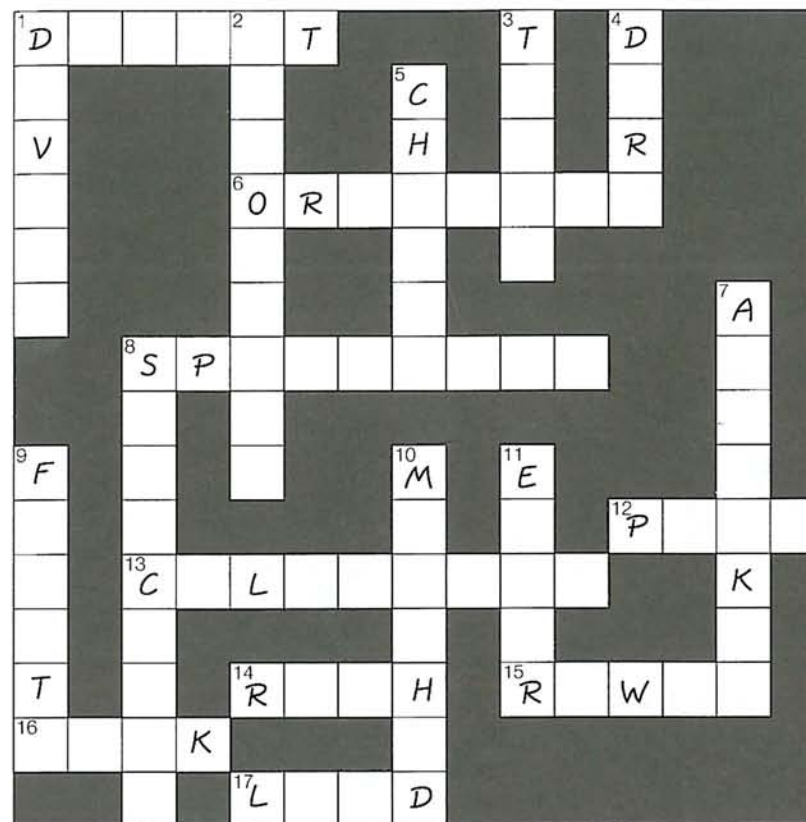

The verb *search* is more common in written than in spoken English. It is followed by *for* when it means *look for*.

*They searched for the keys in every room of the house.*

It is not followed by *for* when it means *to check a place or person*.

*They searched the entire room but they couldn't find the keys.*

*The police searched the men but they didn't find any guns or drugs.*

# 23 Animals

Write the numbers 1 to 18 next to the correct words. Then put the words in the correct group. There are two words for each group.

- |                 |                |                 |
|-----------------|----------------|-----------------|
| bat <u>4</u>    | leopard _____  | swan _____      |
| bee _____       | lizard _____   | tarantula _____ |
| crocodile _____ | mosquito _____ | tortoise _____  |
| frog _____      | salmon _____   | tuna _____      |
| gazelle _____   | scorpion _____ | turkey _____    |
| hedgehog _____  | seal _____     | whale _____     |

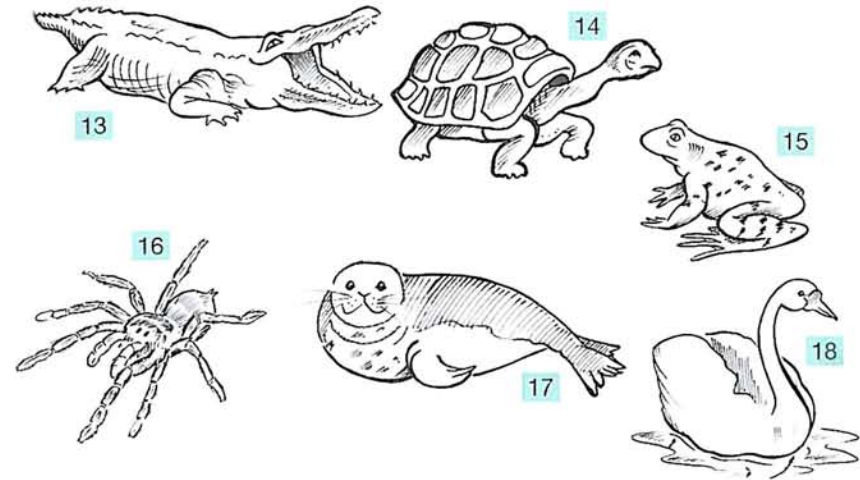
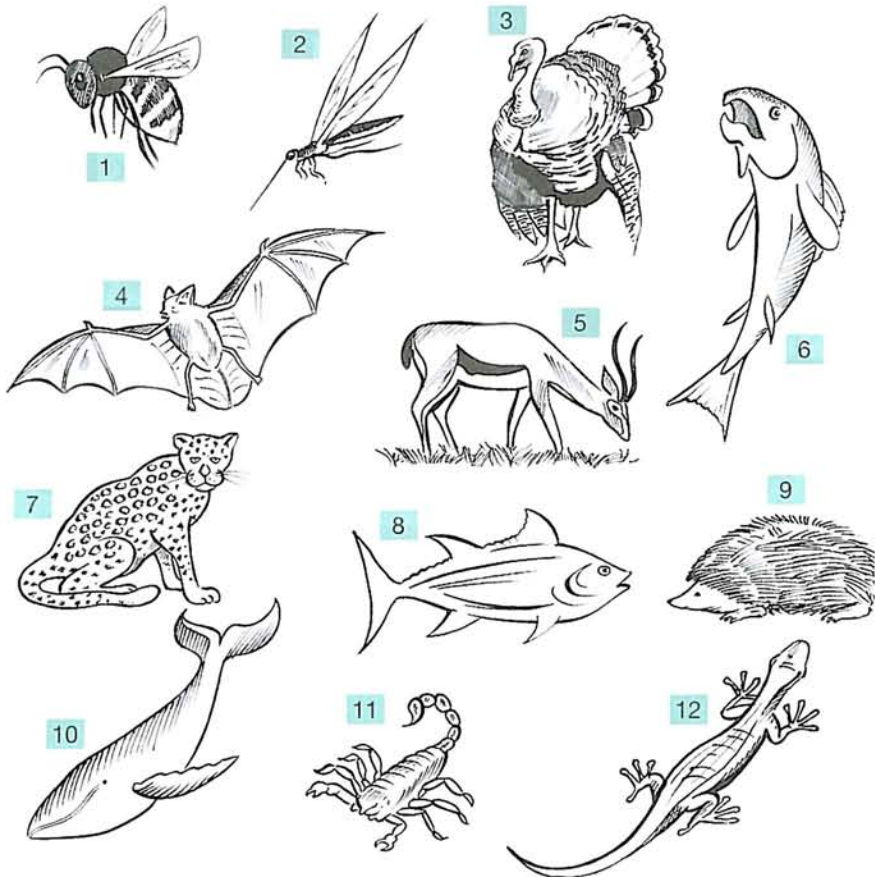

Large birds _____ _____	African mammals _____ _____	Fish _____ _____
Small mammals <i>bat</i> _____ _____	Sea mammals _____ _____	Land reptiles _____ _____
Insects _____ _____	Poisonous animals _____ _____	Animals that live in rivers (not fish) _____ _____



• The first *o* in *leopard* is silent. It is not pronounced.

• **Question:** Where do you weigh a whale?

**Answer:** At a whale-weigh station.

The joke, in case you didn't understand it, is based on the fact that some English people, especially young children, pronounce *r* as *w*.



# 24 Compound nouns 1

A Find words in the box to complete the compound nouns. Write each compound noun.

- 1 clothes peg, clothes line
- 2 \_\_\_\_\_ varnish, \_\_\_\_\_ file
- 3 \_\_\_\_\_ hanger, \_\_\_\_\_ rack
- 4 \_\_\_\_\_ gown, \_\_\_\_\_ table
- 5 \_\_\_\_\_ number, \_\_\_\_\_ directory
- 6 \_\_\_\_\_ brush, \_\_\_\_\_ paste
- 7 \_\_\_\_\_ spray, \_\_\_\_\_ clip
- 8 \_\_\_\_\_ phones, \_\_\_\_\_ ache
- 9 \_\_\_\_\_ cream, \_\_\_\_\_ glasses
- 10 \_\_\_\_\_ polish, \_\_\_\_\_ lace

- clothes-
  - coat
  - dressing
  - hair
  - head
  - nail
  - shoe
  - sun
  - telephone
  - tooth

B Write the correct compound noun under each picture.

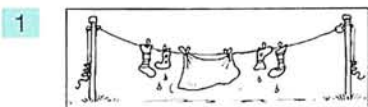

clothes line

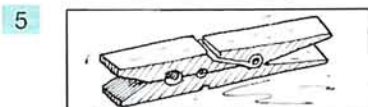
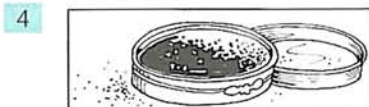
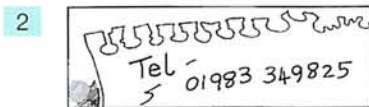

clothes peg

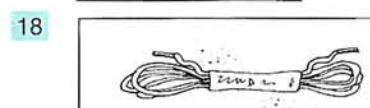
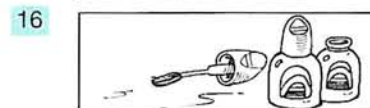
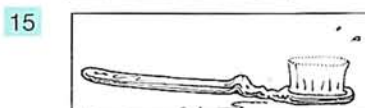
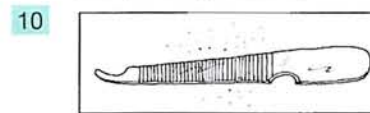
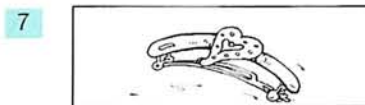

Some compound nouns are written as one word, some as two words and some have a hyphen (-) between the two nouns. Some words can be written in two ways. The forms *email* and *e-mail* are equally common. However, in modern English fewer compound nouns are being hyphenated. People write *ice cream* more commonly than *ice-cream*. Test 28 on pages 50–51 gives further practice of compound nouns.

# 25 Clothes

Write the numbers 1 to 20 next to the correct words.

apron 4    collar \_\_\_\_\_    hood \_\_\_\_\_    underwear \_\_\_\_\_  
 blouse \_\_\_\_\_    cuff \_\_\_\_\_    laces \_\_\_\_\_    uniform \_\_\_\_\_  
 bow tie \_\_\_\_\_    dungarees \_\_\_\_\_    pocket \_\_\_\_\_    vest \_\_\_\_\_  
 button \_\_\_\_\_    heels \_\_\_\_\_    sleeve \_\_\_\_\_    waistcoat \_\_\_\_\_  
 cardigan \_\_\_\_\_    hem \_\_\_\_\_    strap \_\_\_\_\_    zip \_\_\_\_\_

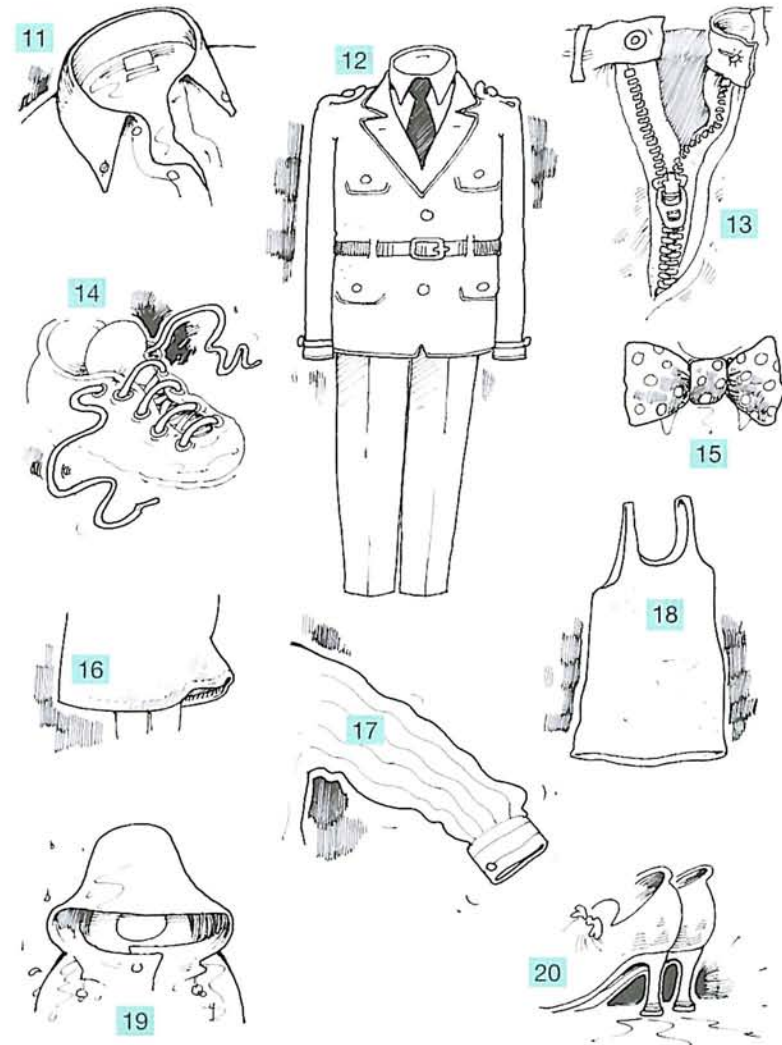
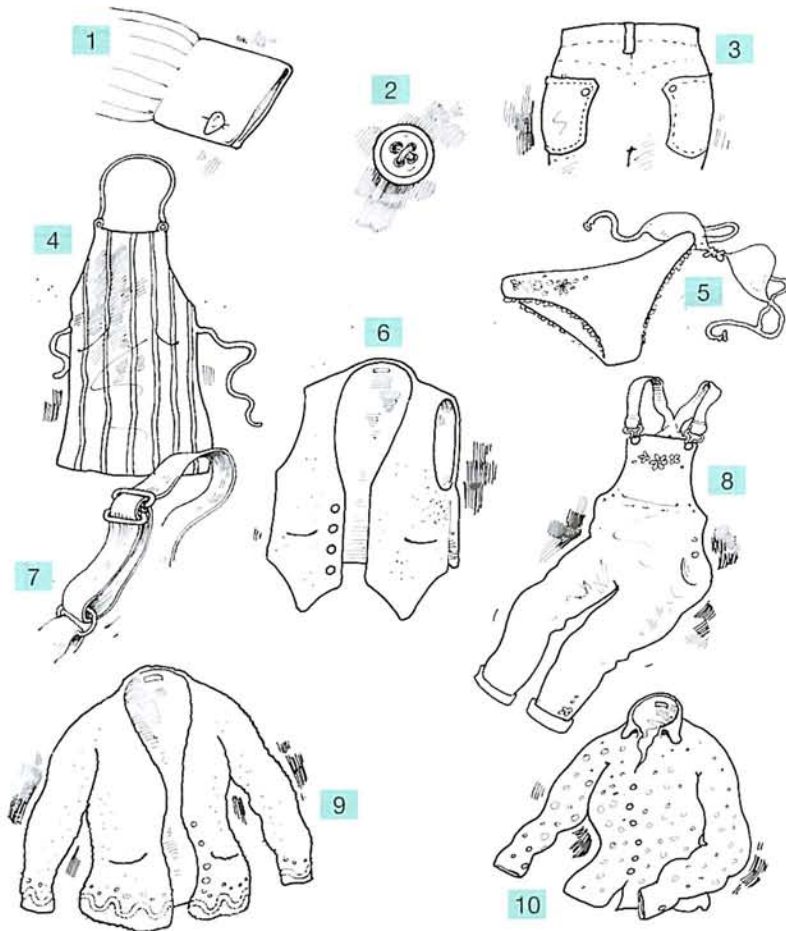

• A *shirt* can be for men or women but a *blouse* is for women only.  
 • A *waistcoat* is called a *vest* in American English. In British English, a *vest* is an item of underwear.

# 26 Choose the word

Choose the word which best completes each sentence.

- 1 His work is getting worse and worse. Unless it improves, he'll fail his exams in the summer.  
a) gets well                      b) improves  
c) increases                      d) gets back
- 2 Oh dear! My watch has \_\_\_\_\_!  
a) ended                          b) stopped  
c) finished                        d) completed
- 3 If you are paid to work for someone, then you are \_\_\_\_\_.  
a) a slave                          b) unemployed  
c) an employer                    d) an employee
- 4 They didn't have a \_\_\_\_\_ of winning against Real Madrid.  
a) luck                              b) wish  
c) time                                d) chance
- 5 The \_\_\_\_\_ around this town is quite beautiful.  
a) countryside                    b) scene  
c) nature                            d) country
- 6 He's always telling me what to do. He's so \_\_\_\_\_.  
a) cruel                              b) bossy  
c) helpful                            d) charming
- 7 Her parents gave her everything she asked for. She was really \_\_\_\_\_.  
a) upset                              b) ashamed  
c) full                                 d) spoilt

- 8 He's really lazy. He always \_\_\_\_\_ doing any of the housework.  
a) gets away from                b) gets back from  
c) gets over                        d) gets out of
- 9 She wants to get to the top before she is thirty. She is very \_\_\_\_\_.  
a) forward                         b) ambitious  
c) intelligent                      d) advanced
- 10 John always arrives on time. He's so \_\_\_\_\_.  
a) careful                          b) boring  
c) punctual                         d) timeless
- 11 I was very \_\_\_\_\_ for all the advice she gave me.  
a) glad                                b) grateful  
c) certain                            d) pleased
- 12 They \_\_\_\_\_ all night to hear the results of the election.  
a) stayed up                        b) sat back  
c) sat out                            d) stayed down



- The word *grateful* is followed by the preposition *for* while *pleased* is followed by *with*.  
*She was grateful for the money.*  
*He was pleased with his present.*
- When *glad* means *grateful*, it is followed by *of*. When *glad* means *happy*, it is followed by *about*.  
*She was glad of our help.*  
*I'm glad about their engagement.*
- The word *certain* can be followed by *of* or *about*.  
*Are you certain of / about this?*

# 27 Cartoons 1

Match the words to the pictures. Write the letters a) to h) in the balloons.

- a Can I give you a hand?
- b Can you keep an eye on them for a minute?
- c Don't bother.
- d I wouldn't do that if I were you.
- e I'll do my best.
- f I'm afraid not. Can I take a message?
- g It wasn't my fault.
- h Sorry to keep you waiting.

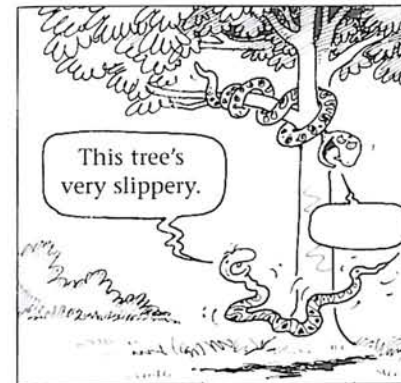
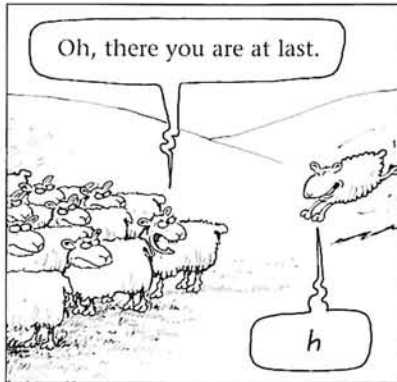

To give someone a hand and to keep an eye on someone are two examples of idioms that use parts of the body.

To elbow someone means to push past them.

*They elbowed their way to the front of the queue.*

If we can't stand something, we can say *I can't stomach it* or *I can't face it*.

Can you guess what the idiom means in this sentence?

*I listened carefully in the history lesson but I couldn't concentrate.*

*The teacher's words went in one ear and out the other.*

# 28 Compound nouns 2

A Find words in the box to complete the compound nouns. Write each compound noun.

- 1 business card, birthday card
- 2 drawing \_\_\_\_\_, safety \_\_\_\_\_
- 3 ear \_\_\_\_\_, key \_\_\_\_\_
- 4 floor \_\_\_\_\_, notice \_\_\_\_\_
- 5 laundry \_\_\_\_\_, picnic \_\_\_\_\_
- 6 pen \_\_\_\_\_, bread \_\_\_\_\_
- 7 pillow \_\_\_\_\_, brief \_\_\_\_\_
- 8 plate \_\_\_\_\_, roof \_\_\_\_\_
- 9 sleeping \_\_\_\_\_, hand \_\_\_\_\_
- 10 wall \_\_\_\_\_, news \_\_\_\_\_

- bag
- basket
- board
- card
- case
- knife
- paper
- pin
- rack
- ring

B Write the correct compound noun under each picture.



business card

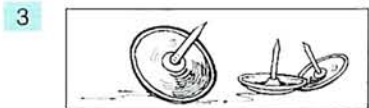

birthday card

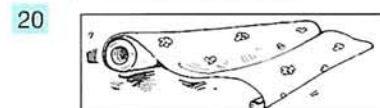
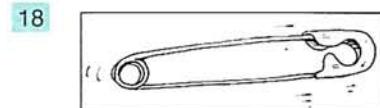
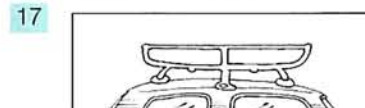
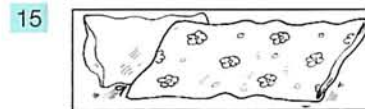
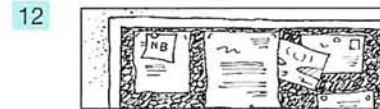
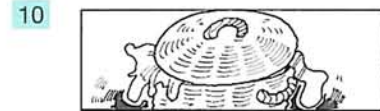
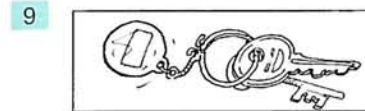
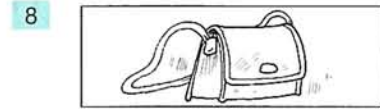
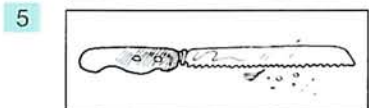



When the first noun is an *-ing* verb form, the compound noun will be written as two words, for example *steering wheel*, *watering can*, *parking meter*.

# 29 Sports and leisure equipment

Write the numbers 1 to 16 next to the correct words.

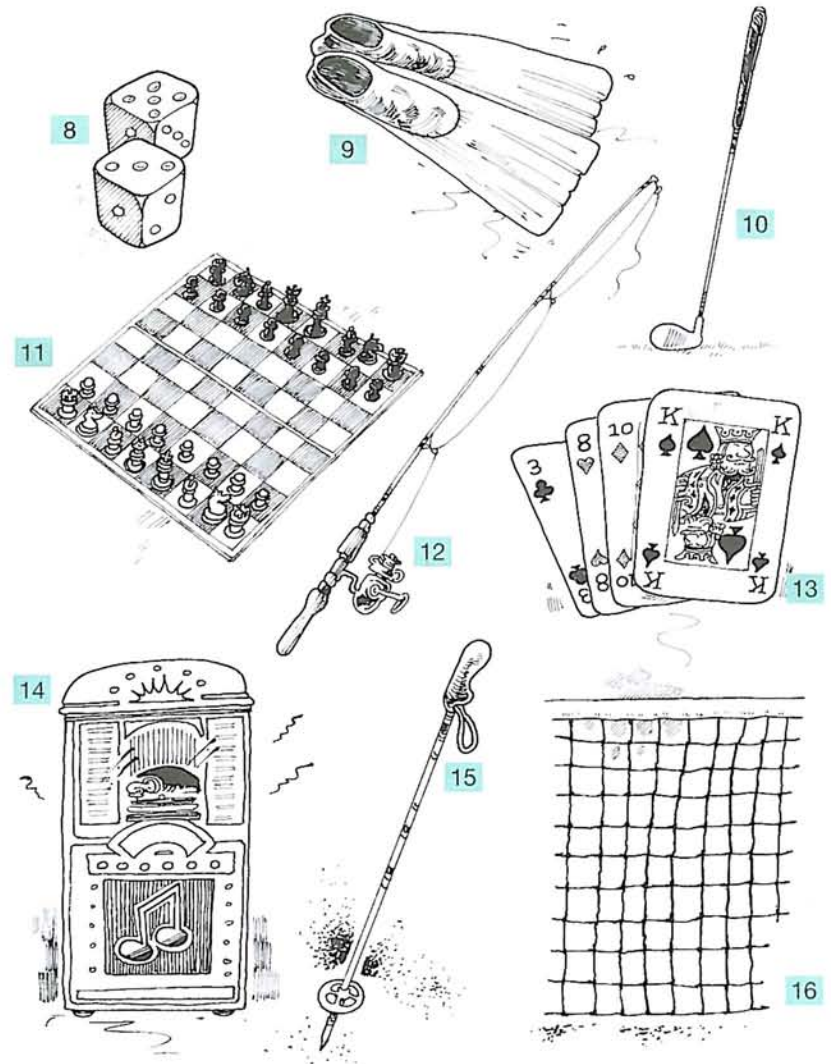
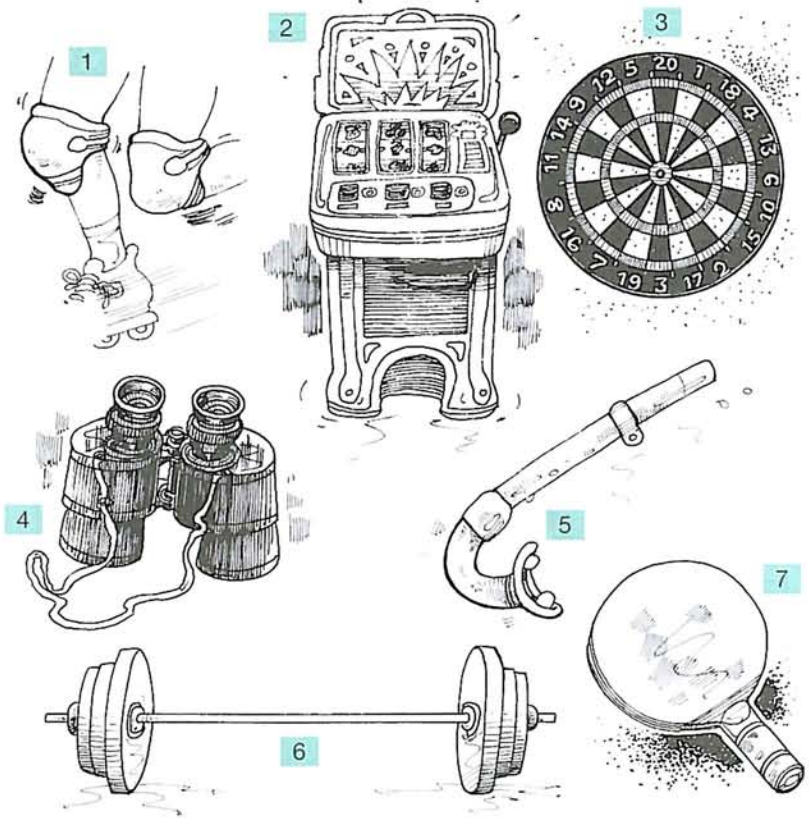
binoculars 4      fruit machine \_\_\_\_\_      playing cards \_\_\_\_\_  
 chess set \_\_\_\_\_      golf club \_\_\_\_\_      ski stick \_\_\_\_\_  
 dartboard \_\_\_\_\_      jukebox \_\_\_\_\_      snorkel \_\_\_\_\_  
 dice \_\_\_\_\_      knee pads \_\_\_\_\_      table tennis bat \_\_\_\_\_  
 fishing rod \_\_\_\_\_      net \_\_\_\_\_      weights \_\_\_\_\_  
 flippers \_\_\_\_\_



 • Another word for *table tennis* is *ping pong*.  
 Let's have a game of ping pong. Where are the ping pong balls?  
 • In American English a *fruit machine* is called a *slot machine*.

# 30 Abstract nouns

A Make abstract nouns by matching the first part of each word with the correct ending. Choose from the following: *-ment, -ance, -tion, -ence, -ship, -ity*.

- |   |           |       |    |          |       |    |          |       |
|---|-----------|-------|----|----------|-------|----|----------|-------|
| 1 | achieve   | ment  | 9  | experi   | _____ | 17 | perform  | _____ |
| 2 | agree     | _____ | 10 | experi   | _____ | 18 | possibil | _____ |
| 3 | appear    | _____ | 11 | friend   | _____ | 19 | qual     | _____ |
| 4 | communica | _____ | 12 | import   | _____ | 20 | quant    | _____ |
| 5 | confid    | _____ | 13 | informa  | _____ | 21 | relation | _____ |
| 6 | differ    | _____ | 14 | inven    | _____ | 22 | situa    | _____ |
| 7 | dist      | _____ | 15 | leader   | _____ | 23 | unemploy | _____ |
| 8 | educa     | _____ | 16 | opportun | _____ | 24 | viol     | _____ |

B Complete each sentence with one of the abstract nouns.

- 1 Congratulations! Cycling all the way around the Mediterranean is a fantastic achievement.
- 2 Don't take your children to see that film. There's a lot of sex and \_\_\_\_\_ in it.
- 3 His \_\_\_\_\_ has increased since he went on that public speaking course. He gave a talk to 200 people last week and he didn't seem at all nervous.
- 4 I have a very good \_\_\_\_\_ with my boss. We get on very well.
- 5 There is a \_\_\_\_\_ that I will be out when you get here tomorrow. If I am out, you'll find the keys under the rubbish bin in the garden.

- 6 In Biology, we did an \_\_\_\_\_ to see the importance of light for growing plants.
- 7 She's always worried about her \_\_\_\_\_. She keeps changing her hair colour and going on diets to lose weight.
- 8 She's been a teacher for fifteen years. She has a lot of \_\_\_\_\_ with children of all ages.
- 9 The two sides talked all day but they couldn't reach an \_\_\_\_\_.
- 10 I wanted to visit Josie in New York but I didn't get the \_\_\_\_\_. I had to go to meetings every day until late at night.
- 11 There is terrible \_\_\_\_\_ in this country. There are over two million people without jobs.
- 12 These shoes didn't cost much but they are really good \_\_\_\_\_. They're leather and they're handmade.
- 13 To start with, Martin was in charge. When he got ill, Jill took over the \_\_\_\_\_ of the group.
- 14 Which \_\_\_\_\_ of the twentieth century do you think has changed people's lives the most?
- 15 'What is the \_\_\_\_\_ from London to Edinburgh?'  
'I think its about 350 kilometres, but I'm not sure.'



There's a story that a student of English once spelled the word *fish* like this: *ghoti*. When asked why, she explained that the *gh* gave the sound *f* as in *rough*, the *o* gave the sound *i* as in *women*, and the *ti* gave the sound *sh* as in *station*! While it's true that English spelling is not easy, there are patterns that you can learn like the ending *-tion*, which is pronounced /ʃən/.

# 31 Verbs: world of work

Match each worker to one of the activities they do in their job. Choose a verb from box A and a noun phrase from box B.

	A	B
1 an editor <i>edits magazines</i>	adds up	an audience
2 an accountant _____	checks	cakes
3 a comedian _____	makes	essays
4 an actor _____	delivers	figures
5 a singer _____	<del>edits</del>	land
6 an art restorer _____	entertains	letters and parcels
7 a decorator _____	marks	<del>magazines</del>
8 a baker _____	measures	meals
9 a college lecturer _____	performs	old paintings
10 a doctor _____	puts up	passports and visas
11 an immigration officer _____	records	patients
12 a refuse collector _____	cleans	plays
13 a surveyor _____	serves	the rubbish
14 a waiter _____	takes away	songs
15 a courier _____	treats	wallpaper



The noun *refuse* is pronounced differently from the verb *refuse*.

**refuse**, with the stress on the first syllable = rubbish

**refuse**, with the stress on the second syllable = say 'no' to something

# 32 Filling in forms

Complete the form with the correct words from the box.

birth capitals code ~~complete~~ forenames ink length  
nationality occupation permanent purpose sex signature  
status surname telephone temporary title

## PRESTON PARK STUDENT HEALTH CENTRE

Please (1) complete this form in BLOCK (2) \_\_\_\_\_ in blue or black (3) \_\_\_\_\_.

(4) \_\_\_\_\_ : Mongiovi

(5) \_\_\_\_\_ : Maria Liliana

Date of (6) \_\_\_\_\_ : 11.11.75

(7) \_\_\_\_\_ : Female / ~~Male~~

(8) \_\_\_\_\_ : ~~Mr / Mrs / Miss / Ms / Dr~~

Marital (9) \_\_\_\_\_ : ~~Single / Married / Divorced~~

(10) \_\_\_\_\_ : Italian

(11) \_\_\_\_\_ : journalist

(12) \_\_\_\_\_ of visit: To study English at the Preston Park Language Centre

(13) \_\_\_\_\_ address: via Rosalia, 35, 90143 Palermo, Italy

(14) \_\_\_\_\_ address: 15 College Court Road, Brighton, Sussex

Post (15) \_\_\_\_\_ : BN1 6UZ

(16) \_\_\_\_\_ : 01273 487459

(17) \_\_\_\_\_ of visit: 1 MONTH

(18) \_\_\_\_\_ : Maria L. Mongiovi

Date: 15th August 2001



Official forms often state that they should be completed in blue or black ink. This does not mean that we have to use a fountain pen with ink in it. It just means that we must not use a pencil.



# 33 Adjectives: things

A Put the adjectives into the correct category in the table.

beige bitter boiling cool cream furry gigantic  
 humid juicy massive minute navy oval rectangular  
 ripe rough smooth triangular

Colour <i>beige</i> _____ _____ _____	Shape _____ _____ _____	Size _____ _____ _____
Describing food _____ _____ _____	Describing weather _____ _____ _____	Texture _____ _____ _____

B Complete the sentences with the correct adjectives from the table above.

- 1 Don't pick those apples. They aren't \_\_\_\_\_ yet.
- 2 I always shave my legs in the summer. I like them to be nice and \_\_\_\_\_ when I go to the beach.
- 3 The temperature isn't that high but it's very \_\_\_\_\_ today. You start sweating as soon as you go outside.
- 4 I'm not thirsty. I just ate a really \_\_\_\_\_ orange.
- 5 Dark blue doesn't suit me so I don't look very nice in my uniform, which is \_\_\_\_\_ and grey.
- 6 I can't read the print in that dictionary. It's \_\_\_\_\_.
- 7 I gave my niece a big brown \_\_\_\_\_ teddy bear for her birthday.

- 8 Cats have \_\_\_\_\_ faces with the ears and the chin as the three points.
- 9 It's \_\_\_\_\_ here in the summer. We spend all day relaxing in the pool.
- 10 Our dining room table isn't exactly round. It's more \_\_\_\_\_.



There is a rule for the order of adjectives when several are used together.

opinion	size	age	style	colour	origin	material	purpose	noun
horrible	little			white				dog
lovely	short		curly	blonde				hair
beautiful	long			black		silk	party	dress
nice		old			French		soup	bowls

*I was bitten by a horrible little white dog.  
 Who's that girl with the lovely short curly blonde hair?  
 She was wearing a beautiful long black silk party dress.  
 Where did you get those nice old French soup bowls?*

# 34 Disasters

Complete the extracts from newspaper articles with the correct words from the box. Put the verbs in the correct form.

crash (verb) disease drought drown (verb) earthquake famine-  
flood hijack hurricane kidnap (verb) lightning volcano

1 Thousands of children are dying of hunger in Ethiopia. The Red Cross is distributing food in the worst areas of the famine but ...

2 The area around Boulder, Colorado, has not seen rain for nine months. During the long \_\_\_\_\_, water supplies have been brought in by lorry ...

3 A 53-year-old policeman \_\_\_\_\_ in the River Thames at Hammersmith, West London, last night. The man, Robert Fox, dived in to rescue his granddaughter ...

4 A massive \_\_\_\_\_ shook Los Angeles yesterday, destroying hundreds of buildings and a road bridge. It measured 7.2 on the Richter Scale ...

5 A twenty-eight-year-old mother of two was in hospital last night after she was struck by \_\_\_\_\_. The woman has slight burns on her arm. 'I was taking the dogs for a walk in the park when the storm started ...'

6 The \_\_\_\_\_ of the International Airlines plane ended last night when the terrorists released all the passengers and gave themselves up to the police.

7 Doctors have no cure for the mystery \_\_\_\_\_ which is spreading across northern India. Symptoms are sore fingers and toes and a fever.

8 Scientists say that Mount Etna will erupt in the next few days. Thick smoke started to pour from the \_\_\_\_\_ this morning and ...

9 Residents of Lewes, in East Sussex, had to swim across the main street yesterday. The \_\_\_\_\_ caused by recent heavy rain is the worst for 150 years.

10 A coach full of schoolchildren \_\_\_\_\_ on the M4 motorway last night. The driver and two children were taken to hospital suffering from cuts.

11 The 12-year-old son of a wealthy businessman was \_\_\_\_\_ in New York last night. Mr Tony Brancusi, the child's father, told journalists he had received a letter asking for \$2 million for the return of his son.

12 A \_\_\_\_\_ in the Caribbean island of Nevis has killed fourteen people and left thousands homeless. 'The wind blew the roof off my house,' one survivor said.



Motorways in Britain are called *M* (for motorway) and a number, for example *M1*, *M4*, *M25*.

We use the definite article to refer to a motorway.

*We were driving up the M40 on our way to Birmingham, when our car broke down.*

# 35 Parts of a car

Write the numbers 1 to 18 next to the correct words.

- |                  |                    |                         |
|------------------|--------------------|-------------------------|
| aerial <u>12</u> | hand brake _____   | speedometer _____       |
| bonnet _____     | indicator _____    | steering wheel _____    |
| boot _____       | mirror _____       | tyre _____              |
| bumper _____     | number plate _____ | wheel _____             |
| engine _____     | petrol cap _____   | windscreen _____        |
| gear stick _____ | seatbelt _____     | windscreen wipers _____ |

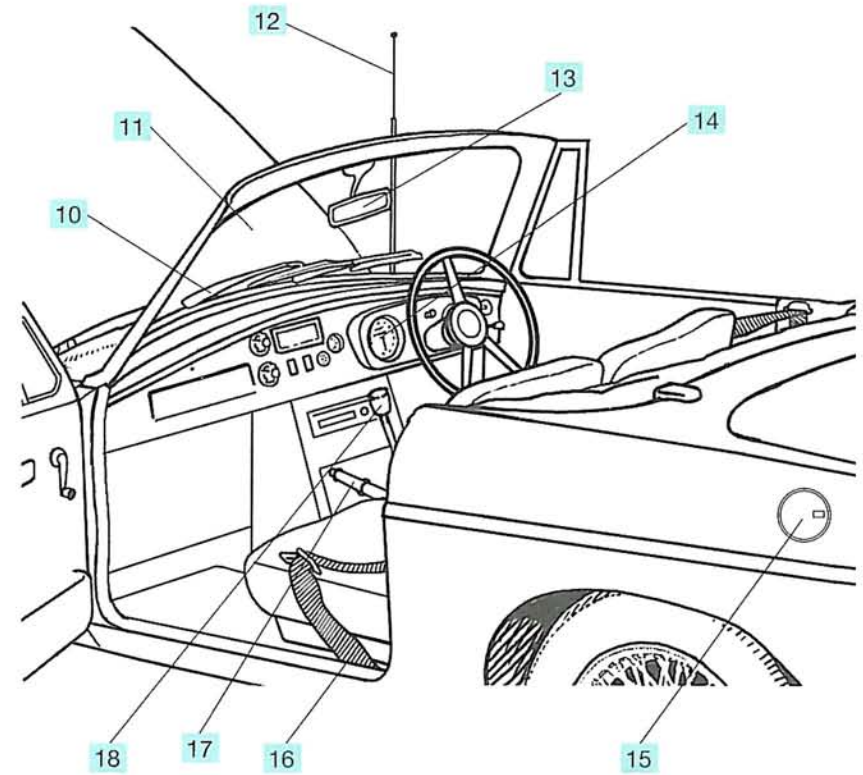
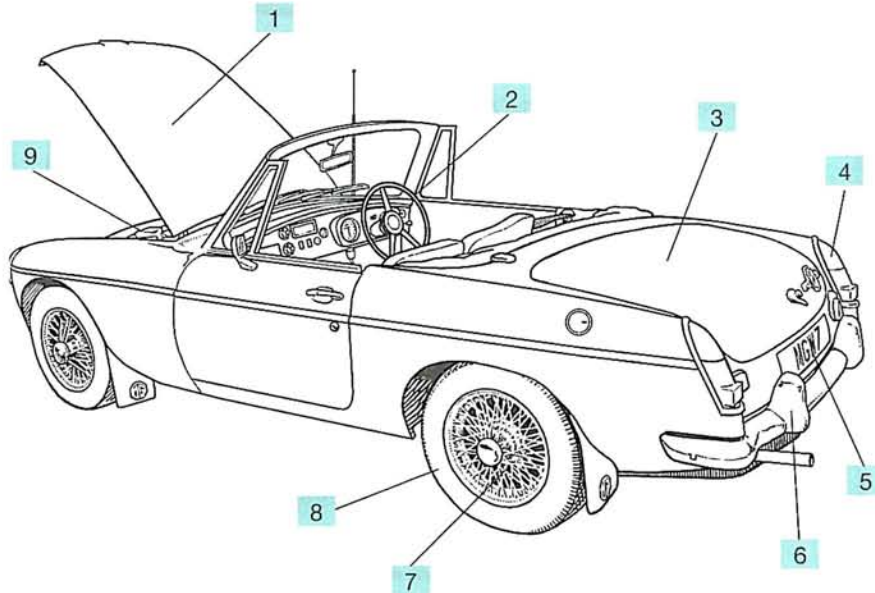

There are a number of differences in British and American English for the parts of a car. Here are some of them:

British English	American English
<i>bonnet</i>	<i>hood</i>
<i>boot</i>	<i>trunk</i>
<i>number plate</i>	<i>license plate</i>
<i>bumper</i>	<i>fender</i>

# 36 Prepositions 1

Complete the sentences with the missing words.

- 1 I'm very disappointed in him. I thought he was a reliable person.  
a) on                      **b) in**                      c) about
- 2 We had some difficulty \_\_\_\_\_ persuading her to come with us.  
a) in                      b) for                      c) to
- 3 She's very self-conscious \_\_\_\_\_ her height. She thinks she's too tall.  
a) after                      b) for                      c) about
- 4 I think we should divide all the leftover drinks and food from the party \_\_\_\_\_ ourselves.  
a) with                      b) for                      c) among
- 5 His ideas about education differ quite a lot \_\_\_\_\_ mine.  
a) to                      b) from                      c) with
- 6 Be careful! There are a lot of exceptions \_\_\_\_\_ this spelling rule.  
a) of                      b) for                      c) to
- 7 I think this song was inspired \_\_\_\_\_ an old Beatles one.  
a) by                      b) of                      c) from
- 8 This is entirely \_\_\_\_\_ you and me, but I think they're going to split up soon.  
a) among                      b) between                      c) for
- 9 Apparently Suzie's reading is \_\_\_\_\_ average. In fact, she's one of the brightest in her year.  
a) above                      b) over                      c) in front of
- 10 If we put the ladder \_\_\_\_\_ that wall, I'll be able to get on to the roof.  
a) under                      b) beside                      c) against
- 11 What are you holding \_\_\_\_\_ your back? Is it a present for me?  
a) behind                      b) under                      c) towards
- 12 We saw some horrible boys throwing stones \_\_\_\_\_ a poor old dog.  
a) for                      b) against                      c) at





Test 43 on pages 78–79 gives more practice of the use of prepositions.

# 37 Physical appearance

Write the numbers 1 to 17 next to the correct words.

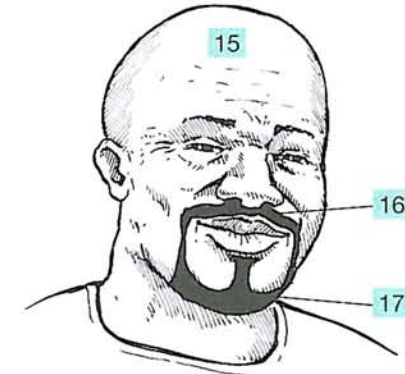
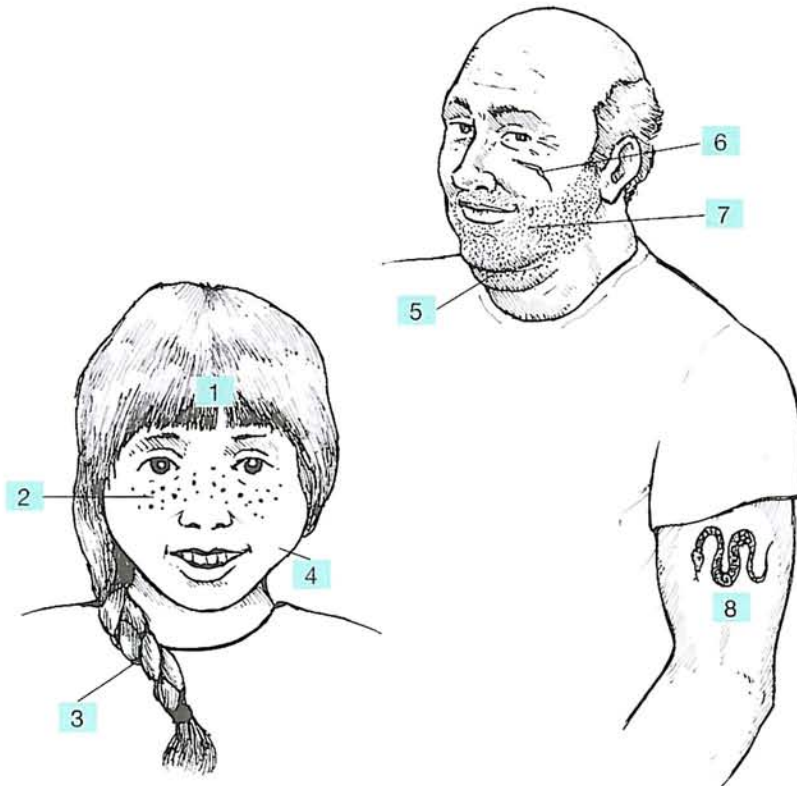
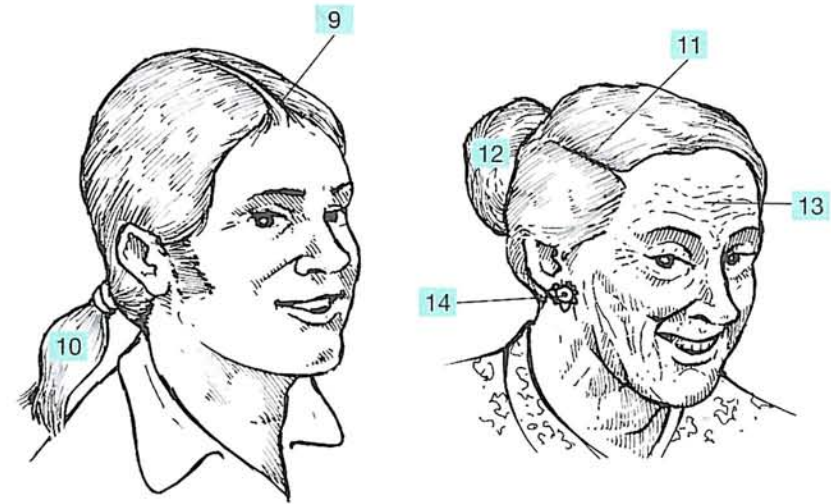
- |                     |                      |                    |
|---------------------|----------------------|--------------------|
| bald <u>15</u>      | freckles _____       | scar _____         |
| beard _____         | fringe _____         | side-parting _____ |
| bun _____           | middle-parting _____ | stubble _____      |
| chubby cheeks _____ | moustache _____      | tattoo _____       |
| double chin _____   | plait _____          | wrinkles _____     |
| earring _____       | pony tail _____      |                    |



 In American English, a *plait* is called a *braid* and a *fringe* is *bangs*.  
Who's the little girl with the braid and bangs?

# 38 Verbs: mostly in the mind

Complete the sentences below with the correct form of the words in the box.

admire allow compare confuse deserve disapprove  
intend pretend prove recognize solve suppose  
tease terrify trust wish

- 1 You aren't allowed to park here. Can't you see the sign?
- 2 She lent him the money because she \_\_\_\_\_ him to repay it. She didn't realize he was totally dishonest.
- 3 Don't tell the children ghost stories just before bed. You'll \_\_\_\_\_ them.
- 4 I \_\_\_\_\_ you'd give me some advice. Please tell me what to do.
- 5 I didn't want to go to the party so I \_\_\_\_\_ to have a headache.
- 6 I hadn't seen her for twenty years but I \_\_\_\_\_ her immediately.
- 7 I really \_\_\_\_\_ of people who always drive when they could walk. It's so bad for the environment.
- 8 I was \_\_\_\_\_ to finish this project last week but I don't think I'll finish it for another two weeks.
- 9 Money will \_\_\_\_\_ some of your problems but not all of them.
- 10 I want to \_\_\_\_\_ the prices of a few computers before I buy one.

- 11 People always \_\_\_\_\_ me and my sister because we are quite similar.
- 12 Adam is in love with Martina but he has never told her how much he \_\_\_\_\_ her.
- 13 Statistics \_\_\_\_\_ that women are better drivers than men. They have fewer accidents.
- 14 They \_\_\_\_\_ to leave at six in the morning but they didn't get going until eleven.
- 15 My friends always used to \_\_\_\_\_ me about my terrible voice. That's why I only sing in the bath now.
- 16 You've been working hard all week. I think you \_\_\_\_\_ a rest this weekend.



**Librarian:** No talking allowed in this library.

**Schoolchildren:** But we aren't talking aloud. We're whispering.

# 39 British and American English

How do Americans say these words? Choose from the words in the box.

## American English

apartment   cab   ~~chips~~   clerk   deck   downtown  
drugstore   elevator   faucet   parking lot   restroom  
round trip   sidewalk   stand in line   subway   trash

- 1 Can you buy some **crisps** for the picnic?  
(American English:     *chips*    )
- 2 Don't leave **rubbish** in the park. Take your empty drinks cans home with you.  
(American English:                     )
- 3 Excuse me, where's the nearest **toilet**, please?  
(American English:                     )
- 4 He works as a sales **assistant** in a big department store.  
(American English:                     )
- 5 I can't walk any further. Let's take a **taxi**.  
(American English:                     )
- 6 I have to go to the **chemist's** to buy some film for my camera.  
(American English:                     )
- 7 I'd like a **return ticket** to Bristol, please.  
(American English:                     )
- 8 It's quicker to go there by **underground** than by bus.  
(American English:                     )

- 9 Take the **lift** to the fourteenth floor.  
(American English:                     )
- 10 There's something wrong with the hot water **tap**. I can't turn it off.  
(American English:                     )
- 11 We can leave the car in the **car park** behind the supermarket.  
(American English:                     )
- 12 We could play a game of poker if someone has a **pack** of cards.  
(American English:                     )
- 13 We had to **queue** for an hour to get tickets for the latest James Bond film.  
(American English:                     )
- 14 You shouldn't cycle on the **pavement**. It's dangerous for the people who are walking.  
(American English:                     )
- 15 She lives in a modern **flat** near the university.  
(American English:                     )
- 16 I work in a bank **in the city centre**.  
(American English:                     )



There are some possibilities for confusion when British and American people talk about food.

British English	American English
<i>crisps</i>	<i>chips</i>
<i>chips</i>	<i>French fries</i>

# 40 Cartoons 2

Match the words to the pictures. Write the letters a) to h) in the balloons.

- a Can you please sit still and stop biting your nails.
- b He's always been a bad loser.
- c I wish I hadn't already had lunch.
- d I'm sure we took a wrong turning somewhere.
- e Keep in touch.
- f Now what's all the fuss about?
- g Stand clear of the doors.
- h We're going clubbing.

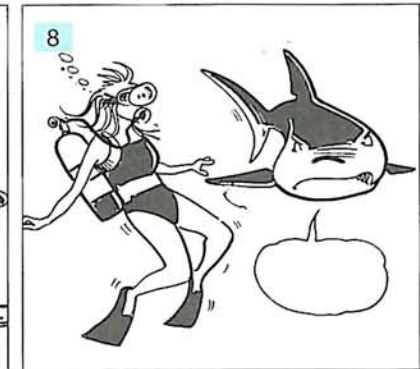
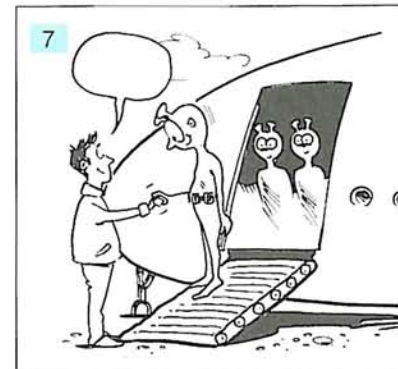
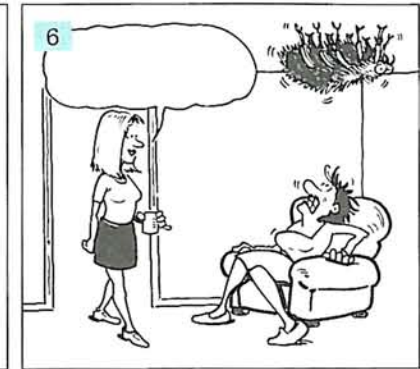
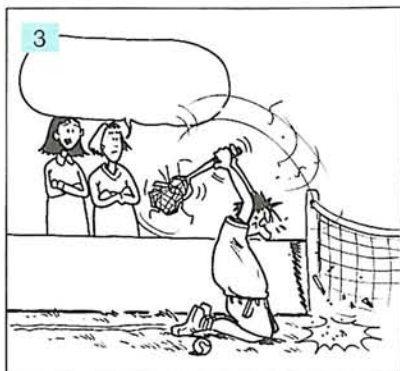
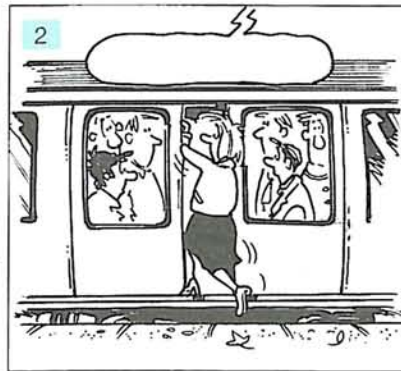

On the London Underground, just before the train doors shut, there is an announcement on loud speakers: *'Stand clear of the doors. This train is about to depart.'*

Very often, when the train arrives at a station, there is an announcement inside the train: *'Mind the gap.'* This is a warning for passengers getting off the train, about the gap between the train door and the edge of the platform.



# 41 Confusing words

Underline the correct word in each of the following sentences.

- 1 Was it Alexander Bell who (*invented* / *discovered*) the telephone?
- 2 The injured man was (*laying* / *lying*) on the road close to the crashed cars.
- 3 Amsterdam is a city full of (*channels* / *canals*).
- 4 Would you (*check* / *control*) these figures, Mr Brown, just to make sure they're correct?
- 5 The (*nature* / *countryside*) around this town is very flat and uninteresting.
- 6 Could I have a (*recipe* / *receipt*) for the things I've bought?
- 7 Oh, Jan, could you (*remember* / *remind*) me to phone the doctor this afternoon?
- 8 I wonder if you'd mind (*bringing* / *fetching*) John from next door? He's wanted on the phone.
- 9 What (*more* / *else*) did you do in Spain, apart from swimming and sunbathing?
- 10 Have you made (*an appointment* / *a meeting*) to see the bank manager yet?
- 11 I'll have to change this jacket. I bought it to go with my blue trousers, but it doesn't (*suit* / *match*) them after all.

- 12 I've got no money at all. I'm completely (*broken* / *broke*).
- 13 He really works hard. He's so (*industrious* / *industrial*).
- 14 Why don't you (*take* / *bring*) your girlfriend next time? We'd love to meet her.
- 15 She's very (*superstitious* / *supernatural*). She never walks under ladders and she doesn't dare go out of the house on Friday 13th.



One way of sorting out the correct use and meaning of pairs of words that you find confusing is to write pairs of sentences using each of the words. When you have finished this test, try writing sentences with each of the 'wrong' words. For example, sentence 1 above illustrates the use of *invented*. Here is a sentence showing the use of *discovered*:  
*Marie Curie discovered two new elements: radium and polonium.*

# 42 Verbs: opposites

A Match each verb on the left to its opposite in the box on the right.

- 1 accept refuse
- 2 adore \_\_\_\_\_
- 3 attack \_\_\_\_\_
- 4 create \_\_\_\_\_
- 5 encourage \_\_\_\_\_
- 6 get worse \_\_\_\_\_
- 7 increase \_\_\_\_\_
- 8 obey \_\_\_\_\_
- 9 praise \_\_\_\_\_
- 10 vanish \_\_\_\_\_

- appear
- criticize
- decrease
- defend
- destroy
- discourage
- disobey
- improve
- loathe
- ~~refuse~~

B Complete the sentences with the correct form of the verbs above.

- 1 Everybody was against him at the meeting. Nobody tried to \_\_\_\_\_ him.
- 2 Her French has \_\_\_\_\_ a lot since she started having private lessons.
- 3 I absolutely \_\_\_\_\_ him and I'll never speak to him again. He's a cheat and a liar.
- 4 I got the part in the film thanks to Sandra. She's the one who \_\_\_\_\_ me to try for it.
- 5 I was following Jake through the forest when suddenly he \_\_\_\_\_ and I couldn't find him.
- 6 It's a fantastic book. All the reviews have \_\_\_\_\_ it.
- 7 We offered to lend him the money but he didn't \_\_\_\_\_ it.

- 8 She's got a really naughty puppy. It never \_\_\_\_\_ her when she tells it to sit.
- 9 The fire completely \_\_\_\_\_ the building. Only one wall was left standing.
- 10 The man jumped out of the bushes and \_\_\_\_\_ me with a knife. It was terrifying.
- 11 The rent on my flat has \_\_\_\_\_ by 20% this year so I won't be able to afford a holiday.
- 12 We always leave a light on in the house when we go out to \_\_\_\_\_ burglars from breaking in.



- The opposite of many verbs is formed with the prefix *dis-*, for example *obey / disobey, encourage / discourage, agree / disagree, prove / disprove, trust / distrust, approve / disapprove, appear / disappear*.
- The prefix *de-* sometimes means *to make less*, for example *decrease, devalue, depopulate, deforest*.

# 43 Prepositions 2

Complete the sentences with the missing words.

- 1 Those pills had a strange effect on me. I won't take them again.  
a) for                      b) by                      c) **on**
- 
- 2 I can't see any reason \_\_\_\_\_ this price rise.  
a) of                      b) for                      c) to
- 
- 3 We noticed a huge bird \_\_\_\_\_ the distance.  
a) in                      b) at                      c) along
- 
- 4 Children \_\_\_\_\_ twelve pay half price for entrance tickets.  
a) below                      b) under                      c) before
- 
- 5 Please come away \_\_\_\_\_ the edge of the cliff. You're making me nervous.  
a) of                      b) back                      c) from
- 
- 6 She's agreed to swap \_\_\_\_\_ me and do the Saturday shift.  
a) for                      b) with                      c) from
- 
- 7 My grandfather died \_\_\_\_\_ a heart attack.  
a) by                      b) with                      c) of
- 
- 8 How can I protect my plants \_\_\_\_\_ the snails?  
a) from                      b) for                      c) of

- 9 Have you seen that new advertisement \_\_\_\_\_ jeans?  
a) about                      b) for                      c) on
- 
- 10 He won't admit \_\_\_\_\_ being a bad driver although he's had three crashes.  
a) for                      b) about                      c) to
- 
- 11 She was given a reward \_\_\_\_\_ her courage during the rescue operation.  
a) for                      b) about                      c) of
- 
- 12 We're trying to work out the cause \_\_\_\_\_ the fire.  
a) of                      b) for                      c) to



Prepositions are the hardest words to translate. How would you translate *on* into your language in the following sentences? Can you use the same word in your language for each of them?

*There's a lot of traffic on the road today.*

*We met on the last day of the holidays.*

*They went on foot.*

*It had a strange effect on her.*

That's why it's best to learn new prepositions in a whole sentence. Don't try to learn them as single words.

# 44 Types of transport

Write the numbers 1 to 18 next to the correct words.

- |                    |                  |                  |
|--------------------|------------------|------------------|
| ambulance <u>4</u> | ferry _____      | scooter _____    |
| bus _____          | helicopter _____ | sports car _____ |
| canoe _____        | lorry _____      | submarine _____  |
| caravan _____      | motorbike _____  | tractor _____    |
| coach _____        | plane _____      | van _____        |
| estate car _____   | rocket _____     | yacht _____      |

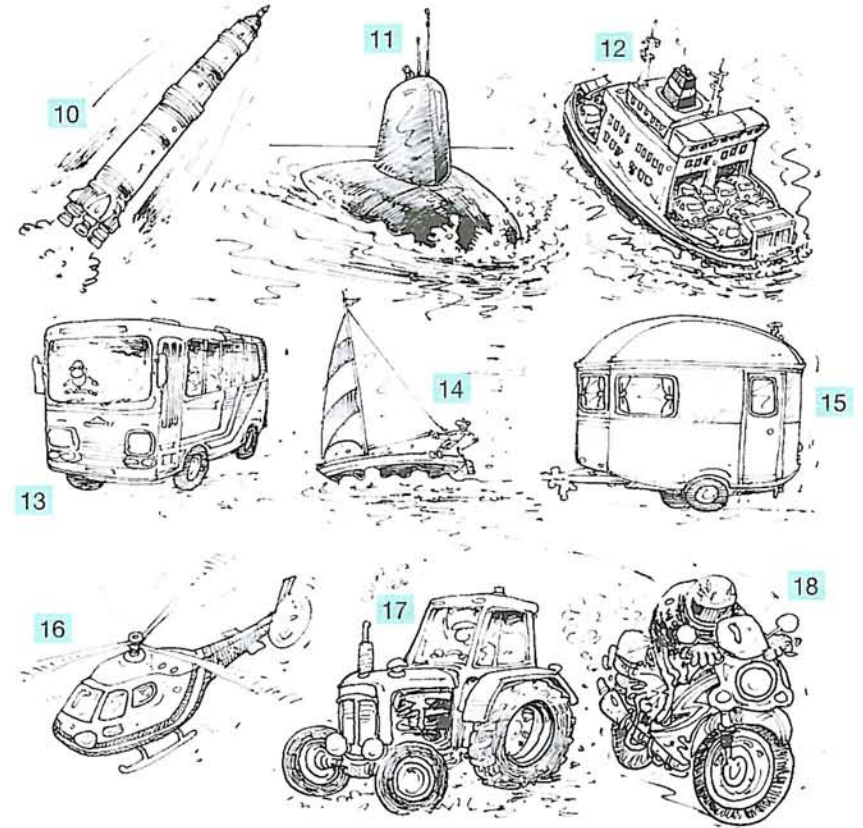
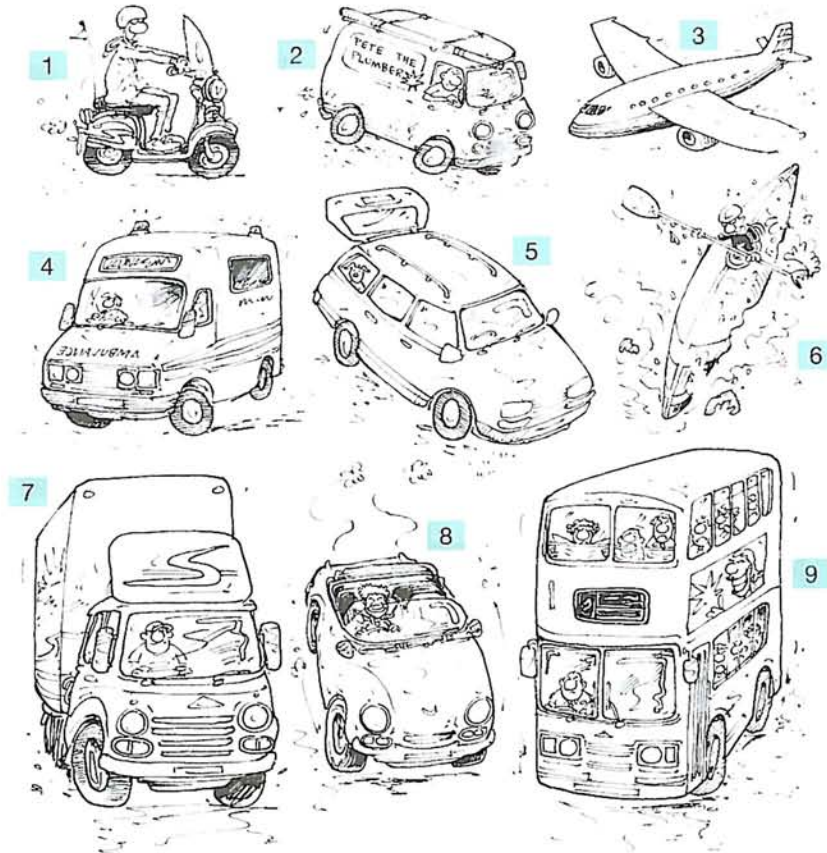

- In British English we say *lorry*. In American English, the word is *truck*.
- The word *scooter* has two meanings:



It is a type of motorbike.



This is also called a scooter.

# 45 Adjectives: synonyms

In each sentence give a synonym for the words in brackets. Choose from the following:

absurd   anxious   attractive   cheerful   coarse   confident  
immature   intentional   ~~mad~~   pathetic   relaxed   reliable  
                  revolting   starving   weird

- 1 There's only one way of describing her. She is completely (*crazy*) mad.
- 2 A good friend is someone who is kind, considerate and totally (*dependable*) \_\_\_\_\_.
- 3 I wish you'd grow up! You're so (*childish*) \_\_\_\_\_.
- 4 I didn't mean to break it – it wasn't (*deliberate*) \_\_\_\_\_.
- 5 The food at the hotel was really (*disgusting*) \_\_\_\_\_. No one could eat it.
- 6 Her hands are very (*rough*) \_\_\_\_\_ because she spends most of her time working in the garden.
- 7 I could eat a horse! I'm (*really hungry*) \_\_\_\_\_.
- 8 Take those trousers off – you look (*ridiculous*) \_\_\_\_\_ in them!
- 9 We lost 6–1! You played like you were half-asleep! You were (*hopeless*) \_\_\_\_\_!
- 10 Charles has some really (*strange*) \_\_\_\_\_ ideas sometimes, doesn't he?

- 11 He's really (*good-looking*) \_\_\_\_\_. All the girls fancy him.
- 12 She's always (*worried*) \_\_\_\_\_ about something even when things are going well.
- 13 It's fun to be with him because he's so (*light hearted*) \_\_\_\_\_. With him, life always seems easy.
- 14 He's always totally (*calm*) \_\_\_\_\_. I don't think he knows the meaning of the word stress.
- 15 Try to be more (*sure of yourself*) \_\_\_\_\_ when you get on the horse. It will know if you are feeling nervous.



Usually words don't have identical uses even if their meanings are very similar. One word may be more formal than the other, or there may be a shade of difference in meaning. For example, *crazy*, *mad*, *insane*, all have the same meaning. However, *crazy* is more informal than the other two words. *Insane* is the most formal of the three. The words *crazy* and *mad* can both be used to mean *angry*.

# 46 Phrasal verbs 2

Complete each sentence with a phrasal verb in the correct tense. Sometimes you will have to separate the verb from the particle.

break up   call off   drop out   get by   get out of   go off  
go on   hold up   ~~put up~~   take up   turn down   work out

- 1 Diane phoned and asked if we could put her up for the night. (*give her a bed*)
- 2 Ed and Liz have \_\_\_\_\_. Liz is going out with Colin now. (*separated*)
- 3 He says he's sick of photography and he's going to \_\_\_\_\_ painting now instead. (*start*)
- 4 He was doing a degree at Harvard but he \_\_\_\_\_ after failing one of his exams. (*gave up and left*)
- 5 I didn't want to go to dinner with them but there was no way I could \_\_\_\_\_ it. (*find an excuse not to go to*)
- 6 I'm not very good at Spanish but I \_\_\_\_\_ when I was in Chile last year. (*managed to communicate*)
- 7 Marina was offered an amazing job in New York but she \_\_\_\_\_ it \_\_\_\_\_ because she wanted to stay in Boston. (*didn't accept*)
- 8 Our flight was \_\_\_\_\_ for three hours by bad weather. (*delayed*)
- 9 She \_\_\_\_\_ asking me questions until in the end I had to tell her the truth. (*didn't stop*)

- 10 She used to love scuba diving but she \_\_\_\_\_ it after her boyfriend got attacked by a shark. (*lost her enthusiasm for*)
- 11 The hotel staff had lost our booking and we had to stay somewhere else. But in the end everything \_\_\_\_\_ and we had a great time. (*came right*)
- 12 They've decided to \_\_\_\_\_ the barbecue because the weather is so bad. (*cancel*)



With many phrasal verbs, when the direct object is a noun, the noun can go before or after the particle: *We're putting up some friends for the night*, OR *We're putting some friends up for the night*. If the direct object of these phrasal verbs is a pronoun, the pronoun has to go before the particle: *We're putting them up for the night*. NOT ~~*We're putting up them for the night*~~.

# 47 Things to read

Complete the sentences with the correct words from the box.

album atlas brochure calendar catalogue comic diary  
dictionary directory encyclopedia index manual map  
~~newspaper~~ recipe book register romantic novel timetable

- 1 You read a newspaper to find out what has happened recently in your own country and in the rest of the world.
- 2 In a \_\_\_\_\_ you find a list of things for sale, usually with photos, plus their prices.
- 3 An \_\_\_\_\_ shows you where towns, rivers and mountains are in all the countries of the world.
- 4 A \_\_\_\_\_ is a love story.
- 5 An \_\_\_\_\_ is a book, or a set of books, with information on many different subjects in alphabetical order.
- 6 You can keep a collection of photographs or autographs in an \_\_\_\_\_.
- 7 You look at a \_\_\_\_\_ to know the date and the month.
- 8 You can use a \_\_\_\_\_ to write down important dates of meetings, for example. You can also use one to keep a record of what happens in your life.
- 9 An \_\_\_\_\_ is an alphabetical list of names or subjects at the back of a book. It gives the pages where you can find each of these names or subjects.

- 10 If you have a \_\_\_\_\_ then you shouldn't get lost.
- 11 When something goes wrong with your computer, you can always try to fix it yourself with the help of the \_\_\_\_\_.
- 12 If you want to find out the times of trains or buses, you should look at a \_\_\_\_\_.
- 13 A lot of people choose where to go for a holiday by looking at the pictures in a tourist \_\_\_\_\_.
- 14 If you want to find out how to make a particular dish, you can look in a \_\_\_\_\_.
- 15 If you don't know a person's telephone number, you can look it up in the telephone \_\_\_\_\_.
- 16 You look up words in a \_\_\_\_\_ to find out their meaning.
- 17 A \_\_\_\_\_ is a magazine with picture stories. Speech balloons from the people in the pictures show what the people are saying or thinking.
- 18 A teacher uses a \_\_\_\_\_ to record how often each student comes to a class.



Sometimes it's easier to learn new words working with a friend. After you've done this test once, write the eighteen new words on small pieces of paper. Take turns picking a piece of paper and using the word on it in a sentence.

# 48 Classifications

Complete each group of words below with a word from the box. Then write the name for each group in the grid on page 89.

bear boots burglary brochure carton darts  
deodorant earrings flood from jazz knickers  
mascara ostrich ~~plastic~~ sardine silk van well wet

- 1 wood, metal, glass, plastic
- 2 slowly, better, softly, \_\_\_\_\_
- 3 necklace, chain, bracelet, \_\_\_\_\_
- 4 near, behind, under, \_\_\_\_\_
- 5 mugging, shoplifting, drug-dealing, \_\_\_\_\_
- 6 rap, classical, folk, \_\_\_\_\_
- 7 chess, cards, pool, \_\_\_\_\_
- 8 cotton, nylon, wool, \_\_\_\_\_
- 9 raw, sticky, disgusting, \_\_\_\_\_
- 10 salmon, tuna, shark, \_\_\_\_\_
- 11 penguin, parrot, pigeon, \_\_\_\_\_
- 12 seal, whale, bat, \_\_\_\_\_
- 13 bra, pants, vest, \_\_\_\_\_
- 14 tin, tub, box, \_\_\_\_\_
- 15 shampoo, soap, bubble bath, \_\_\_\_\_
- 16 blusher, lipstick, powder, \_\_\_\_\_
- 17 sandals, slippers, shoes, \_\_\_\_\_
- 18 manual, catalogue, atlas, \_\_\_\_\_
- 19 coach, lorry, scooter, \_\_\_\_\_
- 20 earthquake, hurricane, drought, \_\_\_\_\_

1	M	A	T	E	R	I	A	L	S										
2			V																
3			W								Y								
4		R		P								O							
5		R																	
6			S																
7	G																		
8		L		T															
9			J			T													
10		I																	
11			R																
12			M	M															
13			D		R														
14	C			T								R							
15		O		L		T													
16			K																
17	F				W														
18	P		B			C													
19			H		C														
20		I				T													



People usually find it easier to learn new words in a set. Try adding one more word to each of the sets on this page.



# 49 Homophones

Homophones are words that sound the same but are spelt differently. What are the missing homophones in these pairs of sentences?

- 1 I'm going on a diet. I've put on a lot of weight.  
Please wait a minute. I won't be long.
- 2 I put on the \_\_\_\_\_ and the car stopped just in time.  
This kind of china \_\_\_\_\_ very easily. Be careful.
- 3 Would you like another \_\_\_\_\_ of cake with your tea?  
Everyone wanted the war to end and \_\_\_\_\_ to begin.
- 4 Can you untie the \_\_\_\_\_ in this string?  
I'm \_\_\_\_\_ very good at science. I'm better at languages.
- 5 I didn't tell her what was in the parcel. She \_\_\_\_\_ by feeling it.  
She was a \_\_\_\_\_ at a wedding I went to recently.
- 6 'Anyone who \_\_\_\_\_ gum in class will be sent out.'  
I don't know what to \_\_\_\_\_ on this menu. There are so many good things.
- 7 You aren't \_\_\_\_\_ to smoke anywhere in this building.  
Sorry, I wasn't talking to anyone in particular. I was just thinking \_\_\_\_\_.
- 8 Are you \_\_\_\_\_ you want to go out in this horrible weather?  
Yes, I'd like to go to the beach and walk along the sea \_\_\_\_\_.
- 9 That man always \_\_\_\_\_ at me when I go past his shop. I don't like it.  
Don't let's take the lift. I want to walk up the \_\_\_\_\_.

- 10 I've never jumped \_\_\_\_\_ than that. It's my personal record.  
Where can I \_\_\_\_\_ ski boots? I don't have any of my own.
- 11 There were only ten \_\_\_\_\_ of seats in the hall so quite a lot of people had to stand.  
He gave me a single red \_\_\_\_\_ on Valentine's Day.
- 12 Don't park there. It's illegal and you might get \_\_\_\_\_.  
Where is my wallet? I can't \_\_\_\_\_ it anywhere.
- 13 Get me a needle and I'll \_\_\_\_\_ this button on for you.  
She didn't pay me back the money last time \_\_\_\_\_ I refused to lend her any next time she asked.
- 14 I've had this teddy \_\_\_\_\_ since I was three.  
We haven't yet bought any carpets for our flat. We've got \_\_\_\_\_ floorboards.
- 15 They've \_\_\_\_\_ the thieves who broke into our car.  
I've got to go to \_\_\_\_\_ in three weeks to be a witness.



Lots of silly jokes in English are based on words that sound the same but are spelt differently and have different meanings. Here's one of them:

**Question:** Why are people who work in a fish shop mean?

**Answer:** Their job makes them sell fish. (*selfish*)

# 50 Verbs: synonyms

A Match each verb on the left to the one on the right that is closest to it in meaning.

1	arrange	<u>organize</u>	cheat
2	bend	_____	contain
3	lower	_____	curve
4	exchange	_____	manage
5	include	_____	<del>organize</del>
6	lie	_____	realize
7	notice	_____	reduce
8	save	_____	rescue
9	spoil	_____	ruin
10	succeed	_____	swap

B Complete the sentences with the correct forms of the verbs above. If both verbs in a pair can go in the sentence, write them both.

- Be careful! Very soon the road bends/curves round to the right.
- \_\_\_\_\_ down and touch your toes.
- Have you \_\_\_\_\_ anything different about her? She's wearing contact lenses instead of glasses.
- I am going to \_\_\_\_\_ a leaving party for them before they move to Australia.
- He never tells the truth. In fact, he \_\_\_\_\_ all the time.
- I'm going to take these shoes back to the shop and \_\_\_\_\_ them for a navy pair.
- I'm not playing with him again. He always \_\_\_\_\_ by looking at other people's cards.

- I've spent three hours trying to fix the car and all I've \_\_\_\_\_ in doing is getting my hands dirty.
- She's a hero. My son was drowning and she dived in and \_\_\_\_\_ him.
- This bill does not \_\_\_\_\_ service.
- The government is going to \_\_\_\_\_ the amount of tax on fuel next year.
- This box \_\_\_\_\_ nothing but old letters and photos.
- We didn't \_\_\_\_\_ to do much sightseeing because it was so hot and humid all the time.
- We had terrible rain and wind the whole time, and it \_\_\_\_\_ our holiday.
- When we got to the airport, she suddenly \_\_\_\_\_ she'd left her passport at home.



Even when verbs have very similar meanings, they can't always be used in the same way. For example, we can say *The road bends to the right*. OR *The road curves to the right*. But we can't say *Curve down and touch your toes*. We have to say *Bend down and touch your toes*.

# 51 Adverbs 1

Complete each sentence with the correct word from the box. Use each word once only.

angrily   carefully   continuously   ~~easily~~   extremely   finally  
heavily   lately   luckily   patiently   seriously   well

- 1 They say it's difficult to get a job in TV, but I found one easily.
- 2 You'd better take an umbrella with you. It's raining \_\_\_\_\_ at the moment.
- 3 It's been a really hard day today, so I should sleep \_\_\_\_\_ tonight.
- 4 They lived very close to the motorway, and cars and lorries \_\_\_\_\_ passed their house during the night. It was really hard to sleep sometimes.
- 5 'Mind your own business!' he shouted \_\_\_\_\_.
- 6 \_\_\_\_\_ she had her mobile with her, so when she got lost in the forest, she was able to phone for help.
- 7 The weather has been \_\_\_\_\_ cold recently. In fact, this is the coldest November for over seventy-five years.
- 8 Have you got any idea what's happened to Annie? I haven't seen her \_\_\_\_\_.
- 9 He took his driving test for the seventh time and \_\_\_\_\_ managed to pass it.
- 10 The roads are very icy tonight, so drive \_\_\_\_\_.
- 11 He crashed his motorbike, but he wasn't going fast so he wasn't \_\_\_\_\_ hurt. He just cut his hand.
- 12 The crowd waited \_\_\_\_\_ for the movie stars to arrive.



Test 58 on page 105 also practises adverbs.

# 52 Anagrams

An anagram has the same letters as another word, but in a different order. Sort out these anagrams.

- 1 Change **tied** into something you do to lose weight. diet
- 2 Change **small** into big shopping centres. \_\_\_\_\_
- 3 Change **each** into a word that means *pain*. \_\_\_\_\_
- 4 Change **fade** into a word that means you can't hear. \_\_\_\_\_
- 5 Change **rested** into a very hot, dry place. \_\_\_\_\_
- 6 Change **sport** into places where ships stop. \_\_\_\_\_
- 7 Change **grown** into the opposite of *right*. \_\_\_\_\_
- 8 Change **skis** into something you do with your lips. \_\_\_\_\_
- 9 Change **teach** into something dishonest people do. \_\_\_\_\_
- 10 Change **miles** into a sign of happiness. \_\_\_\_\_
- 11 Change **inch** into a part of the face. \_\_\_\_\_
- 12 Change **drawer** into a kind of prize. \_\_\_\_\_
- 13 Change **cars** into a mark from a deep cut that doesn't go away. \_\_\_\_\_
- 14 Change **dusty** into something students do. \_\_\_\_\_
- 15 Change **safer** into bad feelings. \_\_\_\_\_
- 16 Change **boredom** into a place where you sleep. \_\_\_\_\_



What are these words anagrams of?

face: c a f e

near: e \_ r \_

name: m \_ \_ n

notes: s \_ o \_ e

hated: d \_ a \_ h

thing: n \_ \_ \_ t

When you have worked them out, make up clues like this: *Change 'face' into a place for a coffee.* (Answer: *café*)

# 53 More word building

Use the words on the right to make a new word which fits the sentences.

- 1 At the show, the magician kept pulling rabbits out of his hat. **MAGIC**
- 2 Their dog barks a lot but he won't hurt you. He's completely \_\_\_\_\_. **HARM**
- 3 There's no \_\_\_\_\_ between my old bike and my new one. The new one is ten times better. **COMPARE**
- 4 I'm fed up with your \_\_\_\_\_. You're acting like a child. **BEHAVE**
- 5 People are usually quite shy about discussing their \_\_\_\_\_ in public. **BELIEVE**
- 6 This juice is full of artificial flavours. It tastes totally \_\_\_\_\_. **NATURAL**
- 7 It's been a great \_\_\_\_\_ getting to know you. I hope we meet again soon. **PLEASANT**
- 8 Put twenty pence in the machine and you can test your \_\_\_\_\_. **STRONG**
- 9 She's very \_\_\_\_\_. She's going to travel all around the world on her own for a whole year. **DEPEND**
- 10 There wasn't much of a \_\_\_\_\_ on the menu so I had a pizza again. **CHOOSE**
- 11 \_\_\_\_\_ it rained all weekend so we couldn't go on the cycling trip we'd planned. **FORTUNE**

- 12 I have very little \_\_\_\_\_ of the hotels and restaurants in this area. **KNOW**
- 13 We were all very impressed by the \_\_\_\_\_ of the countryside. **BEAUTIFUL**
- 14 In \_\_\_\_\_ to being good-looking and clever, he is also very rich. **ADD**
- 15 He's a very \_\_\_\_\_ person. He loses everything and is always late for meetings. **ORGANIZATION**
- 16 She grew up in the country and I think she had a very happy \_\_\_\_\_. **CHILD**
- 17 He's usually very kind and patient but just \_\_\_\_\_ he loses his temper. **OCCASION**



The suffix *-less* often has the meaning *without*. For example a *homeless* person is someone without a home.

The suffix *-ful* often gives the opposite meaning: *thoughtless* and *thoughtful* are opposites. Be careful, though. The opposite of *homeless* is not *homeful*!

# 54 Green issues

Complete the sentences with the correct words from the box.

artificial concrete crops ~~endangered~~ energy  
 environment factory free range fuel organic pesticides  
 polluted public transport traffic veal wildlife

- 1 Rhinos are an endangered species. We have to protect them or they will become extinct.

---

- 2 It's amazing how much \_\_\_\_\_ you can find in a city garden: foxes, hedgehogs, frogs and lots of birds and insects.

---

- 3 There's too much \_\_\_\_\_ in modern cities. Why can't we have more parks and open spaces instead of all these skyscrapers?

---

- 4 We need stricter laws to protect the \_\_\_\_\_ from the smoke and gases released by cars and factories.

---

- 5 I don't usually eat sweets. The \_\_\_\_\_ colourings and flavourings give me a headache.

---

- 6 This apple juice is \_\_\_\_\_. That means the fruit trees weren't sprayed with chemicals.

---

- 7 I only eat \_\_\_\_\_ chicken and eggs. I don't approve of chicken farms where the animals are kept in small cages.

---

- 8 Most farmers spray their \_\_\_\_\_ with \_\_\_\_\_ to stop insects eating them.

---

- 9 This farm is like a \_\_\_\_\_. The animals are treated like machines.

- 10 In order to produce \_\_\_\_\_, farmers take calves from their mothers when they are two weeks old and keep them in small, dark cages.

---

- 11 Oil is the main source of \_\_\_\_\_ in this country. It would be good to use cleaner sources like the wind and the sun.

---

- 12 There would be less \_\_\_\_\_ on the roads if the government made \_\_\_\_\_ cheaper.

---

- 13 Our new car is very economical on \_\_\_\_\_. It can do 100 kilometres on six litres.

---

- 14 A ship carrying oil crashed on the rocks here last year and now a lot of the coast is \_\_\_\_\_.



Try reinforcing your vocabulary in one area by making a word-web. For example, with words from this test you can make an environment word-web or a farm word-web. You could start your farm word-web like this:

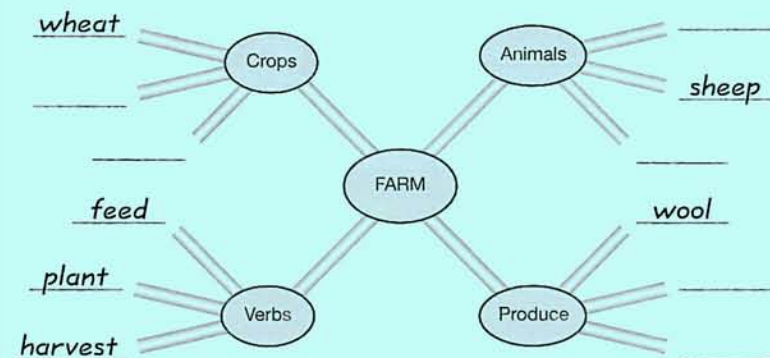

# 55 Adjectives and nouns

Choose the most suitable adjective for each noun.

damp deep haunted painful poisonous stale steep sticky  
stone ~~urgent~~ V-necked well-known



1 an urgent message



2 a steep hill

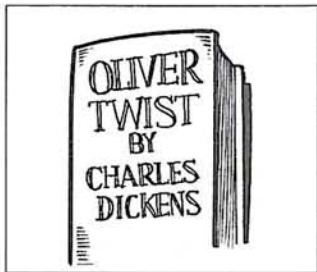

3 a well-known writer

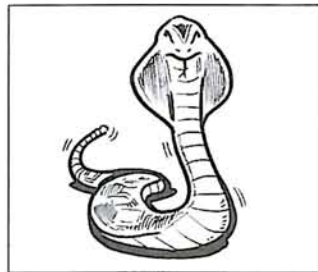

4 a poisonous snake

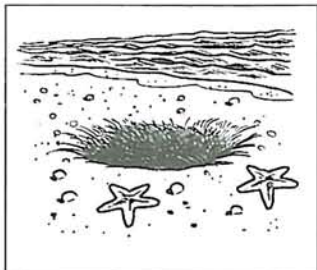

5 a shallow hole



6 a haunted house



7 a painful cut

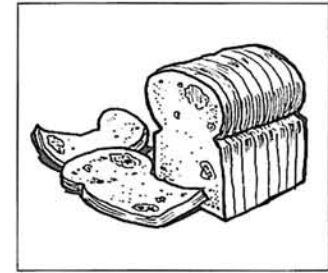

8 stale bread

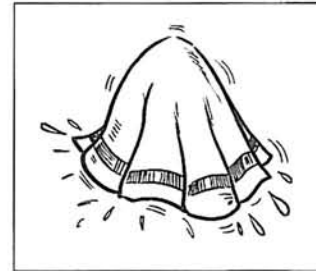

9 a damp cloth

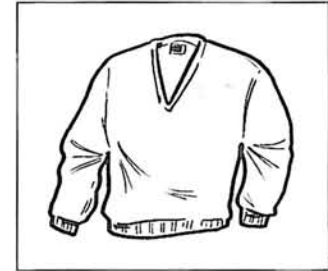

10 a V-necked sweater



11 sticky fingers

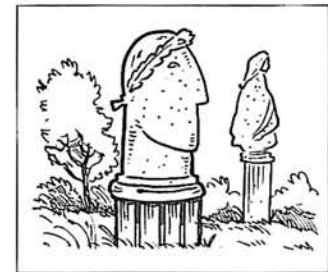

12 a stone statue



Some adjectives go with particular nouns. The adjective *stale*, for example, usually goes with the noun *bread*. It can also go with *cake*, *biscuits*, *buns* and other baked food. We can't say that meat or milk is stale. Meat can be *off* or *rotten*. Milk can be *off* or *sour*.

*I had to throw the sausages away. They were off. / They were rotten.  
Don't use that milk. I think it's off.*

# 56 Same word, different meaning

In each pair of sentences below, the missing word is the same but the meaning is different. What are the missing words?

- 1 change Let's go out tonight for a \_\_\_\_\_. I'm fed up with cooking. Have you got any \_\_\_\_\_? I've only got a £10 note.
- 2 \_\_\_\_\_ My brother can't stand the sight of blood. It always makes him \_\_\_\_\_. Her voice on the phone was so \_\_\_\_\_ that I could hardly hear it.
- 3 \_\_\_\_\_ She doesn't have a \_\_\_\_\_ account. She keeps her money under the mattress. We saw him sitting on the river \_\_\_\_\_ fishing.
- 4 \_\_\_\_\_ I can't \_\_\_\_\_ that man. He really gets on my nerves. We saw a \_\_\_\_\_ in the forest when we were camping in California.
- 5 \_\_\_\_\_ You have to \_\_\_\_\_ three egg whites to make this pudding. Argentina \_\_\_\_\_ Germany 2-0 in the final.
- 6 \_\_\_\_\_ I don't have to wear a \_\_\_\_\_ to work. I just go in jeans and a T-shirt. She bent down to \_\_\_\_\_ up her shoelace.
- 7 \_\_\_\_\_ She had a cold and the \_\_\_\_\_ of her nose was red. The waiter was really helpful so we gave him a big \_\_\_\_\_.
- 8 \_\_\_\_\_ She wants curtains that will \_\_\_\_\_ her carpet. It was the most exciting football \_\_\_\_\_ I've ever seen.

- 9 \_\_\_\_\_ Use a first-class \_\_\_\_\_ if you want the letter to arrive by tomorrow. Everyone began to \_\_\_\_\_ their feet in time to the music.
- 10 \_\_\_\_\_ I'm tired. I think I'll go and \_\_\_\_\_ down for a while. I didn't say that! That's a \_\_\_\_\_!
- 11 \_\_\_\_\_ I need to go to the gym every day to try to get into \_\_\_\_\_ again. A rugby ball is a different \_\_\_\_\_ from a football.
- 12 \_\_\_\_\_ She dropped my favourite china vase and it \_\_\_\_\_. I've just spent all my money on a new sound system. I am now completely \_\_\_\_\_.
- 13 \_\_\_\_\_ I parked my car on a double yellow line and I got a £30 \_\_\_\_\_. I heard the weather forecast and apparently it's going to be \_\_\_\_\_ today.
- 14 \_\_\_\_\_ One, three, five and seven are odd numbers. Two, four, six and eight are \_\_\_\_\_. I'm not going out \_\_\_\_\_ if it stops raining. I'm too cold and tired.
- 15 \_\_\_\_\_ I have absolutely no \_\_\_\_\_ in politics. I like art, music and literature. You can get about 6% \_\_\_\_\_ in this savings account.
- 16 \_\_\_\_\_ She's a good teacher because she's very \_\_\_\_\_. Doctor Fernandez has received another card from a grateful \_\_\_\_\_.



Here are some silly jokes based on words that have two meanings.

**A:** Have you noticed any change in me?

**B:** No. Why?

**A:** Well I've just swallowed twenty-five pence by accident.

**Question:** How do you keep cool at a football match?

**Answer:** Stand next to a fan.

# 57 Rhyming words

Complete the sentences. The missing words rhyme with the words in brackets.

- 1 There's no-one on the tennis court. Let's go and play. (*port*)
- 2 My \_\_\_\_\_ is so sore I can hardly swallow. (*goat*)
- 3 Don't \_\_\_\_\_ your brother about his spots. He doesn't like it. (*please*)
- 4 We can't eat this bread, it's \_\_\_\_\_. (*rail*)
- 5 The air was so dusty it made me \_\_\_\_\_. (*trees*)
- 6 The rules at this school are very \_\_\_\_\_. You have to obey them. (*picked*)
- 7 The \_\_\_\_\_ of my shirt is filthy. I must go and change. (*dollar*)
- 8 It's getting very late. I \_\_\_\_\_ if they'll come now. (*shout*)
- 9 I don't wear much make-up – just lipstick and \_\_\_\_\_. (*louder*)
- 10 I'm going to water the garden. Can you turn the \_\_\_\_\_ on, please? (*toes*)
- 11 He's got a job as a \_\_\_\_\_ in a new French restaurant. (*deaf*)
- 12 Don't touch the cat. He's in a bad mood and might \_\_\_\_\_ you. (*match*)
- 13 She's a very \_\_\_\_\_ girl. She's got strange ideas about everything. (*beard*)
- 14 Alice fell off her bike last week and broke her \_\_\_\_\_. (*missed*)
- 15 Let's go into the garden and sunbathe on the \_\_\_\_\_. (*born*)
- 16 We need some \_\_\_\_\_ to tie around this broken suitcase. (*soap*)
- 17 You'd better not speak to me today. I'm in a really bad \_\_\_\_\_. (*rude*)
- 18 My brother has a \_\_\_\_\_ and he spends the whole summer sailing. (*shot*)
- 19 This house is haunted! There's a \_\_\_\_\_ in the attic. (*roast*)
- 20 Can you \_\_\_\_\_ some cheese to put on top of the pasta? (*weight*)

# 58 Adverbs 2

Complete the sentences with the correct words from the box. Use each word once only.

absolutely annually anxiously comfortably completely deliberately  
fortunately ~~happily~~ hardly normally unexpectedly violently

- 1 Mike and Cathy Chambers have been happily married for eighteen years.
- 2 It wasn't an accident! She did it \_\_\_\_\_. I saw her.
- 3 I \_\_\_\_\_ have toast and tea for breakfast but today for a change I had a boiled egg.
- 4 Have you seen Poppy and Dave's new house? It's \_\_\_\_\_ enormous!
- 5 My grandfather was sitting so \_\_\_\_\_ in the new armchair that he fell asleep.
- 6 When he returned to his village after fifteen years, he found that everything had \_\_\_\_\_ changed. The place wasn't a village any more – it was now a town.
- 7 His friends had changed so much that he \_\_\_\_\_ recognized them any more.
- 8 My parents arrived at my flat \_\_\_\_\_. I had no idea they were coming today.
- 9 There was an accident on the motorway this morning, but \_\_\_\_\_ no-one was hurt.
- 10 She waited \_\_\_\_\_ by the phone for news of her missing daughter.
- 11 I could tell he was angry because he banged his glass down on the table \_\_\_\_\_.
- 12 That book is published \_\_\_\_\_ but we haven't got this year's edition of it. We've only got last year's.



We form adverbs of manner by adding *-ly* or *-ily* to the adjective: *careful / carefully, angry / angrily*. When an adjective ends in *-le*, we form the adverb by deleting the *-e* and adding *-y*: *simple / simply*.



# 59 Choose the adjective

Complete the sentences on the left with the correct ending from the right.

- 1 A blonde girl or boy has fair hair. very curious
- 2 An awkward person is \_\_\_\_\_. offices in many countries
- 3 A contented person is \_\_\_\_\_. clumsy
- 4 An ancient monument is \_\_\_\_\_. about to fall down
- 5 An extraordinary experience is \_\_\_\_\_. real
- 6 A nosy person is \_\_\_\_\_. good at making things
- 7 A delicious meal is \_\_\_\_\_. ~~fair hair~~
- 8 A complicated story is \_\_\_\_\_. debt
- 9 An imaginary illness isn't \_\_\_\_\_. unmarried
- 10 A historical novel is \_\_\_\_\_. fashionable and smart
- 11 An evil dictator is \_\_\_\_\_. very tasty
- 12 A multinational company has \_\_\_\_\_. about the past
- 13 A painful decision is \_\_\_\_\_. meat
- 14 A secure shelf isn't \_\_\_\_\_. a lot of money
- 15 A single person is \_\_\_\_\_. amazing and unusual
- 16 A creative person is \_\_\_\_\_. very old
- 17 A stylish girl is \_\_\_\_\_. wicked and cruel
- 18 A successful business makes \_\_\_\_\_. hard to make
- 19 A vegetarian meal doesn't contain \_\_\_\_\_. satisfied
- 20 An unpaid bill is a \_\_\_\_\_. hard to follow



Some adjectives can only go with certain nouns. We can only use the word *blonde*, for example, to talk about people. We can't use it to describe the colour of an animal or a thing.

# 60 What's the verb?

Complete the sentences with the correct words from the box. Use each word once only.

break catch change cross deliver ~~grow~~ lose  
make open roll run share tell tie twist win

- 1 Roses, plants, your hair are things you grow.
- 2 Letters, babies, parcels are things you \_\_\_\_\_.
- 3 Trains, buses, a cold are things you \_\_\_\_\_.
- 4 Doors, windows, a bank account are things you \_\_\_\_\_.
- 5 Shoelaces, knots, ribbons are things you \_\_\_\_\_.
- 6 Money, your mind, jobs are things you \_\_\_\_\_.
- 7 A border, a road, your fingers are things you \_\_\_\_\_.
- 8 A promise, a bone, a record are things you \_\_\_\_\_.
- 9 Lies, stories, jokes are things you \_\_\_\_\_.
- 10 A company, a race, a bath are things you \_\_\_\_\_.
- 11 Your job, your memory, weight are things you \_\_\_\_\_.
- 12 Competitions, prizes, battles are things you \_\_\_\_\_.
- 13 A bed, a decision, a mess are things you \_\_\_\_\_.
- 14 Your ankle, your knee, somebody's words are things you \_\_\_\_\_.
- 15 Dice, your eyes, cigarettes are things you \_\_\_\_\_.
- 16 An opinion, a room, a taxi are things you \_\_\_\_\_.



- A bilingual dictionary can be very useful for a quick translation of simple words. However, you must be careful to find the right translation if a word has several meanings. For example, in English we can use the verb *catch* in both these sentences: *I'm in a hurry, I have to catch a train.* and *Keep warm or you'll catch a cold.* Can you use the same word in your language?
- If somebody decides they want to have long hair, they say they are growing it.  
'Your hair's longer than usual.'  
'Yes, I'm growing it. I haven't had it cut for six months now.'

# Answers

## Test 1

blender 4  
bottle opener 9  
briefcase 6  
broom 3  
coat hanger 12  
dustpan 2  
light bulb 1  
pepper grinder 10  
potato peeler 7  
suitcase 5  
tea towel 8  
tray 11

## Test 2

### Across

1 superficial  
6 relaxed  
8 popular  
10 reliable  
13 brave  
14 honest  
15 patient  
17 grateful

### Down

1 sensible  
2 independent  
3 lively  
4 miserable  
5 mature  
7 jealous  
9 weird  
11 generous  
12 proud  
16 warm

## Test 3

1 got over  
2 told him off  
3 ran out of  
4 brought them up  
5 put it off  
6 picking me up  
7 shows off  
8 broke down  
9 took off  
10 put out

11 kept on  
12 blew it up  
13 knocked him out  
14 turned up  
15 set out  
16 cut down  
17 let her down  
18 hung up

## Test 4

ankle 12  
bottom 1  
cheek 5  
chest 10  
chin 4  
elbow 9  
lips 6  
stomach 11  
throat 3  
thumb 7  
waist 2  
wrist 8

## Test 5

1 k potatoes  
2 g eggs  
3 b bread  
4 h fish  
5 a boiled eggs  
6 f curry  
7 d chocolate  
8 m steak  
9 c cola  
10 i milk  
11 e cream  
12 j mineral water  
13 l tea  
14 o wine  
15 n tomatoes

## Test 6

branch 4  
burglar alarm 12  
bush 15  
chimney 8  
door handle 9  
dustbin 3  
flowerpot 2

French windows 6  
greenhouse 5  
hedge 16  
hose 1  
lawn 10  
letterbox 7  
patio 13  
satellite dish 11  
tap 14

## Test 7

1 rational  
2 tiny  
3 artificial  
4 exciting  
5 cautious  
6 broad-minded  
7 sudden  
8 uninterested  
9 unlucky  
10 sensitive  
11 light-hearted  
12 pessimistic  
13 delicious  
14 gentle

a emotional  
b disgusting  
c broad-minded  
d aggressive  
e artificial  
f gradual  
g optimistic  
h daring  
i pessimistic  
j sensitive

## Test 8

1 burglar  
2 dealers  
3 theft  
4 hooligans  
5 drink driving  
6 speeding  
7 bullies  
8 fine  
9 judge  
10 shoplifting

11 violence  
12 graffiti  
13 gangs  
14 robbers  
15 mugged

## Test 9

1 model  
2 speech therapist  
3 farmer  
4 cashier  
5 caretaker  
6 driving instructor  
7 pilot  
8 astronaut  
9 estate agent  
10 chef  
11 diver  
12 lawyer  
13 engineer  
14 surgeon  
15 lifeguard

## Test 10

beat 6  
chop 3  
grate 5  
heat 11  
mix 4  
peel 8  
roast 1  
slice 7  
spread 10  
squeeze 2  
stir 12  
whip 9

## Test 11

1 b) put up  
2 a) an only  
3 c) left  
4 c) get on  
5 d) bring up  
6 b) regret  
7 b) support  
8 c) bargain  
9 a) save  
10 d) unemployed  
11 a) beat  
12 b) platform

## Test 12

aubergine 4  
broccoli 1  
cabbage 12  
cauliflower 8  
cherry 5  
coconut 9  
courgette 3  
cucumber 2  
fig 14  
onion 11  
peach 13  
pepper 6  
plum 10  
tangerine 7

## Test 13

1 application form  
2 advertisement  
3 CV  
4 career  
5 interview  
6 driving licence  
7 skills  
8 qualifications  
9 organized  
10 sense of humour  
11 offer  
12 references  
13 full-time  
14 well-paid  
15 starting salary  
16 temporary  
17 stressful  
18 unemployed  
19 part-time  
20 training course

## Test 14

1 whispered  
2 warned  
3 inform  
4 explained  
5 reminded  
6 insulted  
7 deny  
8 advised  
9 persuaded  
10 contacted  
11 advertising  
12 demanded

13 translate  
14 interrupting  
15 congratulating  
16 presents

## Test 15

1 Breathe (j)  
2 scratch (f)  
3 blow (b)  
4 snoring (k)  
5 screamed (n)  
6 weeping (h)  
7 sneeze (a)  
8 examine (m)  
9 relax (c)  
10 bleeding (i)  
11 fainted (e)  
12 cured (d)  
13 hugged (p)  
14 comfort (o)  
15 dream (g)  
16 rest (l)

## Test 16

1 fancied  
2 shared  
3 annoy  
4 embarrassed  
5 forced  
6 argue  
7 offended  
8 support  
9 behaved  
10 criticize  
11 apologized  
12 pretended  
13 communicate  
14 separated  
15 regret

## Test 17

A  
1 unattractive  
2 incorrect  
3 independent  
4 inexpensive  
5 unfashionable  
6 informal  
7 unhealthy  
8 uninteresting  
9 immature  
10 immoral

- 11 impatient
- 12 unpleasant
- 13 impolite
- 14 unpopular
- 15 impossible
- 16 impractical
- 17 insensitive
- 18 unusual

**B**

- 1 immature
- 2 independent
- 3 unpopular
- 4 incorrect
- 5 unusual
- 6 insensitive
- 7 informal
- 8 impractical
- 9 unhealthy
- 10 immoral
- 11 inexpensive
- 12 impatient

**Test 18**

- banister 11
- basket 4
- board 15
- bucket 2
- candle 9
- CD rack 17
- doormat 1
- extractor fan 10
- hat stand 16
- hook 3
- landing 7
- mop 14
- padlock 5
- plate rack 6
- rope 12
- string 18
- strip light 8
- thermometer 13

**Test 19****Across**

- 1 immature
- 5 talented
- 7 sympathetic
- 8 timid
- 9 obstinate
- 11 moody
- 12 violent

**Down**

- 2 eccentric
- 3 adventurous
- 4 self-confident
- 6 ambitious
- 7 strict
- 10 nosy

**Test 20**

- 1 file/folder
- 2 virus
- 3 download
- 4 crash
- 5 website
- 6 icon
- 7 e-card
- 8 laptop
- 9 keyboard
- 10 key
- 11 CD ROM
- 12 backup

**Test 21**

- aftershave 4
- antiseptic 14
- aspirin 7
- bandage 3
- blusher 12
- cotton wool 8
- deodorant 1
- hand cream 2
- lipstick 10
- mascara 13
- plaster 5
- shampoo 11
- sponge bag 9
- talcum powder 6

**Test 22****Across**

- 1 depart
- 6 organize
- 8 spreading
- 12 pack
- 13 celebrate
- 14 rush
- 15 rowed
- 16 sink
- 17 lead

**Down**

- 1 diving
- 2 recovered
- 3 train
- 4 dare
- 5 chased
- 7 attacked
- 8 searching
- 9 floats
- 10 marched
- 11 enter

**Test 23**

- bat 4
- bee 1
- crocodile 13
- frog 15
- gazelle 5
- hedgehog 9
- leopard 7
- lizard 12
- mosquito 2
- salmon 6
- scorpion 11
- seal 17
- swan 18
- tarantula 16
- tortoise 14
- tuna 8
- turkey 3
- whale 10

**Large birds**

- swan, turkey

**African mammals**

- gazelle, leopard

**Fish**

- salmon, tuna

**Small mammals**

- bat, hedgehog

**Sea mammals**

- seal, whale

**Land reptiles**

- lizard, tortoise

**Insects**

- bee, mosquito

**Poisonous animals**

- scorpion, tarantula

**Animals that live in rivers (not fish)**

- crocodile, frog

**Test 24****A**

- 1 clothes
- 2 nail
- 3 coat
- 4 dressing
- 5 telephone
- 6 tooth
- 7 hair
- 8 head
- 9 sun
- 10 shoe

**B**

- 1 clothes line
- 2 telephone number
- 3 coat hanger
- 4 shoe polish
- 5 clothes peg
- 6 dressing table
- 7 hair clip
- 8 headphones
- 9 telephone directory
- 10 nail file
- 11 hair spray
- 12 coat rack
- 13 dressing gown
- 14 headache
- 15 toothbrush
- 16 nail varnish
- 17 sun cream
- 18 shoelace
- 19 sunglasses
- 20 toothpaste

**Test 25**

- apron 4
- blouse 10
- bow tie 15
- button 2
- cardigan 9
- collar 11
- cuff 1
- dungarees 8
- heels 20
- hem 16
- hood 19
- laces 14

- pocket 3
- sleeve 17
- strap 7
- underwear 5
- uniform 12
- vest 18
- waistcoat 6
- zip 13

**Test 26**

- 1 b) improves
- 2 b) stopped
- 3 d) an employee
- 4 d) chance
- 5 a) countryside
- 6 b) bossy
- 7 d) spoilt
- 8 d) gets out of
- 9 b) ambitious
- 10 c) punctual
- 11 b) grateful
- 12 a) stayed up

**Test 27**

- 1 h) Sorry to keep you waiting.
- 2 e) I'll do my best.
- 3 f) I'm afraid not. Can I take a message?
- 4 g) It wasn't my fault.
- 5 a) Can I give you a hand?
- 6 b) Can you keep an eye on them for a minute?
- 7 c) Don't bother.
- 8 d) I wouldn't do that if I were you.

**Test 28****A**

- 1 card
- 2 pin
- 3 ring
- 4 board
- 5 basket
- 6 knife
- 7 case
- 8 rack
- 9 bag
- 10 paper

**B**

- 1 business card
- 2 earring
- 3 drawing pin
- 4 birthday card
- 5 bread knife
- 6 briefcase
- 7 floorboard
- 8 handbag
- 9 key ring
- 10 laundry basket
- 11 newspaper
- 12 notice board
- 13 penknife
- 14 picnic basket
- 15 pillow case
- 16 plate rack
- 17 roof rack
- 18 safety pin
- 19 sleeping bag
- 20 wallpaper

**Test 29**

- binoculars 4
- chess set 11
- dartboard 3
- dice 8
- fishing rod 12
- flippers 9
- fruit machine 2
- golf club 10
- jukebox 14
- knee pads 1
- net 16
- playing cards 13
- ski stick 15
- snorkel 5
- table tennis bat 7
- weights 6

**Test 30****A**

- 1 achievement
- 2 agreement
- 3 appearance
- 4 communication
- 5 confidence
- 6 difference
- 7 distance
- 8 education
- 9 experience

- 10 experiment  
11 friendship  
12 importance  
13 information  
14 invention  
15 leadership  
16 opportunity  
17 performance  
18 possibility  
19 quality  
20 quantity  
21 relationship  
22 situation  
23 unemployment  
24 violence
- B**
- 1 achievement  
2 violence  
3 confidence  
4 relationship  
5 possibility  
6 experiment  
7 appearance  
8 experience  
9 agreement  
10 opportunity  
11 unemployment  
12 quality  
13 leadership  
14 invention  
15 distance
- Test 31**
- 1 edits magazines  
2 adds up figures  
3 entertains an audience  
4 performs plays  
5 records songs  
6 cleans old paintings  
7 puts up wallpaper  
8 makes cakes  
9 marks essays  
10 treats patients  
11 checks passports and visas  
12 takes away the rubbish  
13 measures land  
14 serves meals

- 15 delivers letters and parcels
- Test 32**
- 1 complete  
2 capitals  
3 ink  
4 surname  
5 forenames  
6 birth  
7 sex  
8 title  
9 status  
10 nationality  
11 occupation  
12 purpose  
13 permanent  
14 temporary  
15 code  
16 telephone  
17 length  
18 signature
- Test 33**
- A**
- Colour**  
beige, cream, navy
- Shape**  
rectangular, oval, triangular
- Size**  
gigantic, massive, minute
- Describing food**  
bitter, juicy, ripe
- Describing weather**  
boiling, cool, humid
- Texture**  
furry, rough, smooth
- B**
- 1 ripe  
2 smooth  
3 humid  
4 juicy  
5 navy  
6 minute  
7 furry  
8 triangular  
9 boiling  
10 oval

- Test 34**
- 1 famine  
2 drought  
3 drowned  
4 earthquake  
5 lightning  
6 hijack  
7 disease  
8 volcano  
9 flood  
10 crashed  
11 kidnapped  
12 hurricane
- Test 35**
- aerial 12  
bonnet 1  
boot 3  
bumper 6  
engine 9  
gear stick 18  
hand brake 17  
indicator 4  
mirror 13  
number plate 5  
petrol cap 15  
seatbelt 16  
speedometer 14  
steering wheel 2  
tyre 8  
wheel 7  
windscreen 11  
windscreen wipers 10
- Test 36**
- 1 b) in  
2 a) in  
3 c) about  
4 c) among  
5 b) from  
6 c) to  
7 a) by  
8 b) between  
9 a) above  
10 c) against  
11 a) behind  
12 c) at

- Test 37**
- bald 15  
beard 17  
bun 12  
chubby cheeks 4  
double chin 5  
earring 14  
freckles 2  
fringe 1  
middle-parting 9  
moustache 16  
plait 3  
pony tail 10  
scar 6  
side-parting 11  
stubble 7  
tattoo 8  
wrinkles 13
- Test 38**
- 1 allowed  
2 trusted  
3 terrify  
4 wish  
5 pretended  
6 recognized  
7 disapprove  
8 supposed  
9 solve  
10 compare  
11 confuse  
12 admires  
13 prove  
14 intended  
15 tease  
16 deserve
- Test 39**
- 1 chips  
2 trash  
3 restroom  
4 clerk  
5 cab  
6 drugstore  
7 round trip  
8 subway  
9 elevator  
10 faucet  
11 parking lot  
12 deck  
13 stand in line

- 14 sidewalk  
15 apartment  
16 downtown
- Test 40**
- 1 h  
2 g  
3 b  
4 d  
5 a  
6 f  
7 e  
8 c
- Test 41**
- 1 invented  
2 lying  
3 canals  
4 check  
5 countryside  
6 receipt  
7 remind  
8 fetching  
9 else  
10 an appointment  
11 match  
12 broke  
13 industrious  
14 bring  
15 superstitious
- Test 42**
- A**
- 1 refuse  
2 loathe  
3 defend  
4 destroy  
5 discourage  
6 improve  
7 decrease  
8 disobey  
9 criticize  
10 appear
- B**
- 1 defend  
2 improved  
3 loathe  
4 encouraged  
5 vanished  
6 praised  
7 accept

- 8 obeys  
9 destroyed  
10 attacked  
11 increased  
12 discourage
- Test 43**
- 1 c) on  
2 b) for  
3 a) in  
4 b) under  
5 c) from  
6 b) with  
7 c) of  
8 a) from  
9 b) for  
10 c) to  
11 a) for  
12 a) of
- Test 44**
- ambulance 4  
bus 9  
canoe 6  
caravan 15  
coach 13  
estate car 5  
ferry 12  
helicopter 16  
lorry 7  
motorbike 18  
plane 3  
rocket 10  
scooter 1  
sports car 8  
submarine 11  
tractor 17  
van 2  
yacht 14
- Test 45**
- 1 mad  
2 reliable  
3 immature  
4 intentional  
5 revolting  
6 coarse  
7 starving  
8 absurd  
9 pathetic  
10 weird  
11 attractive

- 12 anxious  
13 cheerful  
14 relaxed  
15 confident

**Test 46**

- 1 put her up  
2 broken up  
3 take up  
4 dropped out  
5 get out of  
6 got by  
7 turned it down  
8 held up  
9 went on  
10 went off  
11 worked out  
12 call off

**Test 47**

- 1 newspaper  
2 catalogue  
3 atlas  
4 romantic novel  
5 encyclopedia  
6 album  
7 calendar  
8 diary  
9 index  
10 map  
11 manual  
12 timetable  
13 brochure  
14 recipe book  
15 directory  
16 dictionary  
17 comic  
18 register

**Test 48**

- 1 plastic/materials  
2 well/adverbs  
3 earrings/jewellery  
4 from/prepositions  
5 burglary/crimes  
6 jazz/music  
7 darts/games  
8 silk/cloth  
9 wet/adjectives  
10 sardine/fish  
11 ostrich/birds  
12 bear/mammals

- 13 knickers/underwear  
14 carton/containers  
15 deodorant/toiletries  
16 mascara/make-up  
17 boots/footwear  
18 brochure/publications  
19 van/vehicles  
20 flood/disasters

**Test 49**

- 1 weight, wait  
2 brakes, breaks  
3 piece, peace  
4 knot, not  
5 guessed, guest  
6 chews, choose  
7 allowed, aloud  
8 sure, shore  
9 stares, stairs  
10 higher, hire  
11 rows, rose  
12 fined, find  
13 sew, so  
14 bear, bare  
15 caught, court

**Test 50**

- A**  
1 organize  
2 curve  
3 reduce  
4 swap  
5 contain  
6 cheat  
7 realize  
8 rescue  
9 ruin  
10 manage

**B**

- 1 bends/curves  
2 Bend  
3 noticed  
4 arrange/organize  
5 lies  
6 exchange/swap  
7 cheats  
8 succeeded  
9 saved/rescued  
10 include  
11 lower/reduce  
12 contains

- 13 manage  
14 spoilt/ruined  
15 noticed/realized

**Test 51**

- 1 easily  
2 heavily  
3 well  
4 continuously  
5 angrily  
6 Luckily  
7 extremely  
8 lately  
9 finally  
10 carefully  
11 seriously  
12 patiently

**Test 52**

- 1 diet  
2 malls  
3 ache  
4 deaf  
5 desert  
6 ports  
7 wrong  
8 kiss  
9 cheat  
10 smile  
11 chin  
12 reward  
13 scar  
14 study  
15 fears  
16 bedroom

**Tip**

café  
earn  
mean  
stone  
death  
night

**Test 53**

- 1 magician  
2 harmless  
3 comparison  
4 behaviour  
5 beliefs  
6 unnatural  
7 pleasure

- 8 strength  
9 independent  
10 choice  
11 Unfortunately  
12 knowledge  
13 beauty  
14 addition  
15 disorganized  
16 childhood  
17 occasionally

**Test 54**

- 1 endangered  
2 wildlife  
3 concrete  
4 environment  
5 artificial  
6 organic  
7 free range  
8 crops, pesticides  
9 factory  
10 veal  
11 energy  
12 traffic, public transport  
13 fuel  
14 polluted

**Test 55**

- 1 urgent  
2 steep  
3 well-known  
4 poisonous  
5 deep  
6 haunted  
7 painful  
8 stale  
9 damp  
10 V-necked  
11 sticky  
12 stone

**Test 56**

- 1 change  
2 faint  
3 bank  
4 bear  
5 beat

- 6 tie  
7 tip  
8 match  
9 stamp  
10 lie  
11 shape  
12 broke  
13 fine  
14 even  
15 interest  
16 patient

**Test 57**

- 1 court  
2 throat  
3 tease  
4 stale  
5 sneeze  
6 strict  
7 collar  
8 doubt  
9 powder  
10 hose  
11 chef  
12 scratch  
13 weird  
14 wrist  
15 lawn  
16 rope  
17 mood  
18 yacht  
19 ghost  
20 grate

**Test 58**

- 1 happily  
2 deliberately  
3 normally  
4 absolutely  
5 comfortably  
6 completely  
7 hardly  
8 unexpectedly  
9 fortunately  
10 anxiously  
11 violently  
12 annually

**Test 59**

- 1 fair hair  
2 clumsy  
3 satisfied  
4 very old  
5 amazing and unusual  
6 very curious  
7 very tasty  
8 hard to follow  
9 real  
10 about the past  
11 wicked and cruel  
12 offices in many countries  
13 hard to make  
14 about to fall down  
15 unmarried  
16 good at making things  
17 fashionable and smart  
18 a lot of money  
19 meat  
20 debt

**Test 60**

- 1 grow  
2 deliver  
3 catch  
4 open  
5 tie  
6 change  
7 cross  
8 break  
9 tell  
10 run  
11 lose  
12 win  
13 make  
14 twist  
15 roll  
16 share

# Word list

The numbers after the entries are the tests in which they appear.

## A

about 36  
 above 36  
 absolutely 58  
 absurd 45  
 accept 42  
 accountant 31  
 ache 52  
 achievement 30  
 actor 31  
 add up 31  
 addition 53  
 admire 38  
 adore 42  
 adventurous 19  
 advertise 14  
 advertisement 13  
 advise 14  
 aerial 35  
 aftershave 21  
 against 36  
 aggressive 7  
 agreement 30  
 album 47  
 allow 38  
 aloud 49  
 amazing 59  
 ambitious 19  
 ambulance 44  
 among 36  
 angrily 51  
 ankle 4  
 annoy 16  
 annually 58  
 antiseptic 21  
 anxious 45  
 anxiously 58  
 apartment 39  
 apologize 16  
 appear 42  
 appearance 30  
 application form 13  
 appointment 41  
 apron 25

argue 16  
 arrange 50  
 art restorer 31  
 artificial 7  
 aspirin 21  
 astronaut 9  
 at 36  
 atlas 47  
 attack 22  
 attractive 45  
 aubergine 12  
 audience 31

## B

backup 20  
 baker 31  
 bald 37  
 bandage 21  
 banister 18  
 bank 56  
 bare 49  
 bargain 11  
 basket 18  
 bat 23  
 bear 48  
 beard 37  
 beat 10  
 beauty 53  
 bedroom 52  
 bee 23  
 behave 16  
 behaviour 53  
 behind 36  
 beige 33  
 beliefs 53  
 bend 50  
 between 36  
 binoculars 29  
 birth 32  
 birthday card 28  
 bitter 33  
 bleed 15  
 blender 1  
 blouse 25  
 blow 15

blow up 3  
 blusher 21  
 board 18  
 boiled eggs 5  
 boiling 33  
 bonnet 35  
 boot 35  
 boots 48  
 bossy 26  
 bottle opener 1  
 bottom 4  
 bow tie 25  
 brakes 49  
 brake light 35  
 branch 6  
 brave 2  
 bread 5  
 bread knife 28  
 break 49  
 break down 3  
 break up 46  
 breathe 15  
 briefcase 1  
 bring 41  
 bring up 3  
 broad-minded 7  
 broccoli 12  
 brochure 47  
 broke 41  
 broom 1  
 bucket 18  
 bullies 8  
 bumper 35  
 bun 37  
 burglar 8  
 burglar alarm 6  
 burglary 48  
 bus 44  
 bush 6  
 business card 28  
 button 25  
 by 36

## C

cab 39

cabbage 12  
 cake 31  
 calendar 47  
 call off 46  
 canals 41  
 candle 18  
 canoe 44  
 capitals 32  
 caravan 44  
 cardigan 25  
 career 13  
 carefully 51  
 caretaker 9  
 carton 48  
 cashier 9  
 catalogue 47  
 catch 49  
 cauliflower 12  
 cautious 7  
 CD rack 18  
 CD ROM 20  
 celebrate 22  
 chance 26  
 change 56  
 chase 22  
 cheat 50  
 check 31  
 cheek 4  
 cheerful 45  
 chef 9  
 cherry 12  
 chess set 29  
 chest 4  
 chew 49  
 childhood 53  
 chimney 6  
 chin 4  
 chips 39  
 chocolate 5  
 choice 53  
 choose 49  
 chop 10  
 chubby cheeks 37  
 clean 31  
 clerk 39  
 clothes line 24  
 clothes peg 24  
 clumsy 59  
 coach 44  
 coarse 45

coat hanger 1  
 coat rack 24  
 coconut 12  
 code 32  
 cola 5  
 collar 25  
 college lecturer 31  
 comedian 31  
 comfort 15  
 comfortably 58  
 comic 47  
 communicate 16  
 communication 30  
 compare 38  
 comparison 53  
 complete 32  
 completely 58  
 concrete 54  
 confidence 30  
 confident 45  
 confuse 38  
 congratulate 14  
 contact 14  
 contain 50  
 continuously 51  
 cool 33  
 cotton wool 21  
 countries 59  
 countryside 26  
 courgette 12  
 courier 31  
 court 49  
 crash 20  
 cream 5  
 create 42  
 criticize 16  
 crocodile 23  
 crops 54  
 cross 60  
 cruel 59  
 cucumber 12  
 cuff 25  
 cure 15  
 curious 59  
 curry 5  
 curve 50  
 cut down 3  
 CV 13

## D

damp 55  
 dare 22  
 daring 7  
 dartboard 29  
 darts 48  
 deaf 52  
 dealers 8  
 debt 59  
 deck 39  
 decorator 31  
 decrease 42  
 deep 55  
 defend 42  
 deliberately 58  
 delicious 7  
 deliver 31  
 demand 14  
 deny 14  
 deodorant 21  
 depart 22  
 desert 52  
 deserve 38  
 destroy 42  
 diary 47  
 dice 29  
 dictionary 47  
 diet 52  
 difference 30  
 directory 47  
 disapprove 38  
 discourage 42  
 disease 34  
 disgusting 7  
 disobey 42  
 disorganized 53  
 distance 30  
 diver 9  
 diving 22  
 doctor 31  
 door handle 6  
 doormat 18  
 double chin 37  
 doubt 57  
 download 20  
 downtown 39  
 drawing pin 28  
 dream 15  
 dressing gown 24  
 dressing table 24

drink driving 8  
 driving instructor 9  
 driving licence 13  
 drop out 46  
 drought 34  
 drown 34  
 drugstore 39  
 dull 7  
 dungarees 25  
 dustbin 6  
 dustpan 1

## E

earring 28  
 earthquake 34  
 easily 51  
 e-card 20  
 eccentric 19  
 edit 31  
 editor 31  
 education 30  
 eggs 5  
 elbow 4  
 elevator 39  
 else 41  
 embarrass 16  
 emotional 7  
 employee 26  
 encourage 42  
 encyclopedia 47  
 endangered 54  
 energy 54  
 engine 35  
 engineer 9  
 enter 22  
 entertain 31  
 environment 54  
 essays 31  
 estate agent 9  
 estate car 44  
 even 56  
 examine 15  
 exchange 50  
 exciting 7  
 experience 30  
 experiment 30  
 explain 14  
 extractor fan 18  
 extremely 51

## F

factory 54  
 faint 15  
 fair 59  
 fall down 59  
 famine 34  
 fancy 16  
 farmer 9  
 fashionable 59  
 faucet 39  
 fears 52  
 ferry 44  
 fetch 41  
 fig 12  
 figures 31  
 file 20  
 finally 51  
 find 49  
 fine 8  
 fined 49  
 fish 5  
 fishing rod 29  
 flippers 29  
 float 22  
 flood 34  
 floorboard 28  
 floppy disk 20  
 flowerpot 6  
 folder 20  
 follow 59  
 for 43  
 force 16  
 forenames 32  
 fortunately 58  
 freckles 37  
 free range 54  
 French windows 6  
 friendship 30  
 fringe 37  
 frog 23  
 from 36  
 fruit machine 29  
 fuel 54  
 full-time 13  
 furry 33

## G

gangs 8  
 gazelle 23  
 gear stick 35

generous 2  
 gentle 7  
 get by 46  
 get on 11  
 get out of 26  
 get over 3  
 get worse 42  
 ghost 57  
 gigantic 7  
 go off 46  
 go on 46  
 golf club 29  
 gradual 7  
 graffiti 8  
 grate 10  
 grateful 2  
 greenhouse 6  
 grow 60  
 guessed 49  
 guest 49

## H

hair clip 24  
 hair spray 24  
 hand brake 35  
 hand cream 21  
 handbag 28  
 handmade 30  
 hang up 3  
 happily 58  
 hard 59  
 hardly 58  
 harmless 53  
 hat stand 18  
 haunted 55  
 headache 24  
 headlight 35  
 headphones 24  
 heat 10  
 heavily 51  
 hedge 6  
 hedgehog 23  
 heels 25  
 helicopter 44  
 hem 25  
 higher 49  
 hijack 34  
 hire 49  
 hold up 46  
 honest 2

hood 25  
 hook 18  
 hooligans 8  
 horn 35  
 hose 6  
 hug 15  
 humid 33  
 hurricane 34

## I

icon 20  
 immature 17  
 immigration officer 31  
 immoral 17  
 impatient 17  
 impolite 17  
 importance 30  
 impossible 17  
 impractical 17  
 improve 26  
 in 36  
 include 50  
 incorrect 17  
 increase 42  
 independent 2  
 index 47  
 indicator 35  
 industrious 41  
 inexpensive 17  
 inform 14  
 informal 17  
 information 30  
 ink 32  
 insensitive 17  
 insult 14  
 intend 38  
 intentional 45  
 interest 56  
 interrupt 14  
 interview 13  
 invent 41  
 invention 30

## J

jazz 48  
 jealous 2  
 judge 8  
 juicy 33  
 jukebox 29

## K

keen 7  
 keep on 3  
 key 20  
 key ring 28  
 keyboard 20  
 kidnap 34  
 kiss 52  
 knee pads 29  
 knickers 48  
 knock out 3  
 knot 49  
 knowledge 53

## L

laces 25  
 land 31  
 landing 18  
 laptop 20  
 lately 51  
 laundry basket 28  
 lawn 6  
 lawyer 9  
 lead 22  
 leadership 30  
 left 11  
 length 32  
 leopard 23  
 let down 3  
 letters 31  
 letterbox 6  
 lie 41  
 lifeguard 9  
 light bulb 1  
 light-hearted 7  
 lightning 34  
 lips 4  
 lipstick 21  
 lively 2  
 lizard 23  
 loathe 42  
 lorry 44  
 lose 60  
 lower 50  
 luckily 51  
 lucky 7

## M

mad 45  
 magazines 31

magician 53  
 make 31  
 malls 52  
 manage 50  
 manual 47  
 map 47  
 march 22  
 mark 31  
 mascara 21  
 massive 33  
 match 41  
 mature 2  
 meals 31  
 measure 31  
 meat 59  
 middle-parting 37  
 milk 5  
 mineral water 5  
 minute 33  
 mirror 35  
 miserable 2  
 mix 10  
 model 9  
 money 59  
 mood 57  
 moody 19  
 mop 18  
 mosquito 23  
 motorbike 44  
 moustache 37  
 mugged 8  
 music 48  
 mystery 34

## N

nail file 24  
 nail varnish 24  
 narrow-minded 7  
 nationality 32  
 navy 33  
 net 29  
 newspaper 28  
 normally 58  
 nose stud 37  
 nosy 19  
 not 49  
 notice 50  
 notice board 28  
 number plate 35

## O

obey 42  
 obstinate 19  
 occasionally 53  
 occupation 32  
 of 43  
 offend 16  
 offer 13  
 office 59  
 on 43  
 onion 12  
 only 11  
 open 60  
 opportunity 30  
 optimistic 7  
 organic 54  
 organize 22  
 organized 13  
 ostrich 48  
 oval 33

## P

pack 22  
 padlock 18  
 painful 55  
 painting 31  
 parcels 31  
 parking lot 39  
 part-time 13  
 passports 31  
 past 59  
 pathetic 45  
 patient 2  
 patiently 51  
 patio 6  
 peace 49  
 peach 12  
 peel 10  
 penknife 28  
 pepper 12  
 perform 31  
 performance 30  
 permanent 32  
 persuade 14  
 pessimistic 7  
 pesticides 54  
 pick up 3  
 picnic basket 28  
 piece 49  
 pillow case 28

pilot 9  
 plait 37  
 plane 44  
 plaster 21  
 plastic 48  
 plate rack 18  
 platform 11  
 playing cards 29  
 plays 31  
 pleasure 53  
 plenty 22  
 plum 12  
 pocket 25  
 poisonous 55  
 polluted 54  
 pony tail 37  
 popular 2  
 ports 52  
 possibility 30  
 potato peeler 1  
 potatoes 5  
 powder 57  
 praise 42  
 presents 14  
 pretend 16  
 proud 2  
 prove 38  
 public transport 54  
 punctual 26  
 purpose 32  
 put off 3  
 put out 3  
 put up 11

## Q

qualifications 13  
 quality 30  
 quantity 30

## R

rational 7  
 real 7  
 realize 50  
 receipt 41  
 recipe book 47  
 recognize 38  
 record 31  
 recover 22  
 rectangular 33  
 reduce 50  
 references 13

refuse 42  
 refuse collector 31  
 register 47  
 regret 11  
 relationship 30  
 relax 15  
 relaxed 2  
 reliable 2  
 remind 14  
 rescue 50  
 rest 15  
 restroom 39  
 revolting 45  
 reward 52  
 ripe 33  
 roast 10  
 robber 3  
 rocket 44  
 roll 60  
 romantic novel 47  
 roof rack 28  
 rope 18  
 rose 49  
 rough 33  
 round trip 39  
 row 22  
 rows 49  
 rubbish 31  
 ruin 50  
 run 60  
 run out of 3  
 rush 22

## S

safety pin 28  
 salmon 23  
 sardine 48  
 satellite dish 6  
 satisfied 59  
 save 11  
 scar 37  
 scooter 44  
 scorpion 23  
 scratch 15  
 scream 15  
 seal 23  
 search 22  
 seatbelt 35  
 self-confident 19  
 sense of humour 13

sensible 2  
 sensitive 7  
 separate 16  
 serious 7  
 seriously 51  
 serve 31  
 set out 3  
 sew 49  
 sex 32  
 shampoo 21  
 shape 56  
 share 16  
 shaved 37  
 shoe polish 24  
 shoelace 24  
 shoplifting 8  
 shore 49  
 show off 3  
 side-parting 37  
 sidewalk 39  
 signature 32  
 silk 48  
 singer 31  
 sink 22  
 situation 30  
 ski stick 29  
 skills 13  
 sleeping bag 28  
 sleeve 25  
 slice 10  
 smart 59  
 smile 52  
 smooth 33  
 sneeze 15  
 snore 15  
 snorkel 29  
 so 49  
 solve 38  
 songs 31  
 speech therapist 9  
 speeding 8  
 speedometer 35  
 spoil 50  
 spoilt 26  
 sponge bag 21  
 sports car 44  
 spots 37  
 spread 10  
 squeeze 10  
 stairs 49

stale 55  
 stamp 56  
 stand in line 39  
 stare 49  
 starting salary 13  
 starving 45  
 status 32  
 stay up 26  
 steak 5  
 steep 55  
 steering wheel 35  
 sticky 55  
 stir 10  
 stomach 4  
 stone 55  
 stop 26  
 strap 25  
 strength 53  
 stressful 13  
 strict 19  
 string 18  
 strip light 18  
 stubble 37  
 study 52  
 submarine 44  
 subway 39  
 succeed 50  
 sudden 7  
 suitcase 1  
 sun cream 24  
 sunglasses 24  
 superficial 2  
 superstitious 41  
 support 11  
 suppose 38  
 sure 49  
 surgeon 9  
 surname 32  
 surveyor 31  
 swan 23  
 swap 50  
 sympathetic 19

## T

table tennis bat 29  
 take away 31  
 take off 3  
 take up 46  
 talcum powder 21  
 talented 19

tangerine 12  
 tap 6  
 tarantula 23  
 tasty 59  
 tattoo 37  
 tea 5  
 tea towel 1  
 tease 38  
 telephone directory 24  
 telephone number 24  
 tell 60  
 tell off 3  
 temporary 13  
 terrify 38  
 theft 8  
 thermometer 18  
 thick-skinned 7  
 throat 4  
 thumb 4  
 tie 57  
 timetable 47  
 timid 19  
 tiny 7  
 tip 56  
 title 32  
 to 36  
 tomatoes 5  
 toothbrush 24  
 toothpaste 24  
 tortoise 23  
 tractor 44  
 traffic 54  
 train 22  
 training course 13  
 translate 14  
 trash 39  
 tray 1  
 treat 31  
 triangular 33  
 trust 38  
 tuna 23  
 turkey 23  
 turn down 46  
 turn up 3  
 twist 60  
 tyre 35

U

unattractive 17  
 under 43



## WORD LIST

underwear 25  
unemployed 11  
unemployment 30  
unexpectedly 58  
unfashionable 17  
unfortunately 53  
unhealthy 17  
uniform 25  
uninterested 7  
uninteresting 17  
unlucky 7  
unmarried 59  
unnatural 53  
unpleasant 17  
unpopular 17  
unusual 17  
urgent 55

## V

van 44  
vanish 42  
veal 54  
vest 25  
violence 8

violent 19  
violently 58  
virus 20  
visas 31  
V-necked 55  
volcano 34

## W

waist 4  
waistcoat 25  
wait 49  
waiter 31  
wallpaper 28  
warm 2  
warn 14  
website 20  
weep 15  
weight 49  
weights 29  
weird 2  
well 48  
well-known 55  
well-paid 13  
wet 48

whale 23  
wheel 35  
whip 10  
whisper 14  
wicked 59  
wildlife 54  
win 60  
windscreen 35  
windscreen wipers 35  
wine 5  
wish 38  
with 43  
work out 46  
wrinkles 37  
wrist 4  
wrong 52

## Y

yacht 44

## Z

zip 25