

# Play Games with English

## Word Games for English

### English Puzzles

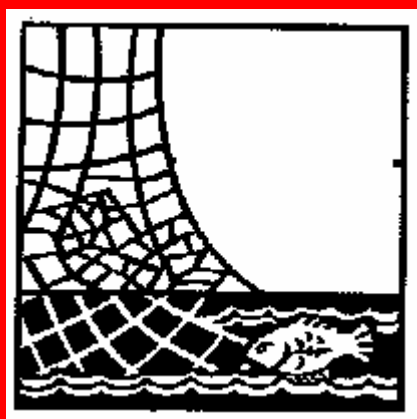

**1** **Word**

**Games**  
**for**  
**English**

# Word games for English

(1-3)

# CONTENTS

## WORKSHEETS

1. A Picnic in the Country
2. Abbreviations 3
3. Abbreviations
4. At The Hotel
5. At the Station
6. Circle Game
7. Doubles1
8. Free Time
9. Help
10. Legs
11. Map Reading
12. New House
13. Opposites 1
14. Opposites 4
15. Plurals
16. Shopping List 1
17. Shopping List 2
18. Sports
19. The Application Form
20. The New House
21. Verb Game1
22. What's the Matter
23. Where
24. Who
25. XWord 1 Colours
26. XWord 4
27. Body Talk
28. Books
29. Card game for Prepositions
30. Clothes
31. Doubles
32. Make And Do
33. Money
34. Odd One Out 1
35. Odd One Out 3
36. Odd One Out 4
37. OO and EE
38. The Family Tree
39. The Word Snail
40. The Word Snake
41. Time Off
42. Words Beginning With -CAR
43. \_Words Easily Confused
44. As - As\_
45. British and American English
46. Crime and Punishment (Xword)
47. Cross It Out (Colours)
48. Food For Thought
49. Four Of A Kind
50. Get Well Soon
51. Glidogram 2
52. Headlines
53. Leisure And Pleasure
54. Links
55. Living World (animals)
56. Pairs
57. Politics
58. Prefixes And Suffixes
59. \_Prepositional Phrases
60. Rainbow
61. Sort It Out
62. Sort Them Out
63. Statistics
64. Train of Thought
65. Travel Brochure (part 1)
66. Travel Brochure (part 2)
67. Verb Gimnastics
68. Verb Pieces
69. What's it for
70. What's On TV (part 1)
71. What's On TV (part 2)
72. ANSWERS

# A Picnic in the Country

Look at this busy scene in the country. What are people doing?  
Answer with TRUE or FALSE.



For example:

1. Someone's reading.
2. Someone's swimming.
3. Someone's driving.
4. Someone's climbing.
5. Someone's drinking.
6. Someone's riding.
7. Someone's resting.
8. Someone's fighting.
9. Someone's jumping.
10. Someone's sewing.

True	False
X	
	X



11. Someone's crying.
12. Someone's shaving.
13. Someone's hurrying.
14. Someone's laughing.
15. Someone's hiding.
16. Someone's standing.
17. Someone's leaving.
18. Someone's shooting.
19. Someone's watching.
20. Someone's running.

True	False



# ABBREVIATIONS 3

Do you understand these abbreviations? Write them out in full

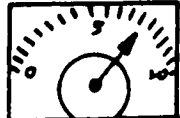
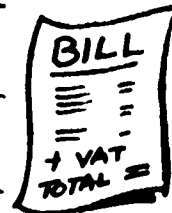
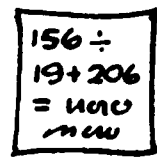
For example:

	BA <u>Bachelor of Arts</u>			
	MA _____		max. _____	
	Ph.D. _____		min. _____	
	Dip. _____		VAT _____	
	Prof. _____		vol. _____	
Univ. _____		maths. _____		

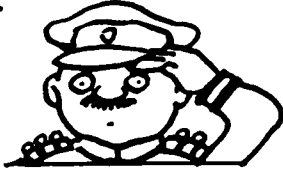
Bachelor of Arts   Limited   minimum   Headquarters   volume  
 Value Added Tax   miles per gallon   Professor   maximum  
 European Union   Captain  
 Company   mathematics   Doctor of Philosophy   England   Diploma  
 government   miles per hour   Master of Arts   University   British Airways

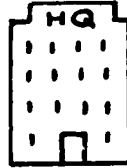
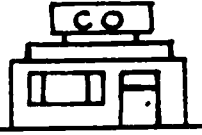
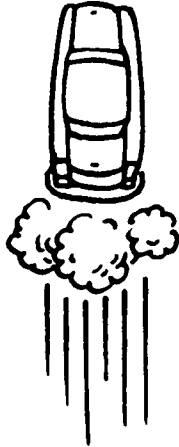
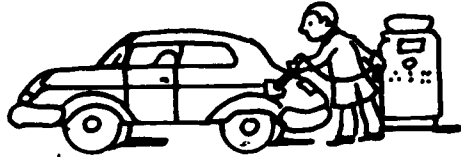
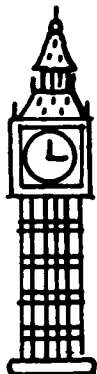
				
BA _____		Eng. _____		
	Capt. _____	govt. _____	HQ _____	
		Ltd. _____	Co. _____	
m.p.h. _____		EU _____		
m.p.g. _____				

# ABBREVIATIONS 1

Can you find the correct abbreviations?

For example:

a.m.	ante meridiem (in the morning)
	Great Britain
	pound (weight)
	United States
	please turn over
	metre
	Sunday
	Friday
	north
	Monday
	post meridiem (in the afternoon)
	United States of America
	Saturday
	northeast
	kilometre
	United Kingdom
	Union of Soviet Socialist Republics
	kilogram
	United Nations



# AT THE HOTEL

Look at the list. Can you give each service its name?

## THE RITZ HOTEL: OUR SERVICES FOR GUESTS

For example:

1 BREAKFAST



from 6.30 a.m. to 10.30 a.m.

2 \_\_\_\_\_



open for lunch and dinner

3 \_\_\_\_\_



for drinks till 11.30 p.m.

4 \_\_\_\_\_



dial '0' for Reception

5 \_\_\_\_\_

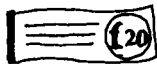

for Traveller's Cheques only

6 \_\_\_\_\_



in Emergency ask at Reception

7 \_\_\_\_\_



in every room

8 \_\_\_\_\_



in double rooms only

9 \_\_\_\_\_



free for guests' cars

10 \_\_\_\_\_



at 12.00 (midday)

11 \_\_\_\_\_



can be guests too for £1 a day

12 \_\_\_\_\_



tell us the night before

Breakfast    Television    Dogs    Change    Restaurant  
Bar    Check-out    Doctor    Radio    Wake-up  
Telephone    Parking



# AT THE STATION

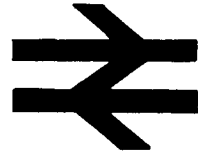

Taxis    Waiting Room    Bar    Danger  
Way Out    Platform 1    Closed

Can you put each sign in its correct place?

For example: 1 = Taxis

When you've finished, close the book and write down all the signs you can remember.

(There are 13.)



Ticket Office      Lost Property Office      Toilets  
Open      Travel Centre      Telephone

# CIRCLE GAME

Find the object and then find the correct verb.

For example: pay a bill

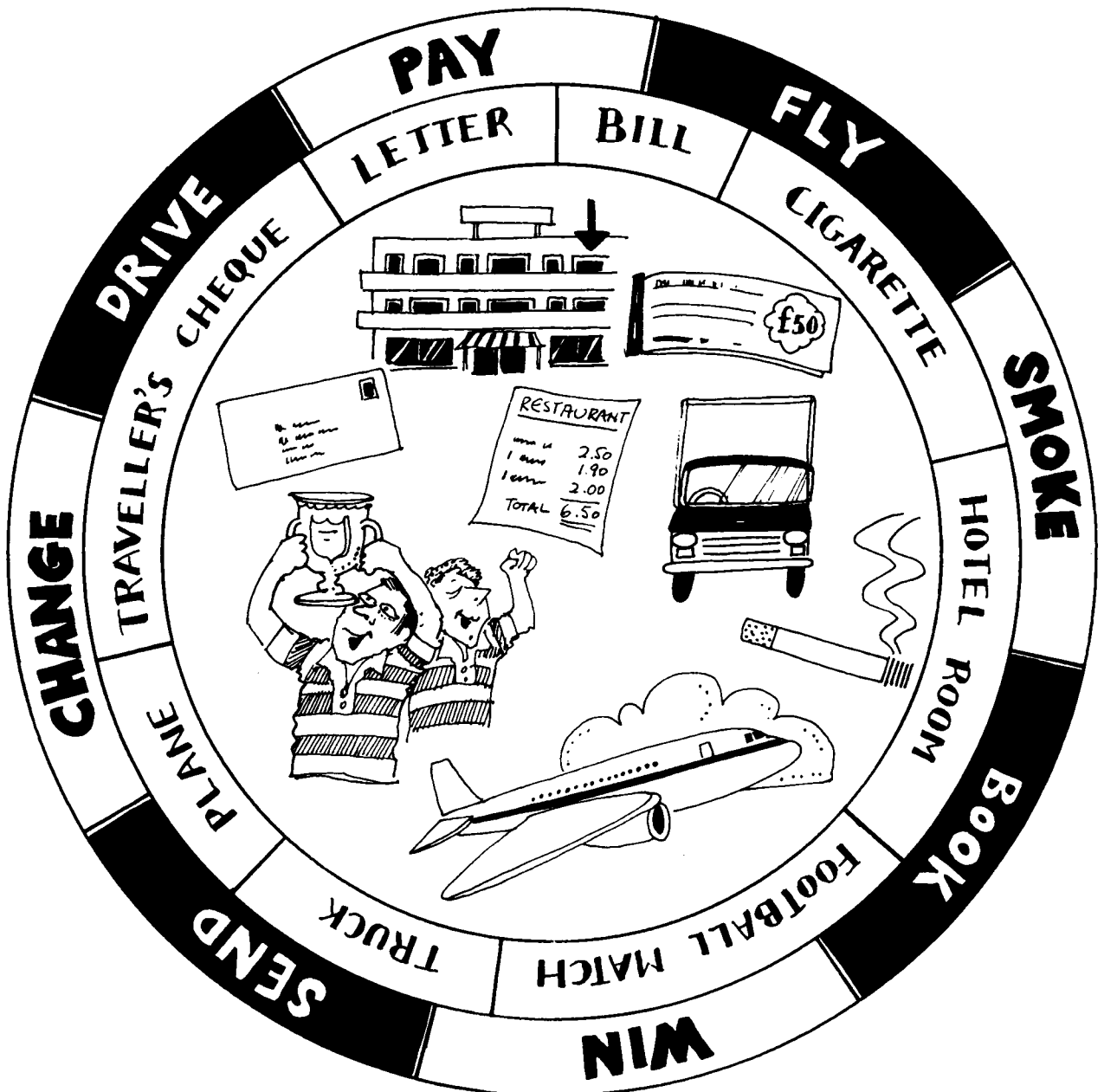

# doubles 1

Many words in English are made of two words.

Put the word from list A with the correct word from list B.

For example: FIRST NAME

Caroline Macdonald

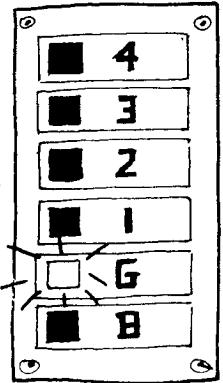

555 2505

- A**
- FIRST
  - DEPARTURE
  - TELEPHONE
  - BUS
  - CAMPING
  - SHOPPING
  - ORANGE
  - GROUND
  - TELEPHONE

- B**
- JUICE
  - FLOOR
  - SITE
  - LOUNGE
  - BOX
  - STATION
  - NUMBER
  - NAME
  - LIST

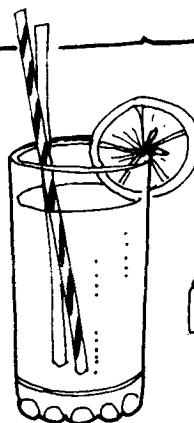
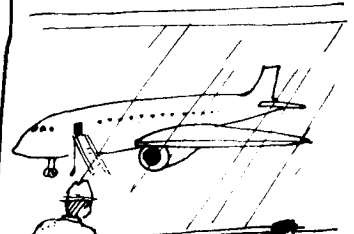

# Free Time

Mr Jones and Mrs Smith have many interests. Write two lists.

← For example →  
Mr. Jones dancing      Mrs. Smith walking

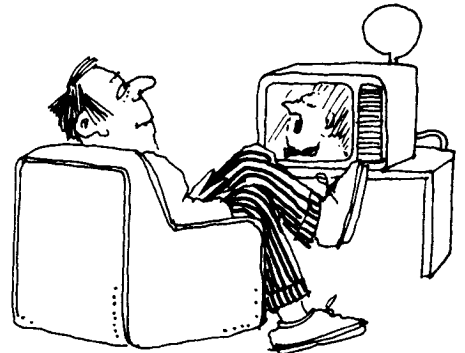
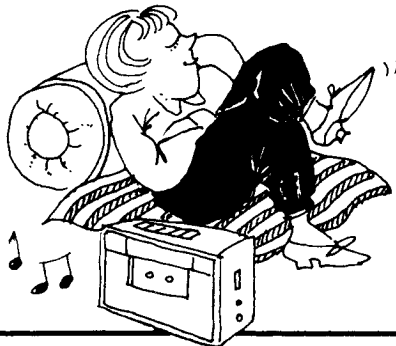
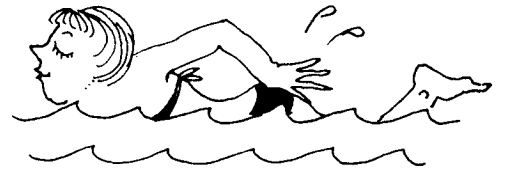
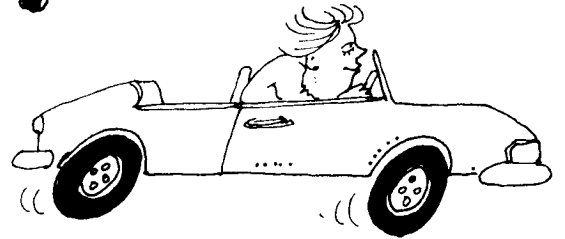

- dancing    walking    learning foreign languages  
driving    watching television    cooking    swimming  
playing football    reading    listening to music

# HELP 1

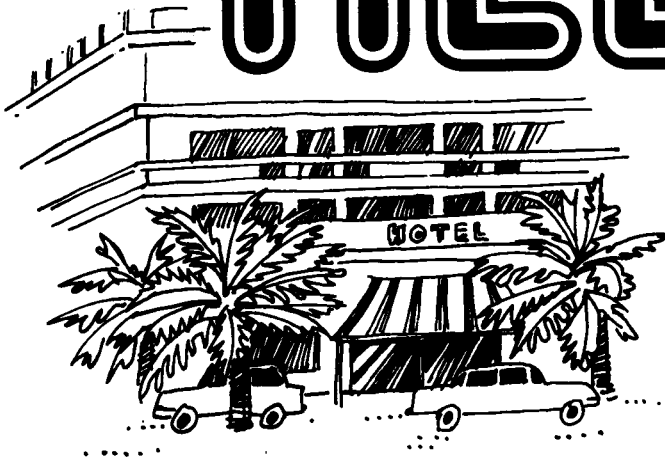

Jack and Sally are staying at the same hotel. He is on holiday and she is a journalist. Today he is going to the beach and she is working. Can you say what is his and what is hers?

For example: HERS - money  
HIS - ball

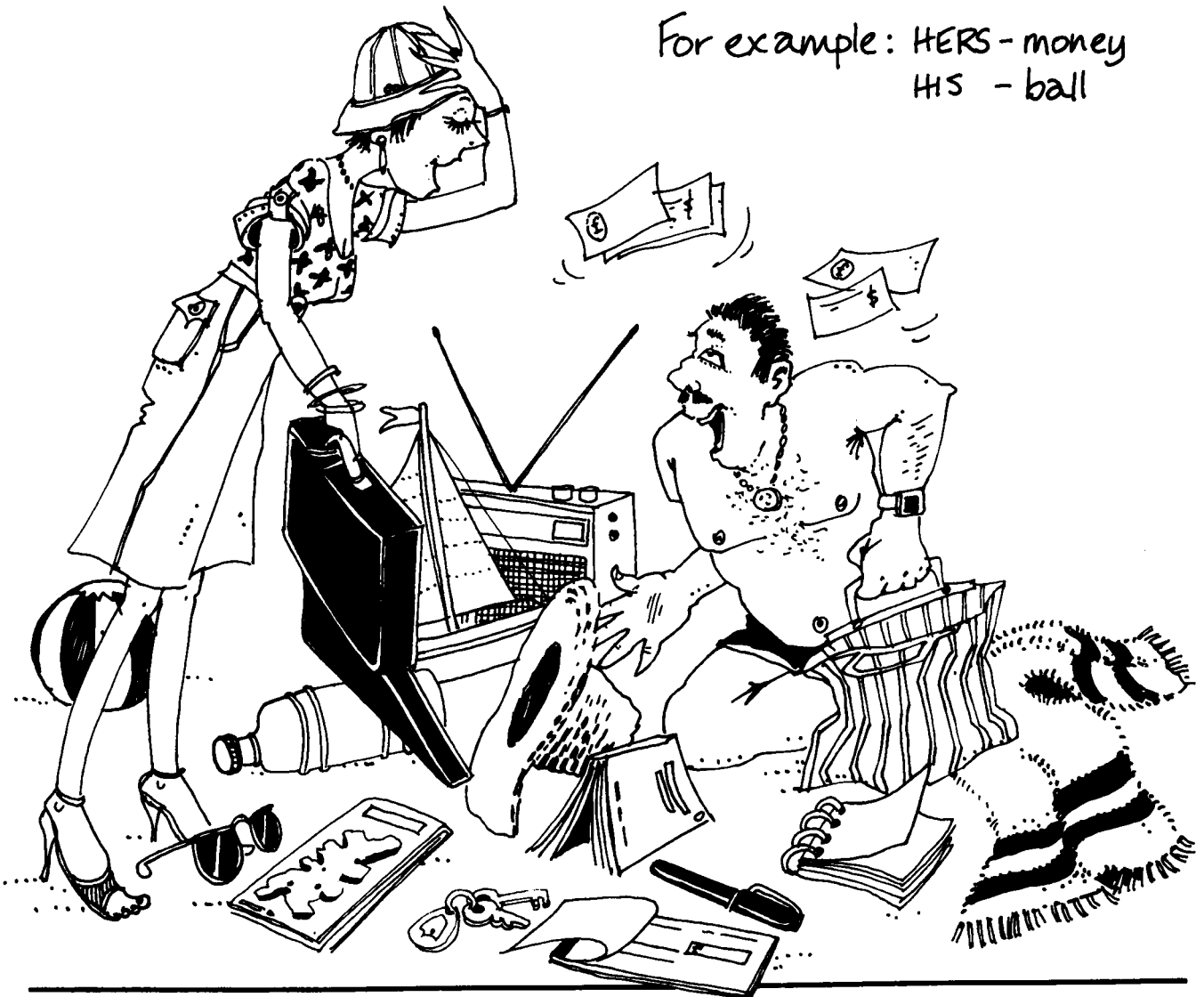

money ball bottle of water map boat  
book car keys notebook sunglasses  
pen towel hat cheque book radio

# - LEGS -

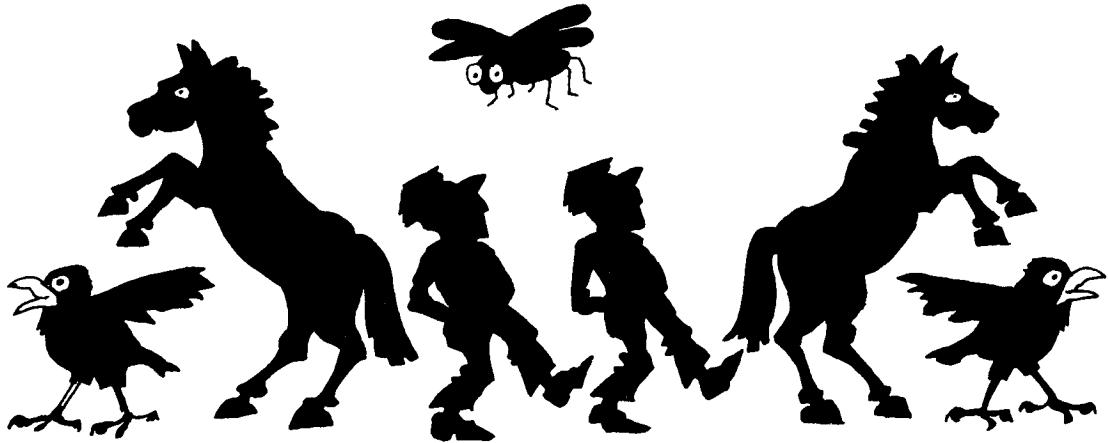

Count the number of legs

For example:

Three dogs	twelve	Legs 12
Four cats		Legs
One farmer & two horses		Legs
One bird		Legs
One fly		Legs
One tourist guide & fourteen tourists		Legs
Two chairs		Legs
Four tables		Legs
Mr & Mrs Brown & their three daughters		Legs
Total		Legs

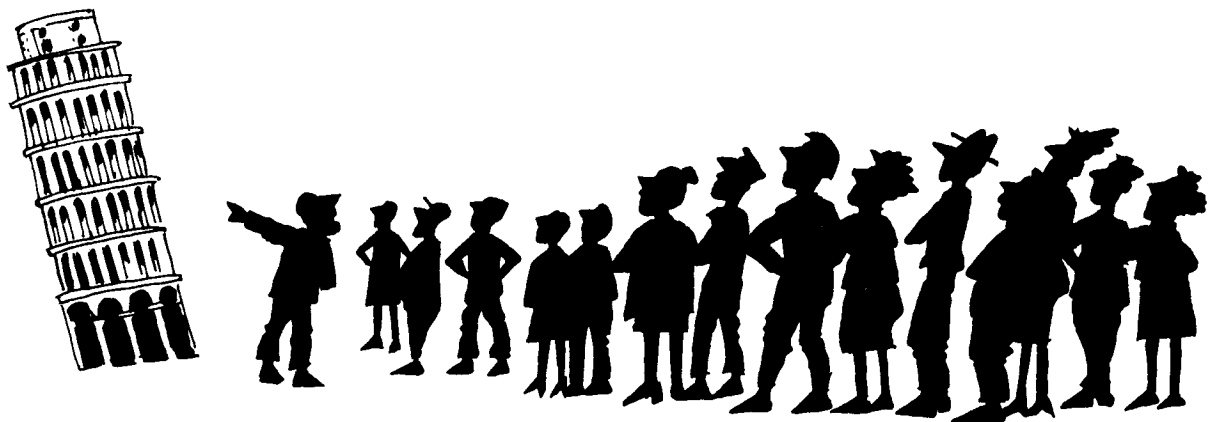

If you are right, the total is the same as the number of legs in five football teams.

# Map Reading

Look at the map. What do the symbols represent?  
Complete the key.

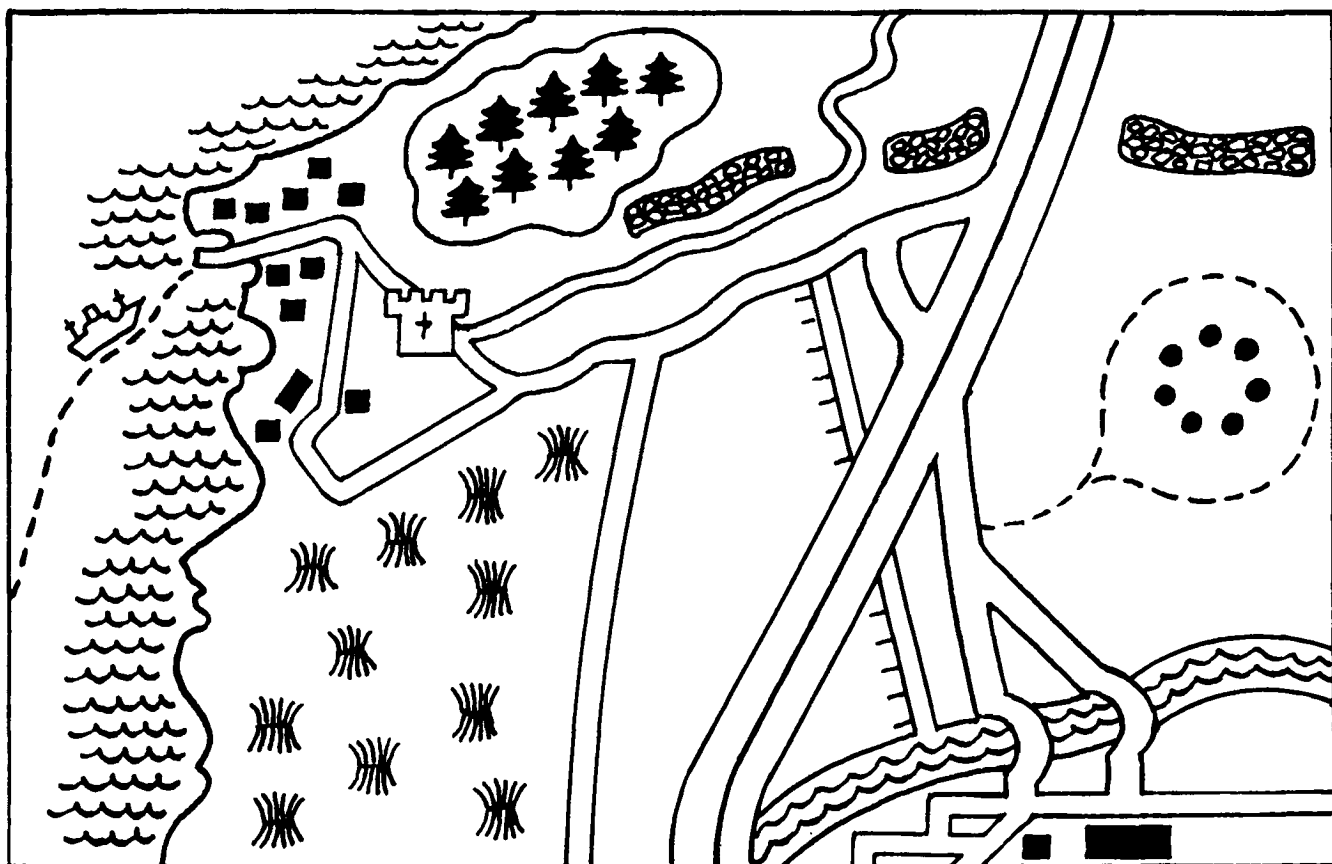

KEY

For example: 1. canal		5.		9.	
2.		6.		10.	
3.		7.		11.	
4.		8.		12.	

canal farmland motorway footpath coast old wall  
ferry stone circle village forest bridge castle



# The New House

Mr and Mrs Williams have a new house.  
Can you help them put everything in its right place?  
Make one list for the kitchen and one for the bedroom.

For example: KITCHEN      BEDROOM  
cup                      sheet

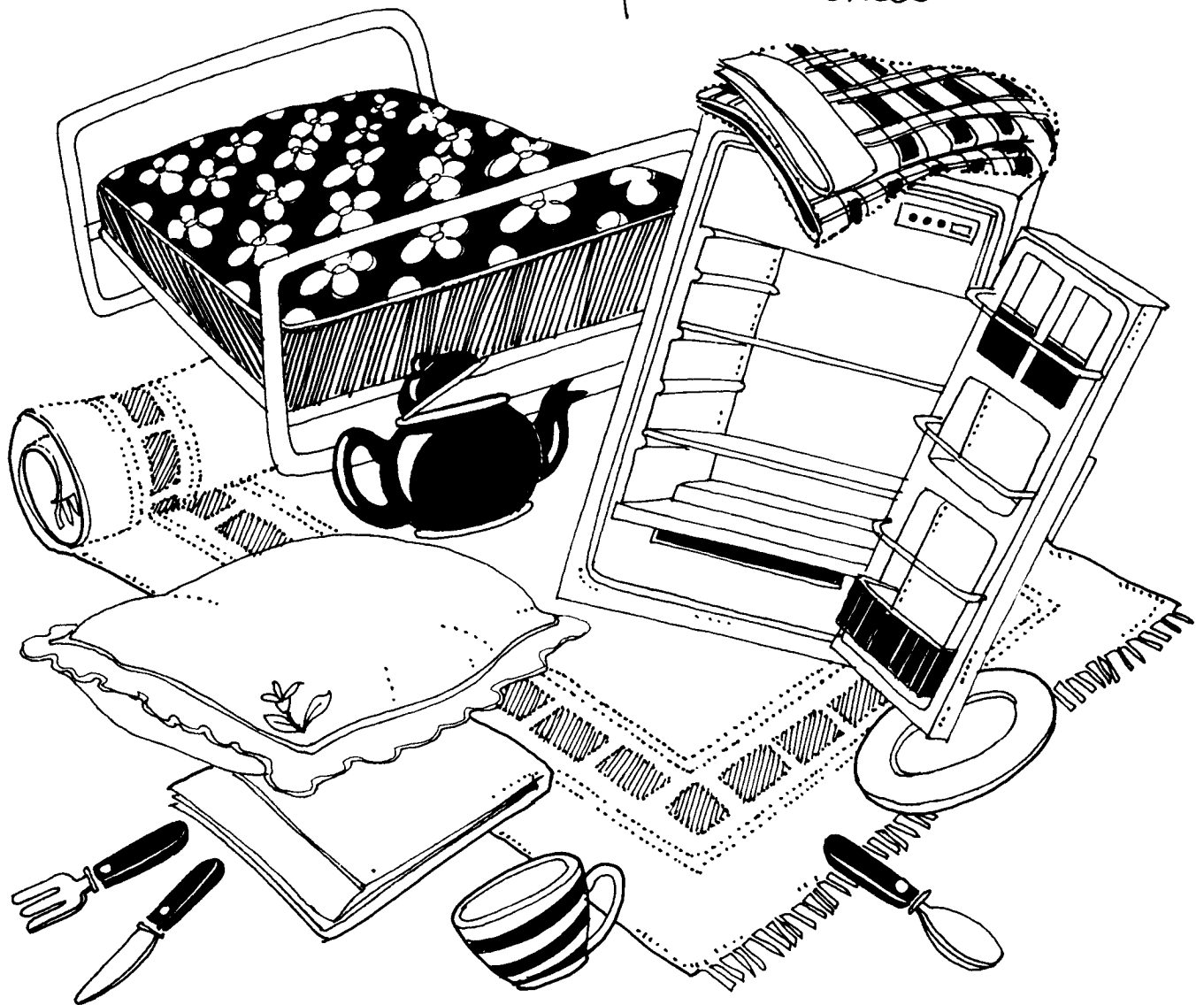

cup    sheet    carpet    fork    bed    knife  
plate    fridge    blanket    spoon    pillow    teapot

# Opposites 1

Here are 7 pairs of adjectives.  
Can you find the correct pictures?  
Write the numbers beside the words.

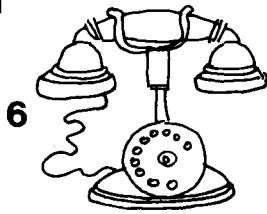
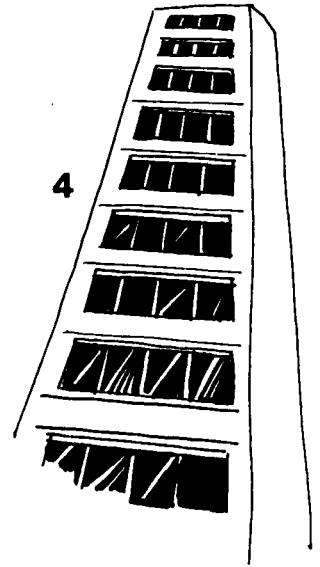
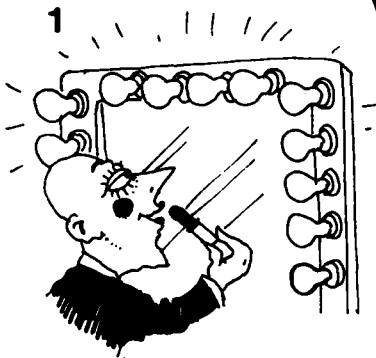

For example:

9	Dark	Light	1
	Cheap	Expensive	
	Quiet	Noisy	
	High	Low	
	Old	New	
	Young	Old	
	Heavy	Light	

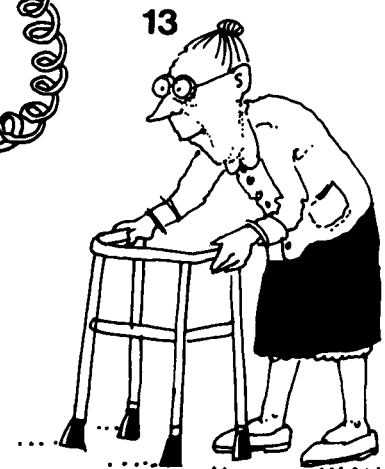
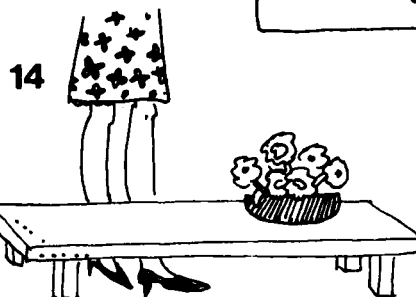
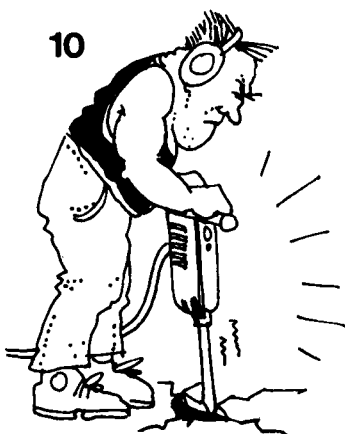
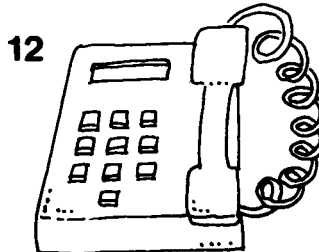
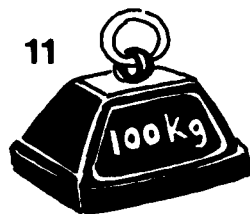

I like it. It's .....

# opposites

I don't like it. It's .....

## 4

For example:

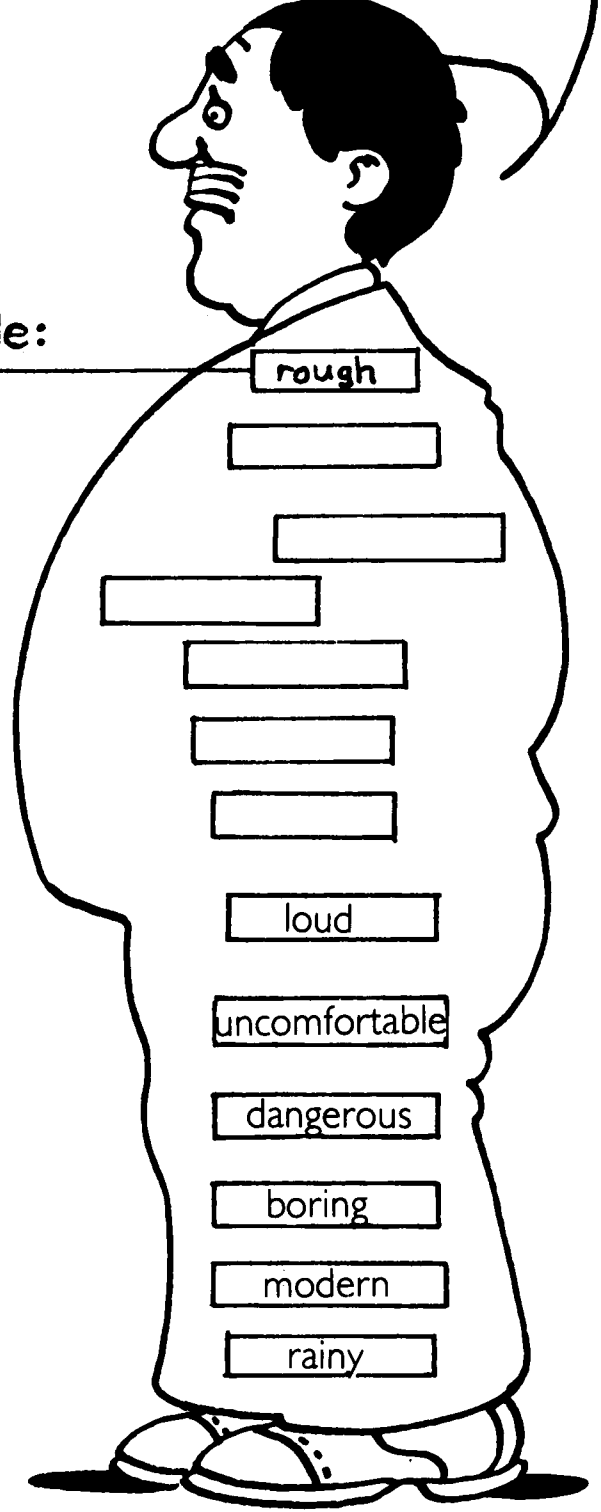
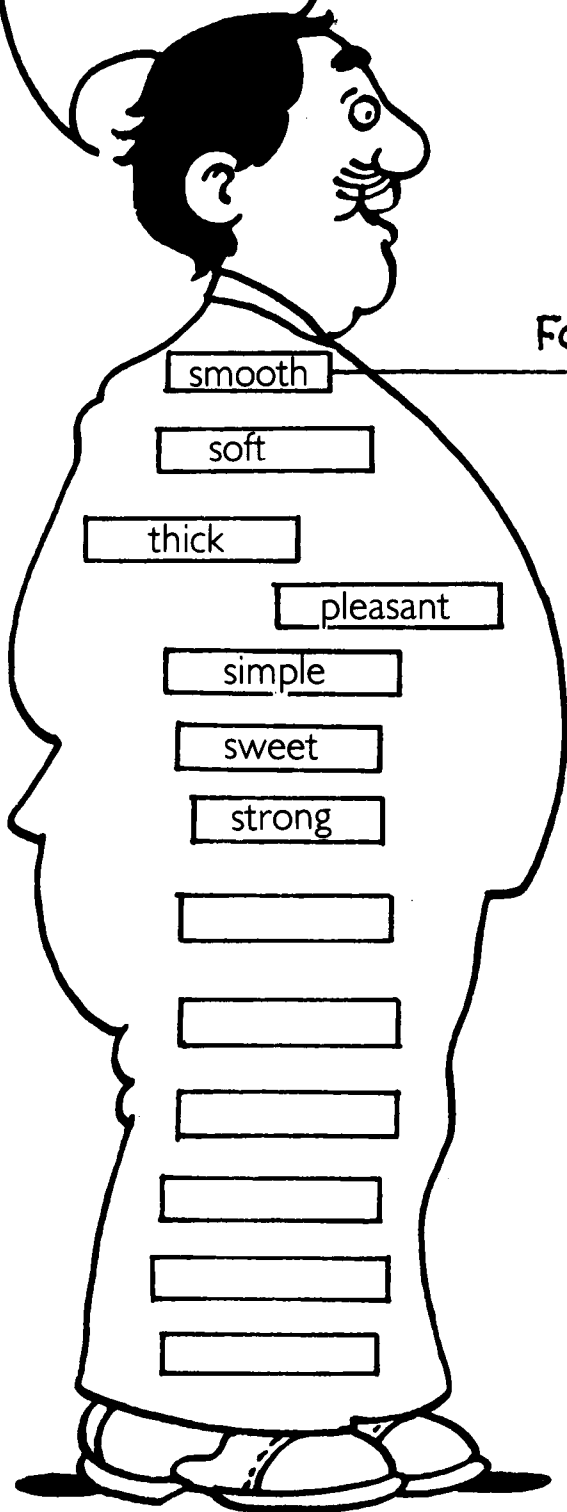

rough interesting hard thin weak bitter fine  
 difficult unpleasant safe comfortable soft antique

# Plurals

Look at the singular form and write the plural.

For example: 1 woman

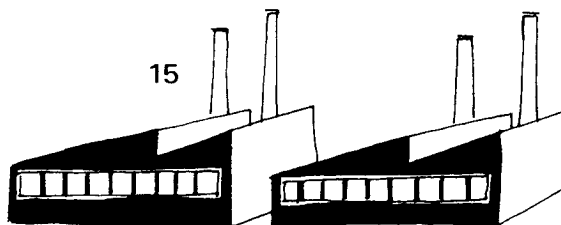
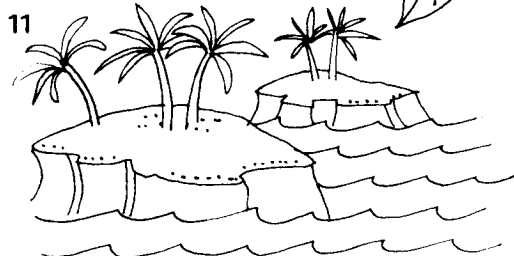
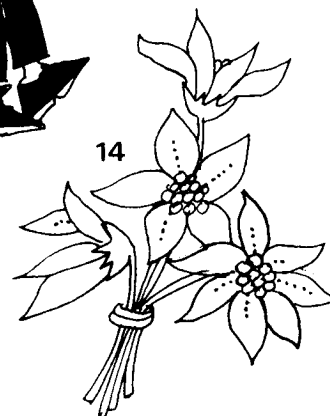
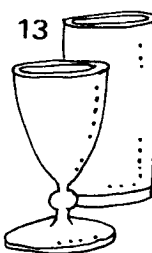
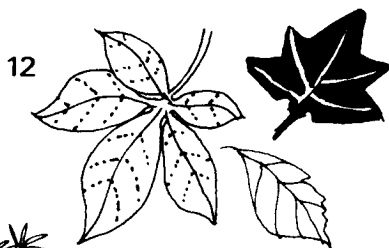
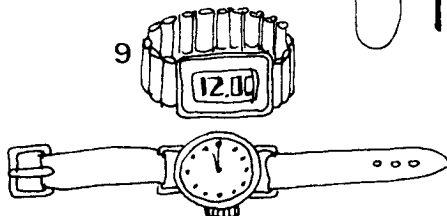
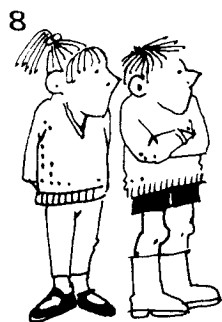
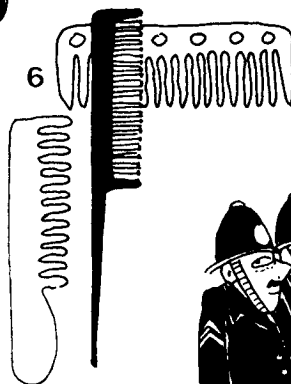
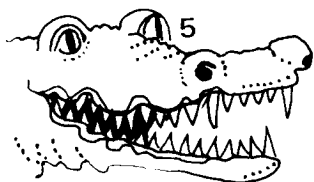
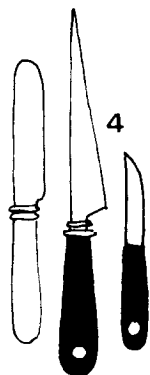
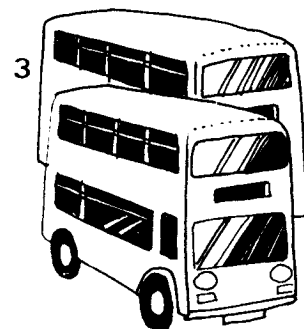
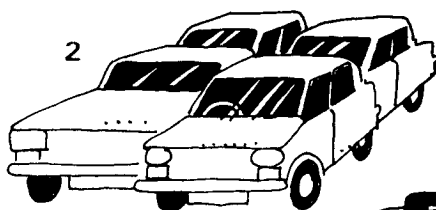

woman    tooth    leaf    comb    bus    foot    watch  
 flower    child    policeman    island    car    knife    glass  
 factory

# Shopping List 1

Look at the shopping. Put the list together.

For example: **POT** **ATOES** = potatoes

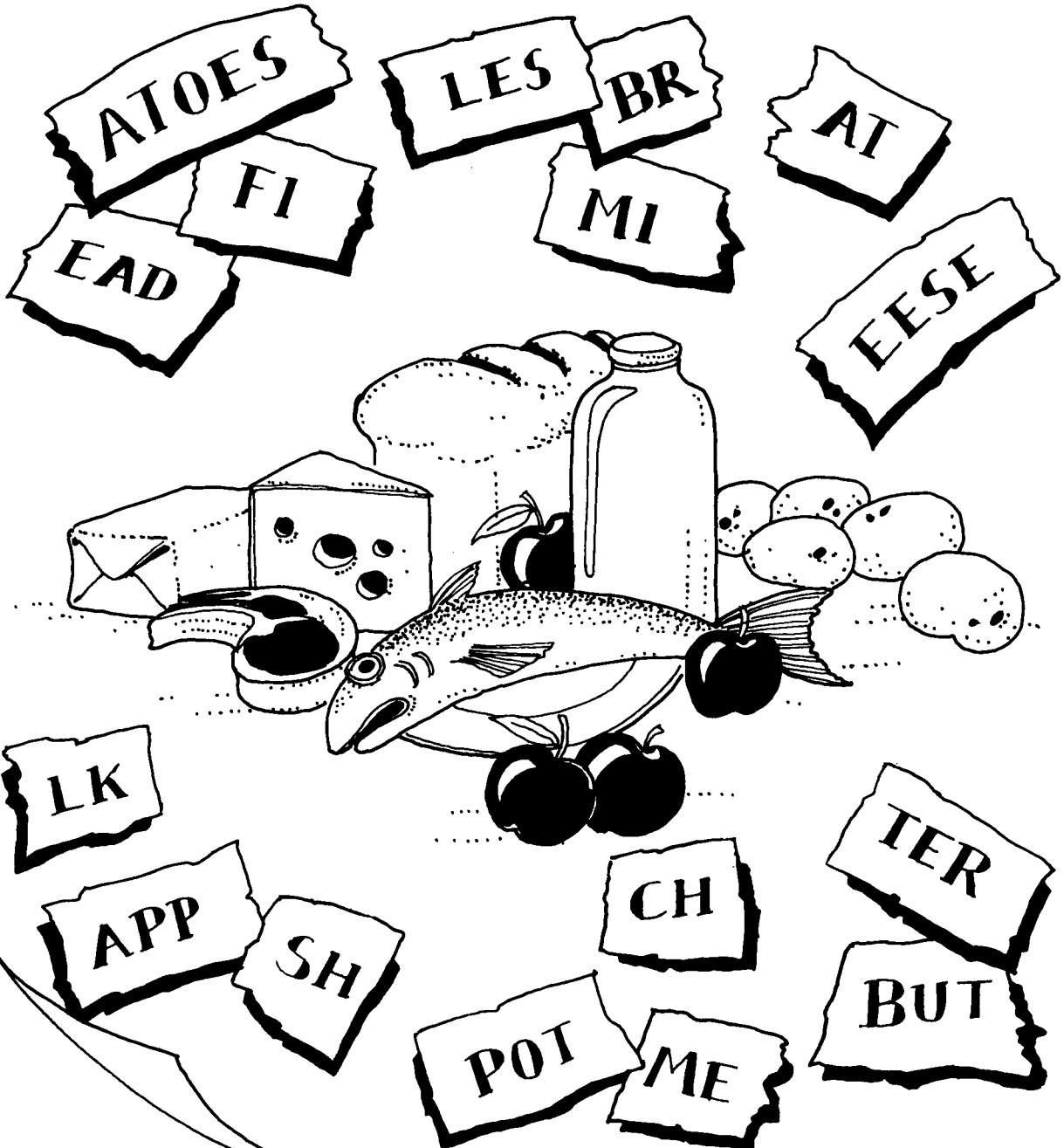

# Shopping List 2

Look at the shopping  
Mike has brought home.  
Write his list.

For example: 1 a kilo of beans

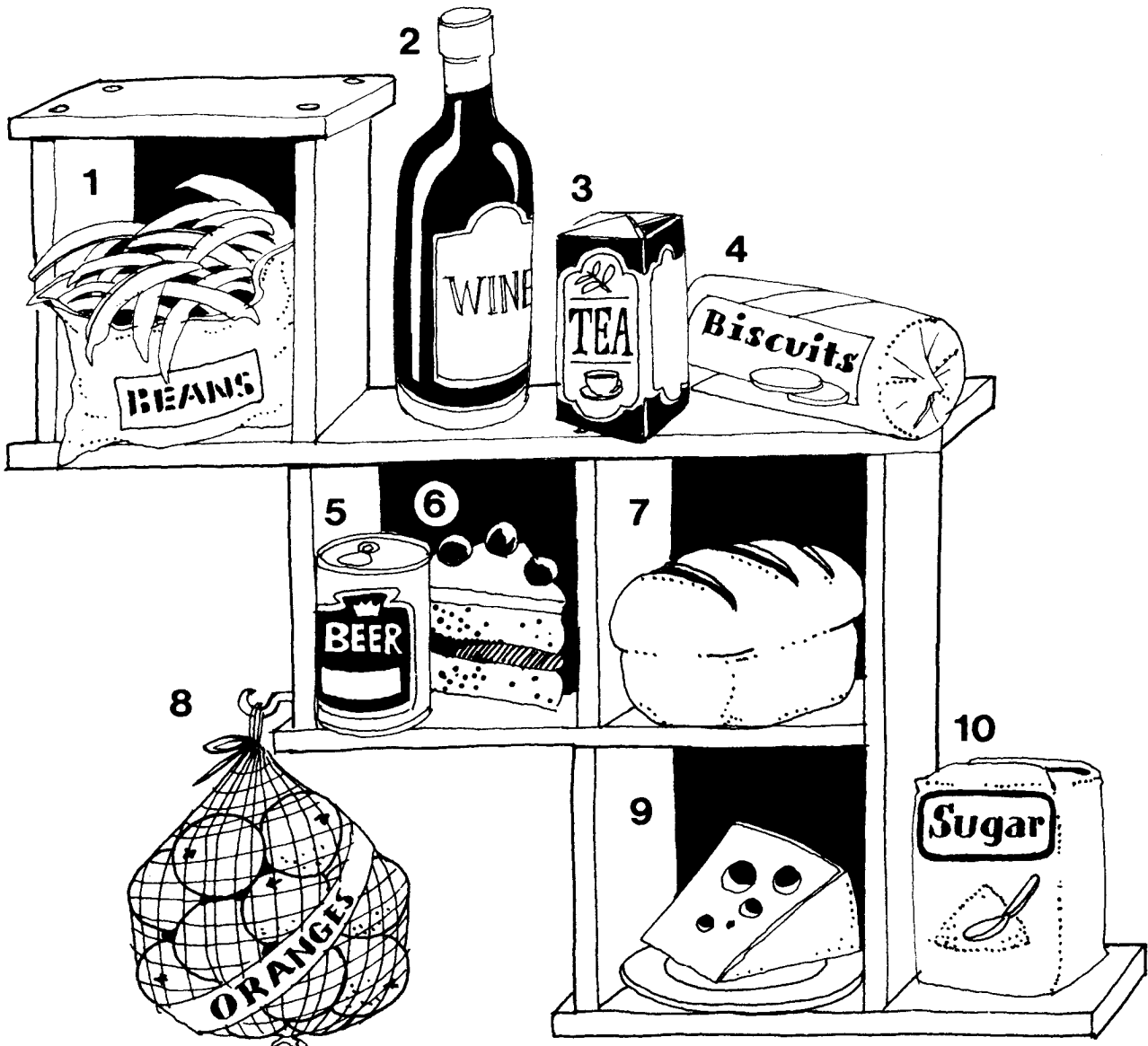

kilo    bottle    loaf    can    packet    piece



Can you name these sports and write them in the correct column?

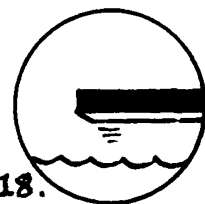
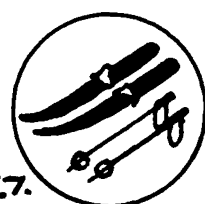
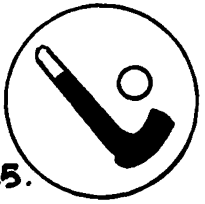
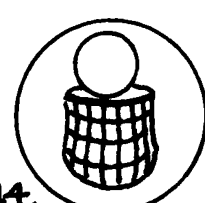
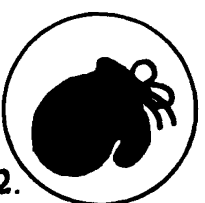
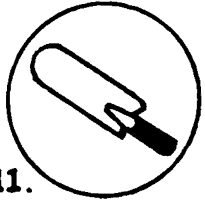
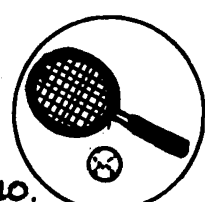
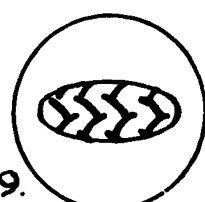
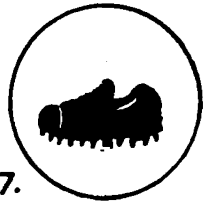
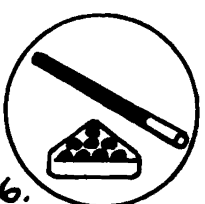
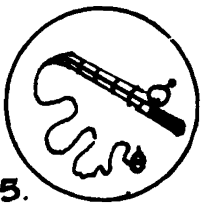
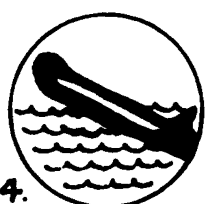
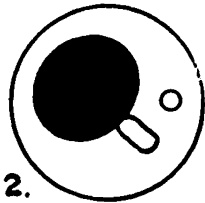
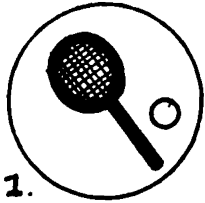

Individual usually done alone	Needs 2 or 4 people	Needs a team
	For example: 1. squash	

squash skiing boxing table tennis rugby tennis badminton  
basketball running hockey baseball water-skiing snooker  
fishing shooting diving ice skating cricket

# The Application Form

Jane Anderson has filled in this application for a new job. You have her answers. Can you finish the form?

APPLICATION FORM

Please type or write clearly.

For Example  
1. FAMILY NAME .Anderson..... 2. \_\_\_\_\_ Ms....

3. \_\_\_\_\_ .Jane. Irene.....

4. \_\_\_\_\_ 30<sup>th</sup> July. 1961... 5. \_\_\_\_\_ York...

6. \_\_\_\_\_ .Single..... 7. \_\_\_\_\_ None...

8. \_\_\_\_\_ 27. Glenhill Gardens. Richmond.....

9. \_\_\_\_\_ Surrey..... 9. \_\_\_\_\_ 584-22-01

10. \_\_\_\_\_ York. Girls' School. '72-'79.....

11. \_\_\_\_\_ Raydon. College of Art. '79.-'83.....

12. \_\_\_\_\_ Diploma in Art and Design. (DIP AD) '83

13. \_\_\_\_\_ Art and Craft Summer School (Assistant

14. \_\_\_\_\_ Teacher.) Spain. '83+'84.....

15. \_\_\_\_\_ Art. Department. J.Y.C. magazine

16. \_\_\_\_\_ £8.500 P.A. ....

17. \_\_\_\_\_ French and Spanish, German (a little)

18. \_\_\_\_\_ Yes.....

19. \_\_\_\_\_ Photography, Astronomy, Mountain

20. \_\_\_\_\_ Climbing.....

21. \_\_\_\_\_ Ignacia Ibañez. S. Warlock.....

22. \_\_\_\_\_ 430.5.4. Calle Muñoz. Art. Director...

23. \_\_\_\_\_ Tarragona, Spain.. 22 Bedhill Place.

24. \_\_\_\_\_ from January. 1<sup>st</sup>. '86.....

25. \_\_\_\_\_ Nov. 15<sup>th</sup>. '85. 21 \_\_\_\_\_

*Jane Anderson*

- Family name
- Interests
- Tel. no.
- Education: schools attended
- Signature
- Marital status
- Languages spoken
- Names and addresses of 2 referees
- First names
- Place of birth
- Education: university/college
- Mr/Mrs/Miss/Ms
- Date available
- Date
- Present address
- Children
- Driving licence
- Present position
- Date of birth
- Present salary
- Previous experience



# The New House

Mr and Mrs Williams have a new house.  
Can you help them put everything in its right place?  
Make one list for the kitchen and one for the bedroom.

For example:    KITCHEN    BEDROOM  
                         cup                                  sheet

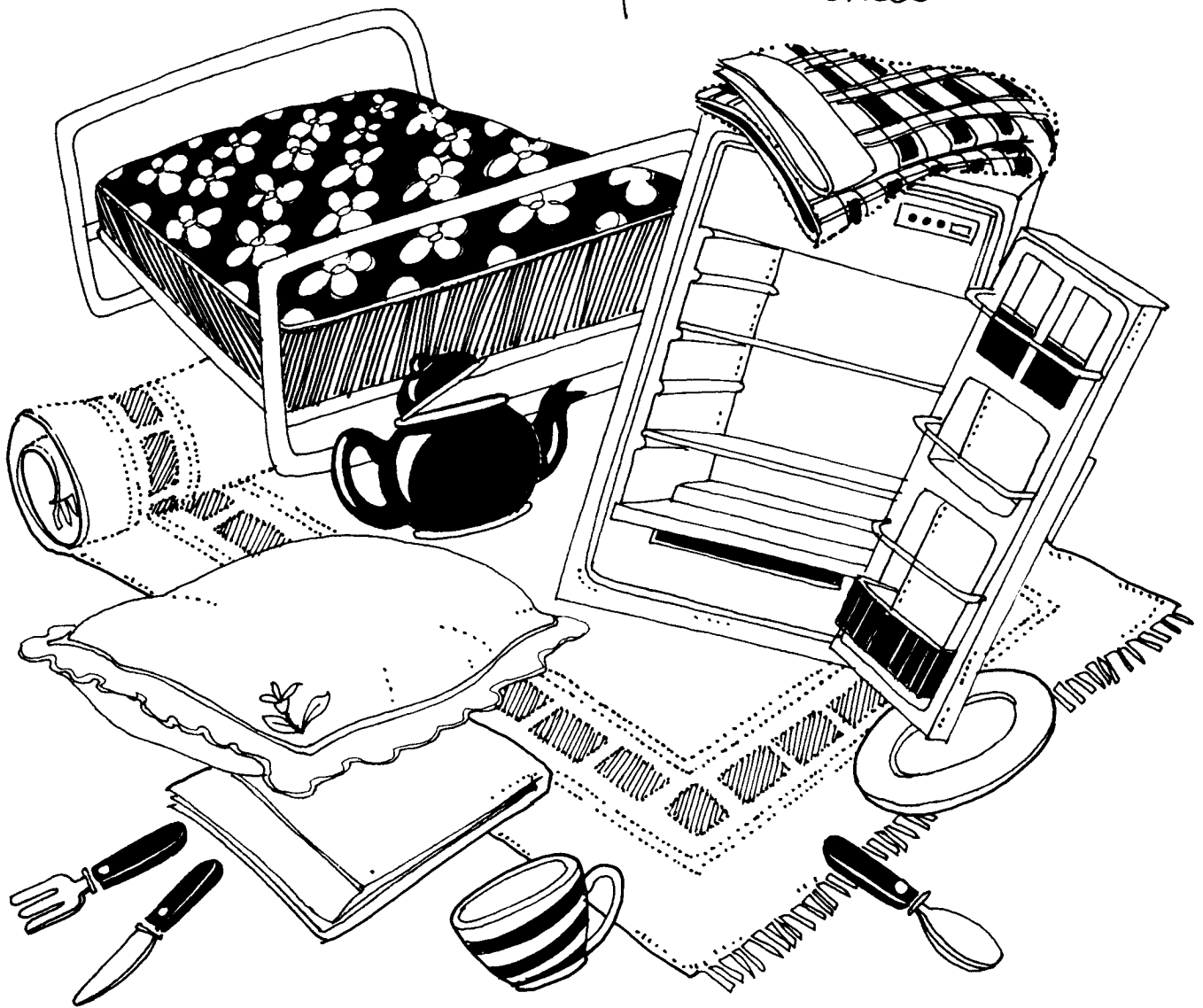

cup    sheet    carpet    fork    bed    knife  
plate    fridge    blanket    spoon    pillow    teapot

# VERB GAME 1

Can you find 10 verbs hidden in this square?

The pictures will help you.

Do this  or this .

For example:

R	T	T	F	S	L	I	N	R	O
P	O	H	L	I	I	F	S	H	E
V	E	I	G	Q	S	G	I	V	E
W	C	N	M	U	T	A	T	B	A
A	L	K	V	P	E	S	K	A	T
I	E	O	S	I	N	G	P	O	C
T	A	L	K	A	Z	I	M	E	H
D	N	S	Z	J	E	O	O	U	J
Q	A	P	V	T	K	S	T	O	P



# What's the matter?

Look at him . . . he's not happy, is he?  
Can you say why?  
Fill in the missing words.

For example: 1 He's tired.

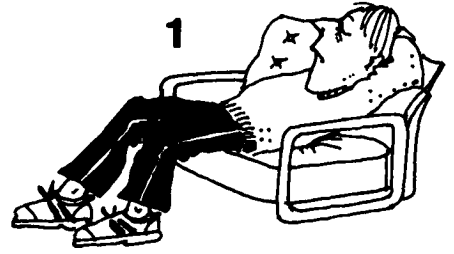

He's ..... on the .....



He's got a .....



He's .....



He's .....

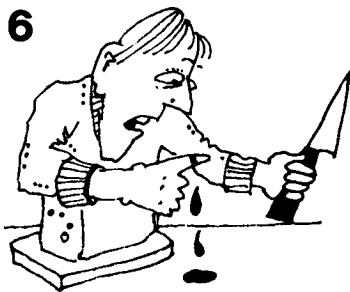

He's ..... his .....



He's ..... his .....



He's got a .....  
in his .....



He's ..... his .....

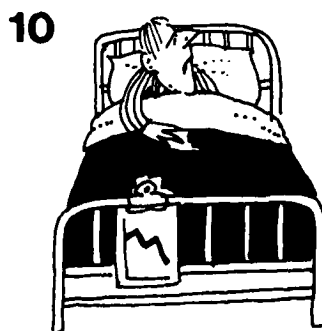

He's .....

tired    fallen    pain    ill    broken    ice    finger  
cold    thirsty    burnt    arm    hand    hungry  
cut    back

# WHERE?



Jane is phoning the Brown family.  
Where are they?

Hello, is Ann there please?



For example: **1** She's in the dining room.

2

And Tom?

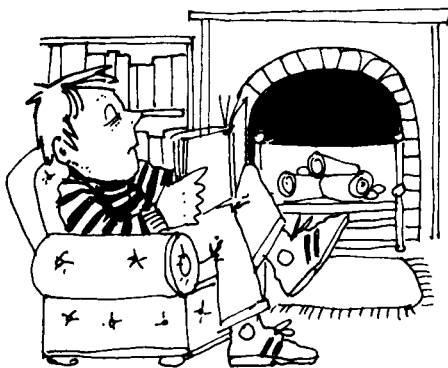

3

And Frank?



4

And Bob?

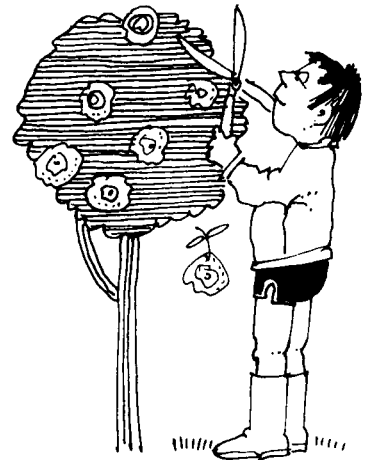

5

And Sally?



6

And Pete?

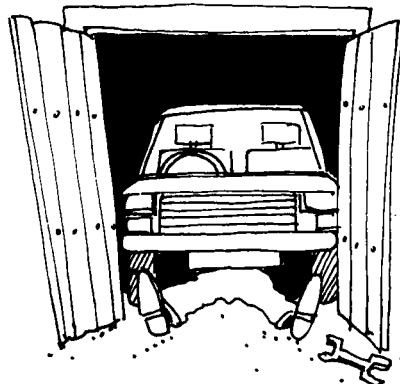

7

And Sue?



dining room    bathroom    garage    bedroom    garden  
sitting room    kitchen

# WHO?



This is Joe's photo album.  
Who is who?

For example: 1 This is my wife and son.

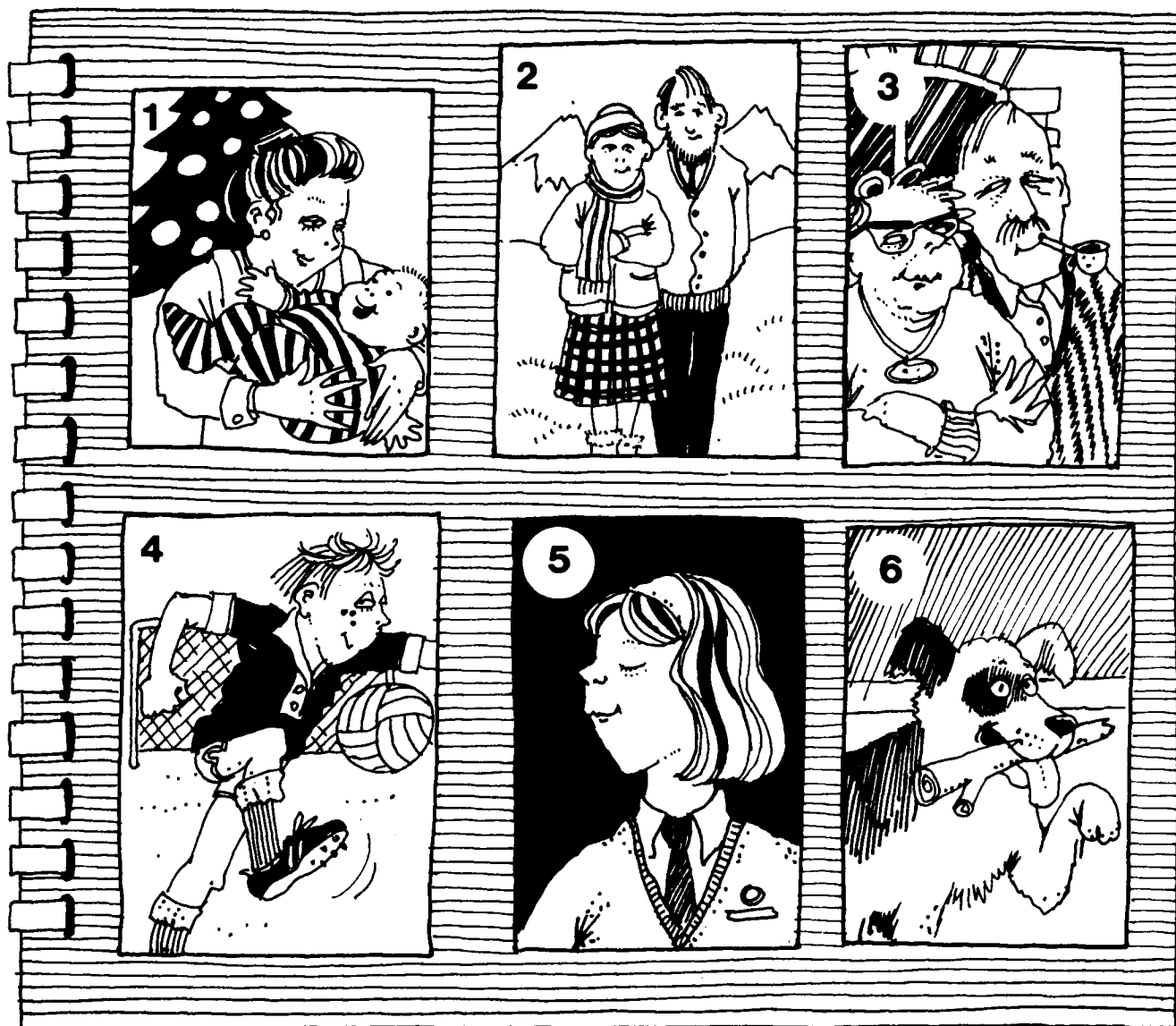

wife and son      grandfather and grandmother      sister  
father and mother      brother      dog

# CROSSWORD 1

## colours

All the answers are colours.

### Across



3 Clouds  
(sometimes)



5 Sunset  
(sometimes)



6 Sea



7 Branch  
of a tree

### Down

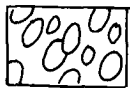

1 Snow



2 Grass



4 Sun



7 Night



8 An orange

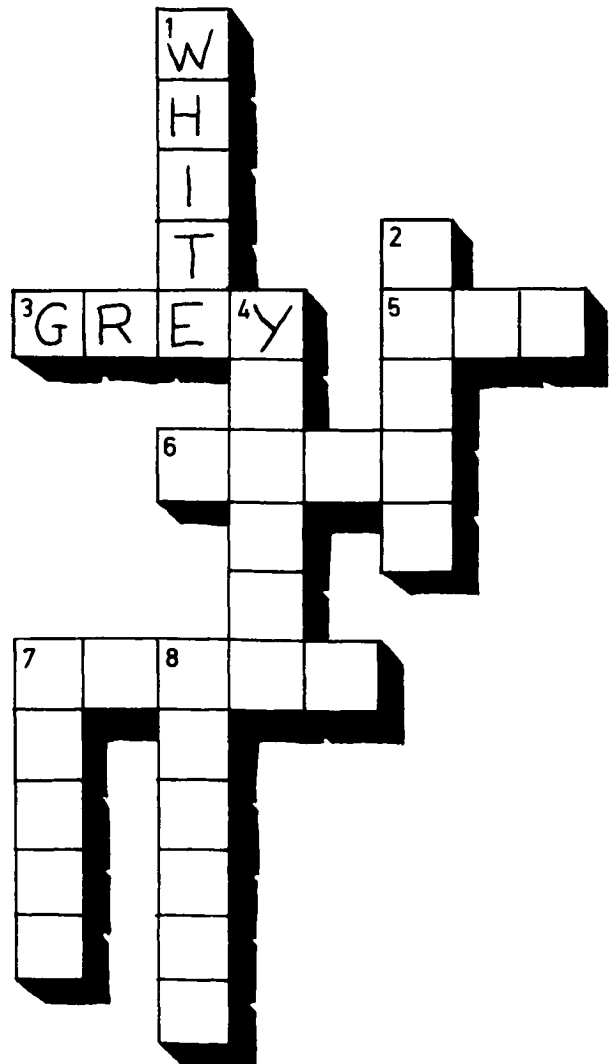

# CROSSWORD 4

All the answers are connected with **position**. Use the rabbit to help you.

Across: →

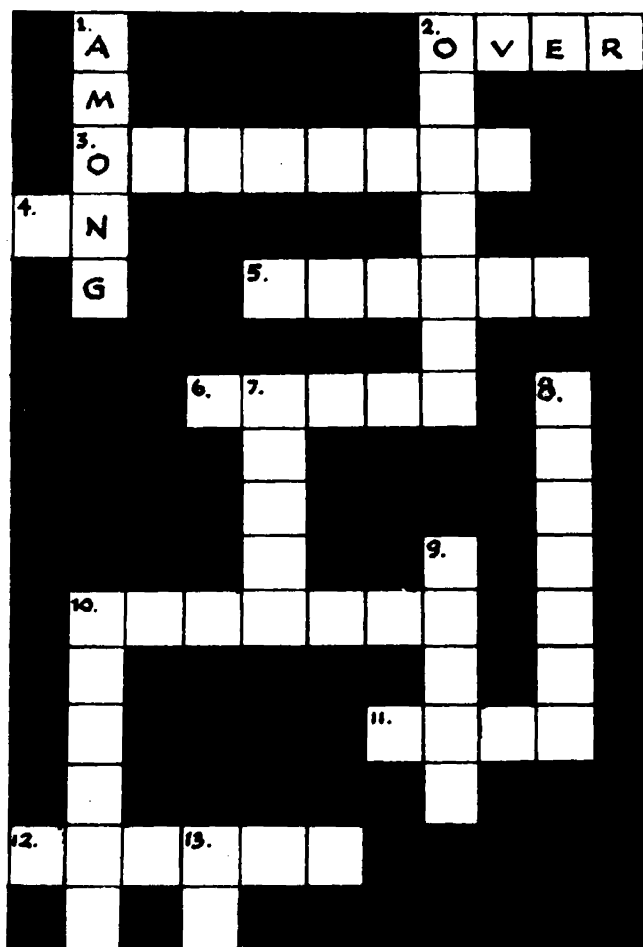
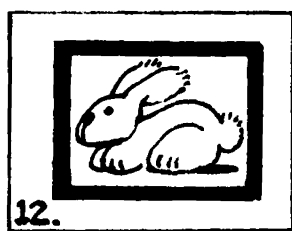
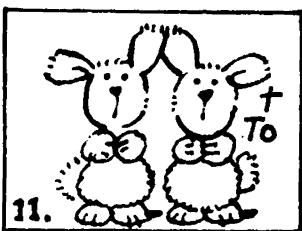
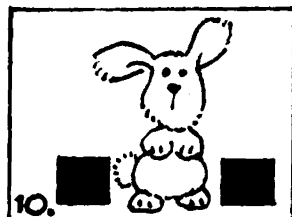
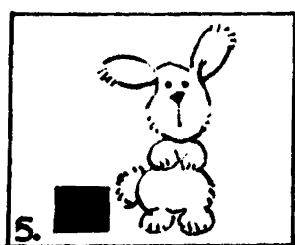
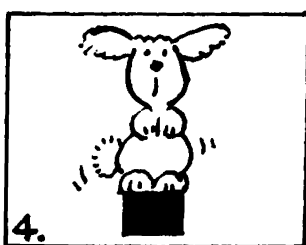
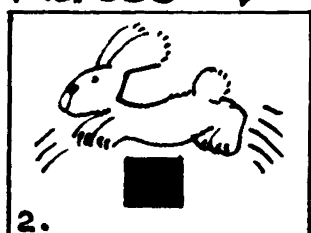

Down: ↓

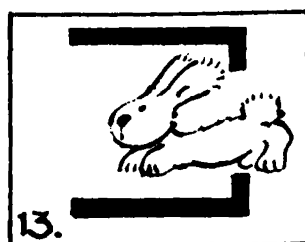
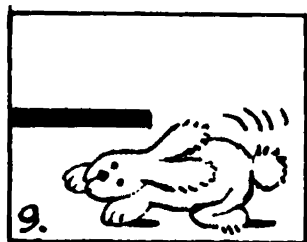
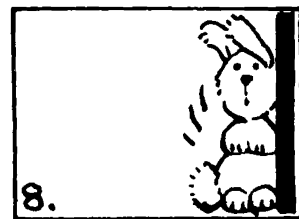
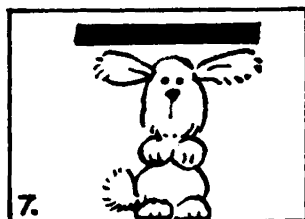
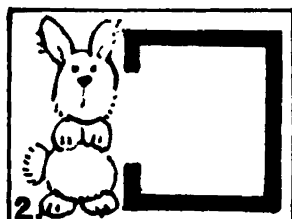
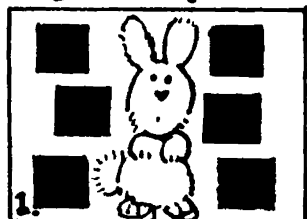

# AT THE THEATRE

Can you find your way in an English theatre?

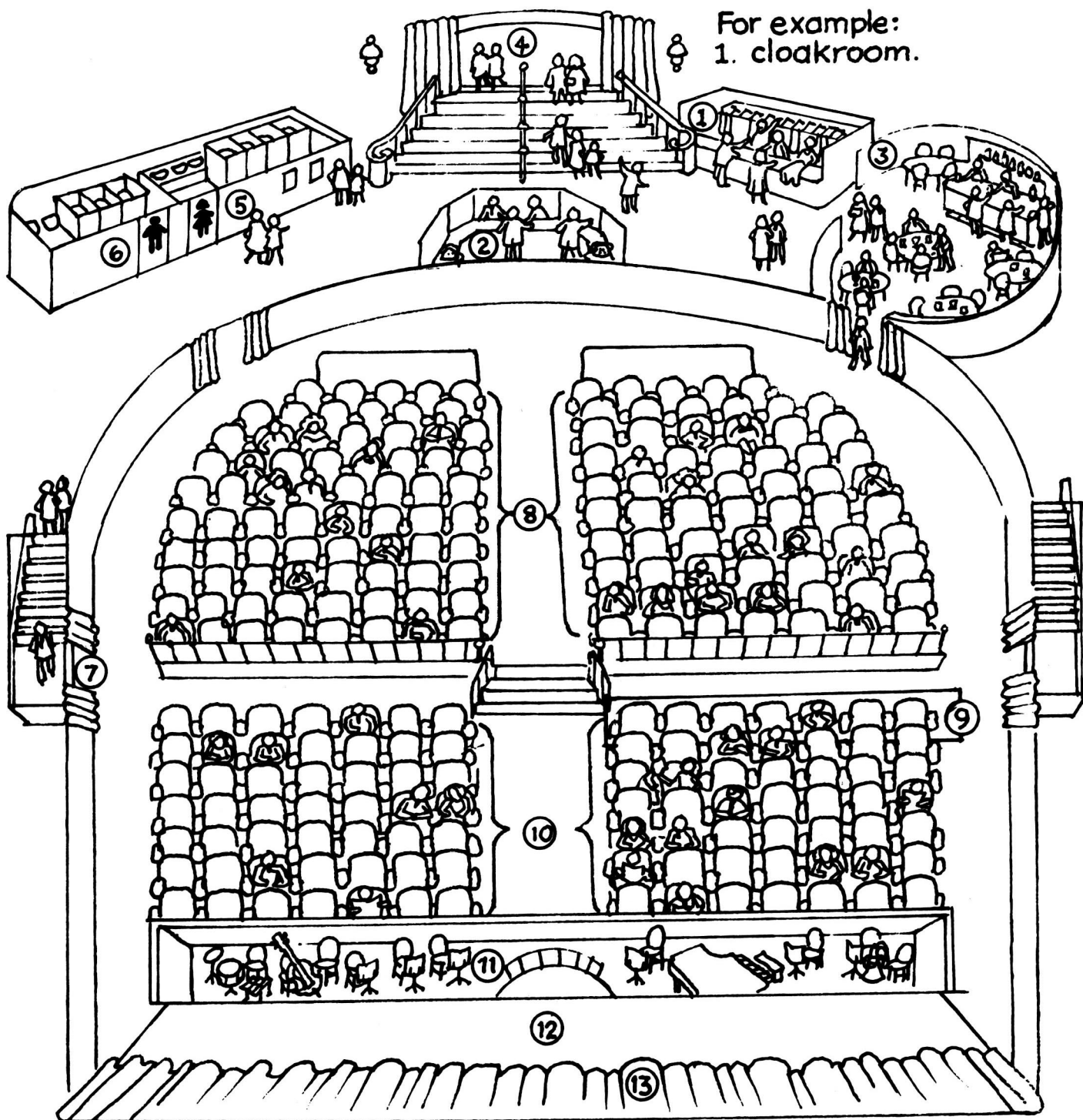

For example:  
1. cloakroom.

cloakroom row orchestra stage emergency exit bar entrance  
front seats ladies back seats gents booking office curtain











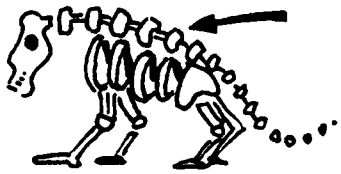



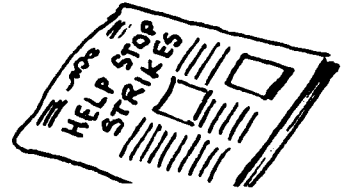
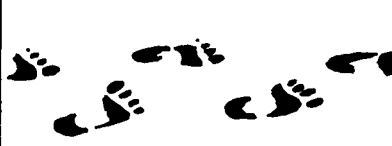

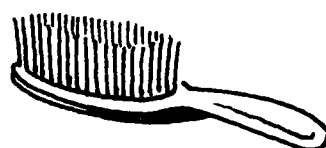
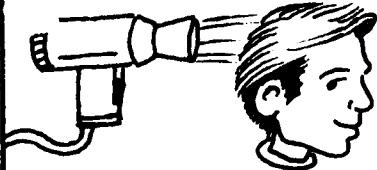

# Body Talk

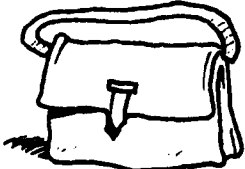
All these compounds begin with a part of the body. Can you complete them?

For example:

 <p>1. BACK bone</p>	 <p>2. BACK</p>	 <p>3. BACK</p>
 <p>4. HEAD</p>	 <p>5.</p>	 <p>6.</p>
 <p>7. FOOT</p>	 <p>8.</p>	 <p>9.</p>
 <p>10. HAIR</p>	 <p>11.</p>	 <p>12.</p>
 <p>13. HAND</p>	 <p>14.</p>	 <p>15.</p>
 <p>16. EYE</p>	 <p>17.</p>	 <p>18.</p>

# BOOKS

Here are 12 students working in the college library.  
Look carefully at the titles of the books they are reading.  
What subjects are the students studying?

For example: 1. He is studying poetry

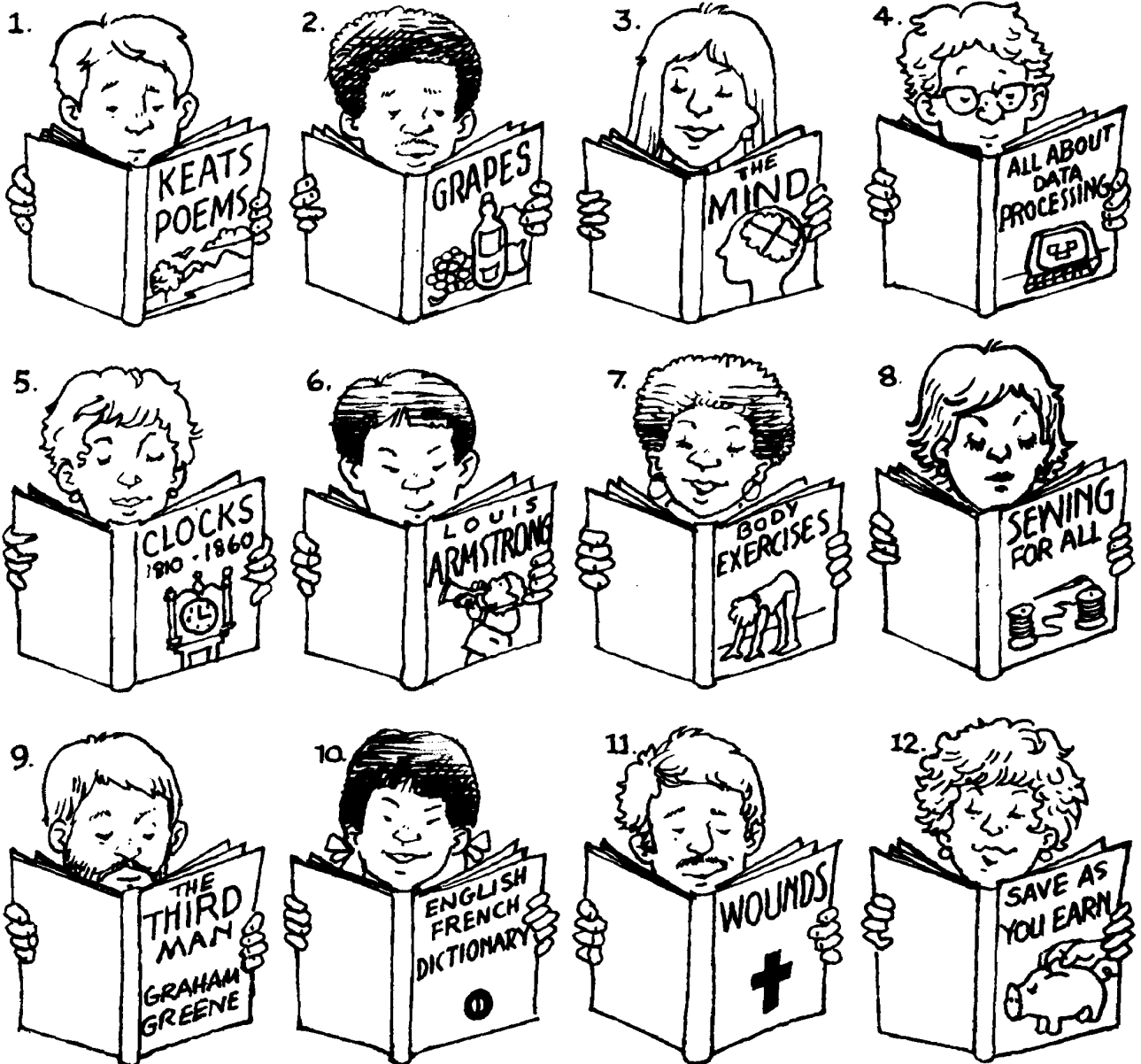

poetry    jazz appreciation    psychology    antiques    first aid  
the modern novel    keep fit    translation    dressmaking  
wine-making    banking    computer science.

# Clothes

Can you name and describe the clothes these people are wearing?  
Put the correct word from list A with the correct description from list B.

For example:  
1. A large  
handkerchief



A	B
1. handkerchief	fur
2. T-shirt	patterned
3. bra	plastic
4. sweater	dark
5. raincoat	short-sleeved
6. tie	collarless
7. belt	silk
8. shirt	plain
9. suit	child's
10. gloves	large

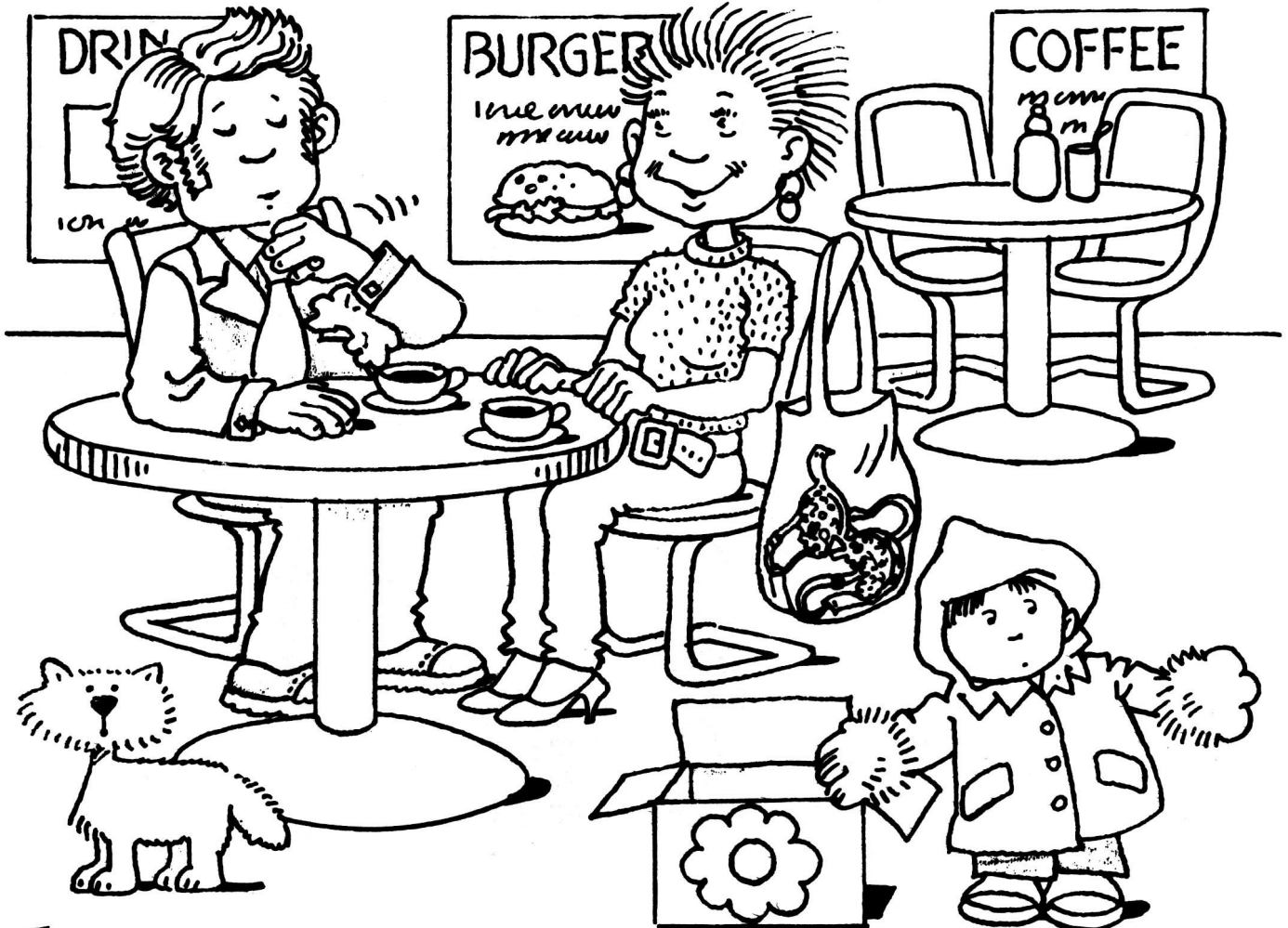



PHOTOCOPIABLE

# DOUBLES 2

Look at each picture. Then put one word from column A with another word from column B to form a compound which describes the picture. It may be one word, 2 words, or hyphenated.

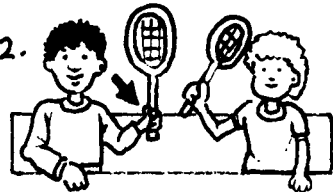
1.  PASS  
FLIGHT No 301  
AIRCRAFT TWA  
SEAT No 6A

2.  2.

3.  3.

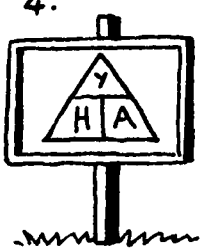
4.  4.

5.  5.

6.  6.

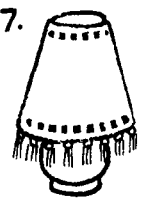
7.  7.

8.  8.

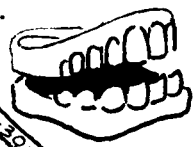
9.  9.

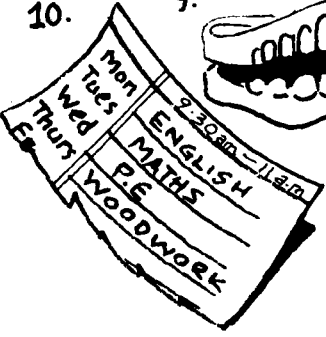
10.  10.

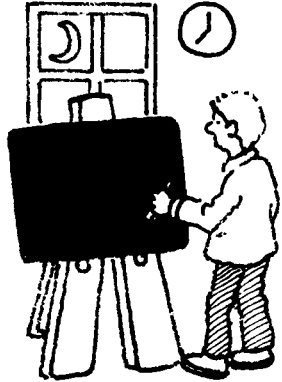
11.  11.

12.  12.

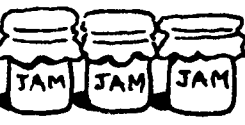
13.  13.

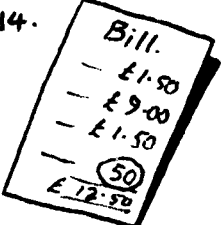
14.  14.

15.  15.

For example: 1. Boarding pass.

A	B
BOARDING	RING
THUNDER	HANDED
EVENING	SHADE
YOUTH	BULLETIN
SECONDARY	STORM
LEFT-	MADE
OPENING	HAND
FALSE	PASS
NEWS	CLASS
HOME-	HOURS
TIME	HOSTEL
SECOND-	CHARGE
SERVICE	SCHOOL
EAR	TEETH
LAMP	TABLE

# Make and do

Do you know how to use MAKE and DO correctly?

With the words below to help you, decide whether to use MAKE or DO to describe the pictures.



DO your best and try not to MAKE a mistake.

For example: 1. Make progress.



progress housework joke choice washing-up speech shopping  
trouble friends cake film homework effort business faces  
gardening



In this word square there are 15 hidden words, all connected with money matters. The words are horizontal , vertical , or diagonal .

For example:

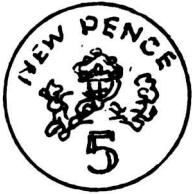

A	C	B	P	R	I	C	E	C	T
T	O	U	D	R	E	Z	Y	V	A
R	I	D	R	C	O	S	T	E	X
E	N	P	F	R	G	F	H	Q	A
C	H	E	Q	U	E	B	I	L	L
E	W	U	W	I	E	N	L	T	X
I	A	C	A	S	H	A	C	F	Y
P	G	J	S	A	L	A	R	Y	M
T	E	D	I	S	C	O	U	N	T

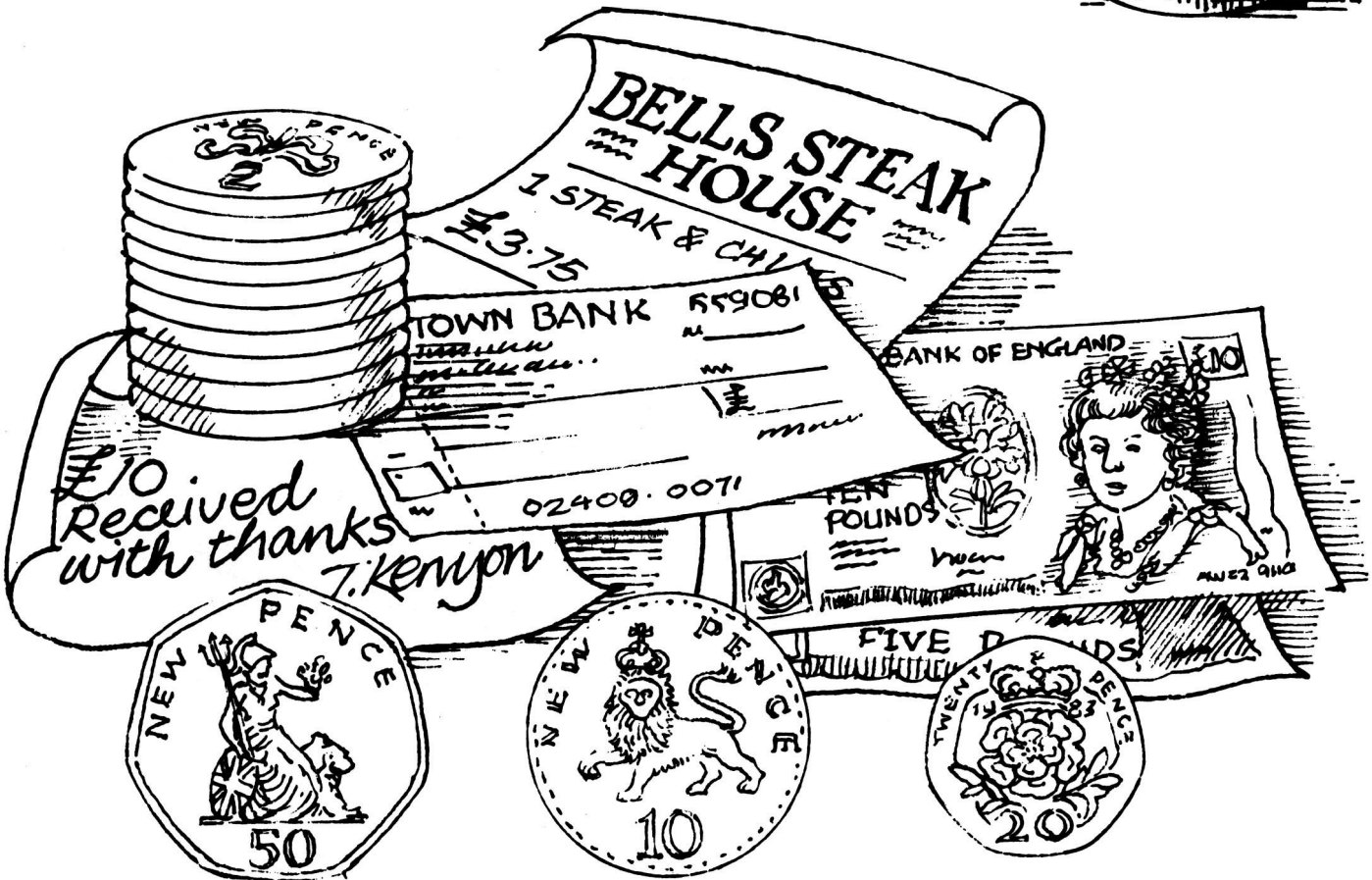
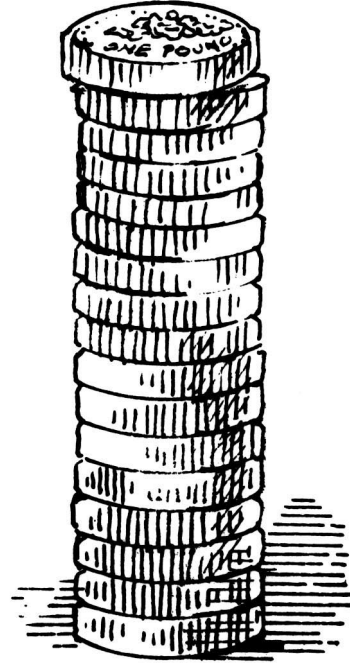

PHOTOCOPIABLE

# Odd One OUT 1

Look at these groups of words.  
Which word does not fit?

For example:

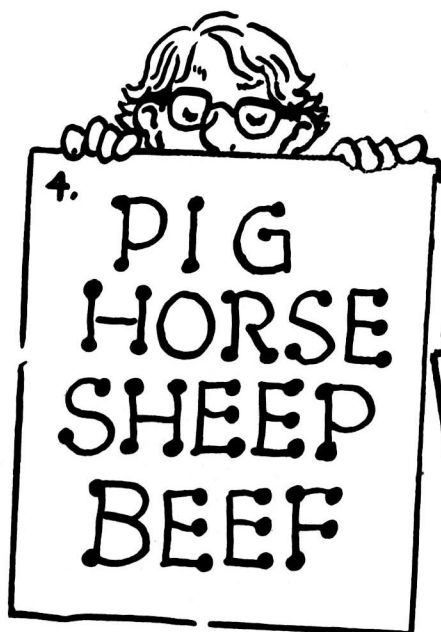

# Odd One OUT 3

Here are 8 groups of adjectives.  
Which word is the odd one out in each group?



For example:

1. speedy <u>slow</u> swift rapid	2. huge enormous immense tiny
3. pretty graceful handsome ugly	4. reduced costly unreasonable dear
5. glad sad merry cheerful	6. rusty spotless stained dusty
7. scared frightened cowardly bold	8. sickly healthy sound fit



# Odd One OUT 4

Here are 8 groups of words, all connected with the countryside.

Which word is the odd one out in each group?

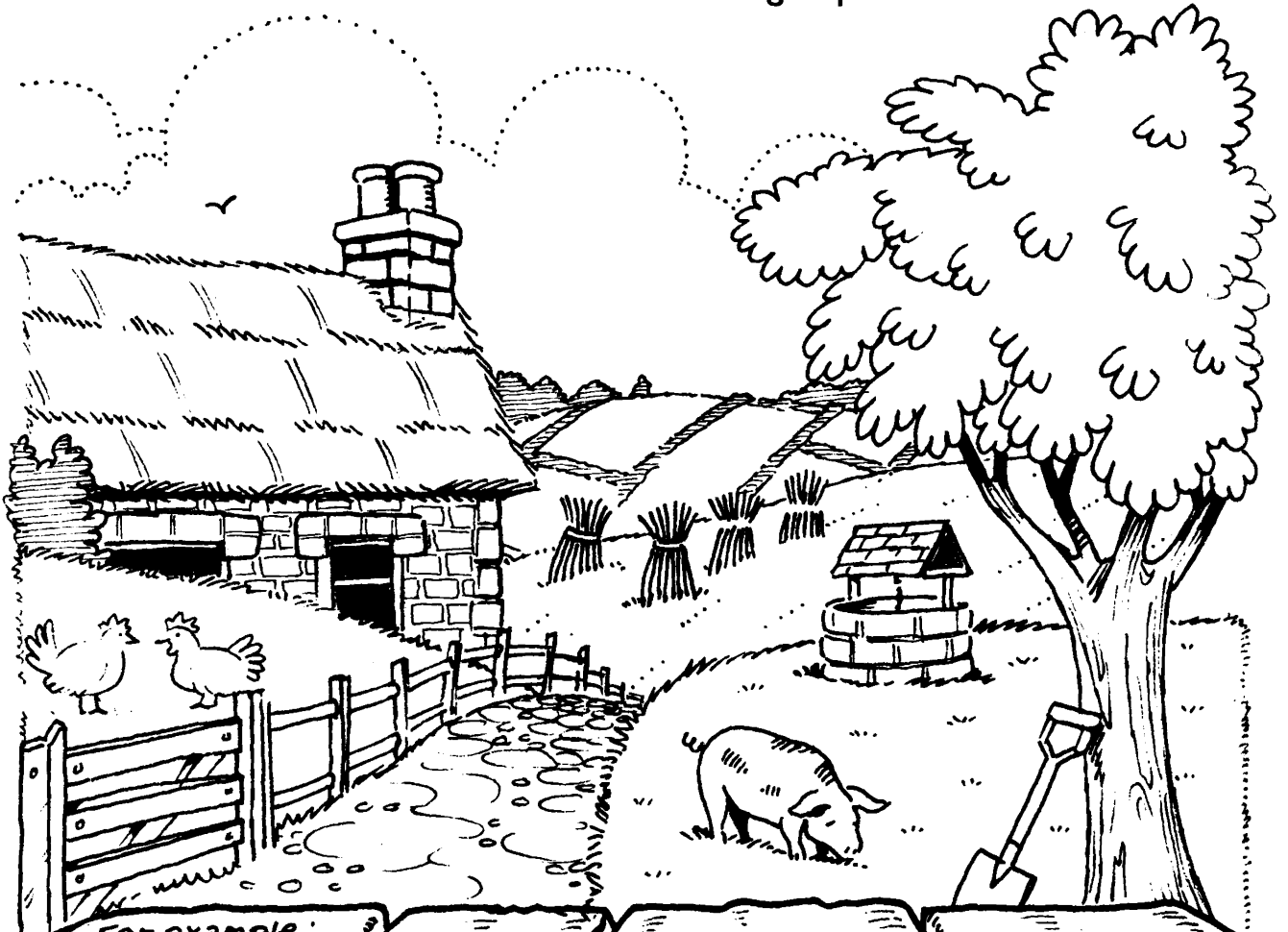

For example:

1. bridge fence  
hedge wall

2. plough spade  
meadow rake

3. shed gate  
hut farmhouse

4. crops hens  
leaves seeds

5. rabbit pig  
goat bee

6. cliff pool  
pond well

7. road way  
path field

8. corn hay  
bush wheat

# oo and ee

Look at this picture.

Can you find 11 words with double o 'oo' and 8 with double e 'EE'?



For example: boots, sleeves

PHOTOCOPIABLE

# The Family Tree

Look at Steve's family tree and the list of his relations.  
Write the names of Steve's relations.

For example: 1. Sidney is Steve's grandfather.

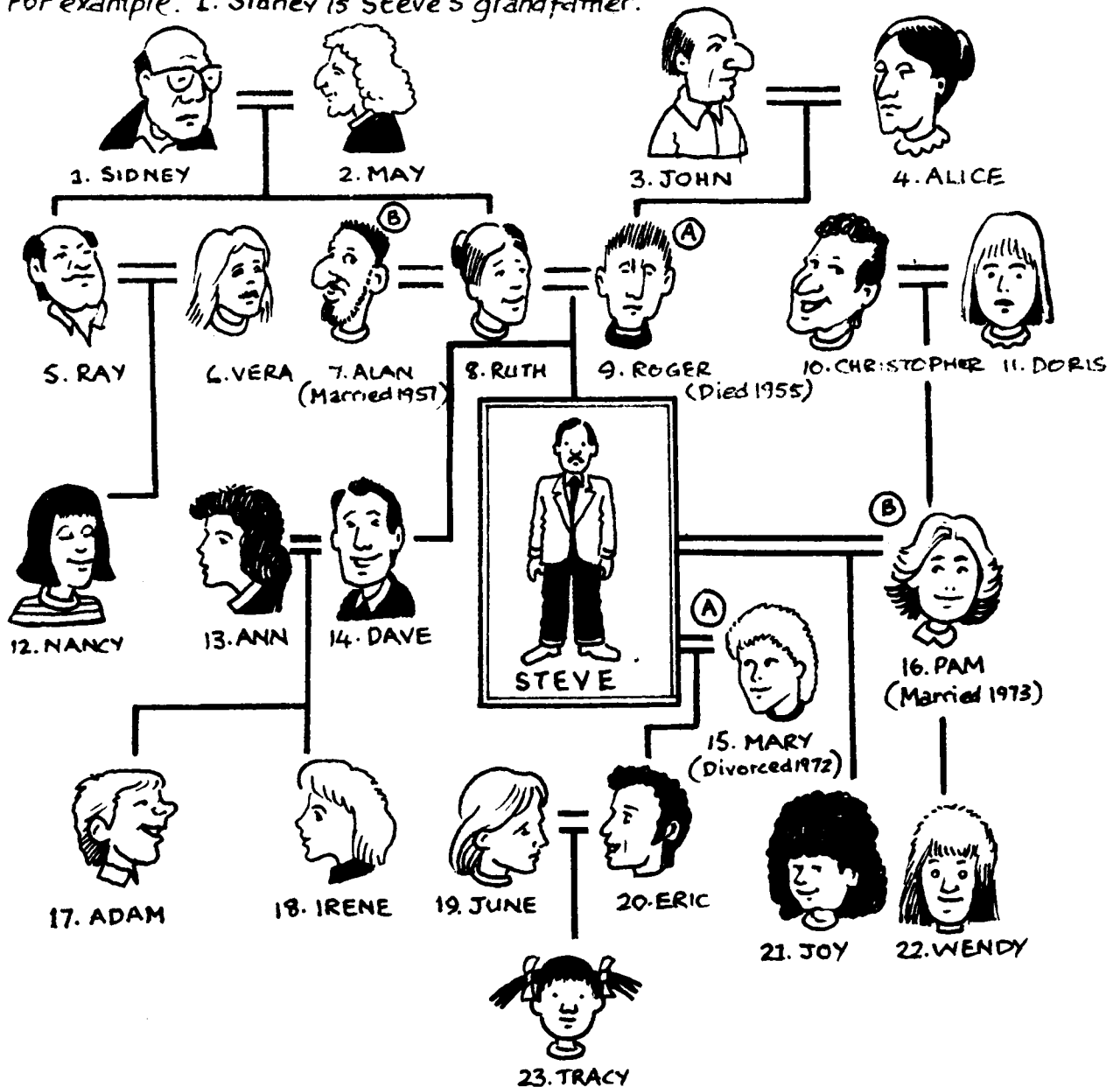

- aunt   first wife   mother-in-law   grandmother   daughter
- daughter-in-law   mother   uncle   grandfather   nephew   father-in-law
- cousin   sister-in-law   step-father   second wife   step-daughter   niece
- brother   granddaughter   son   father

# The word Snail

There are 30 words in this word snail. They are all connected up and describe what you might see in the English countryside. Can you find them?

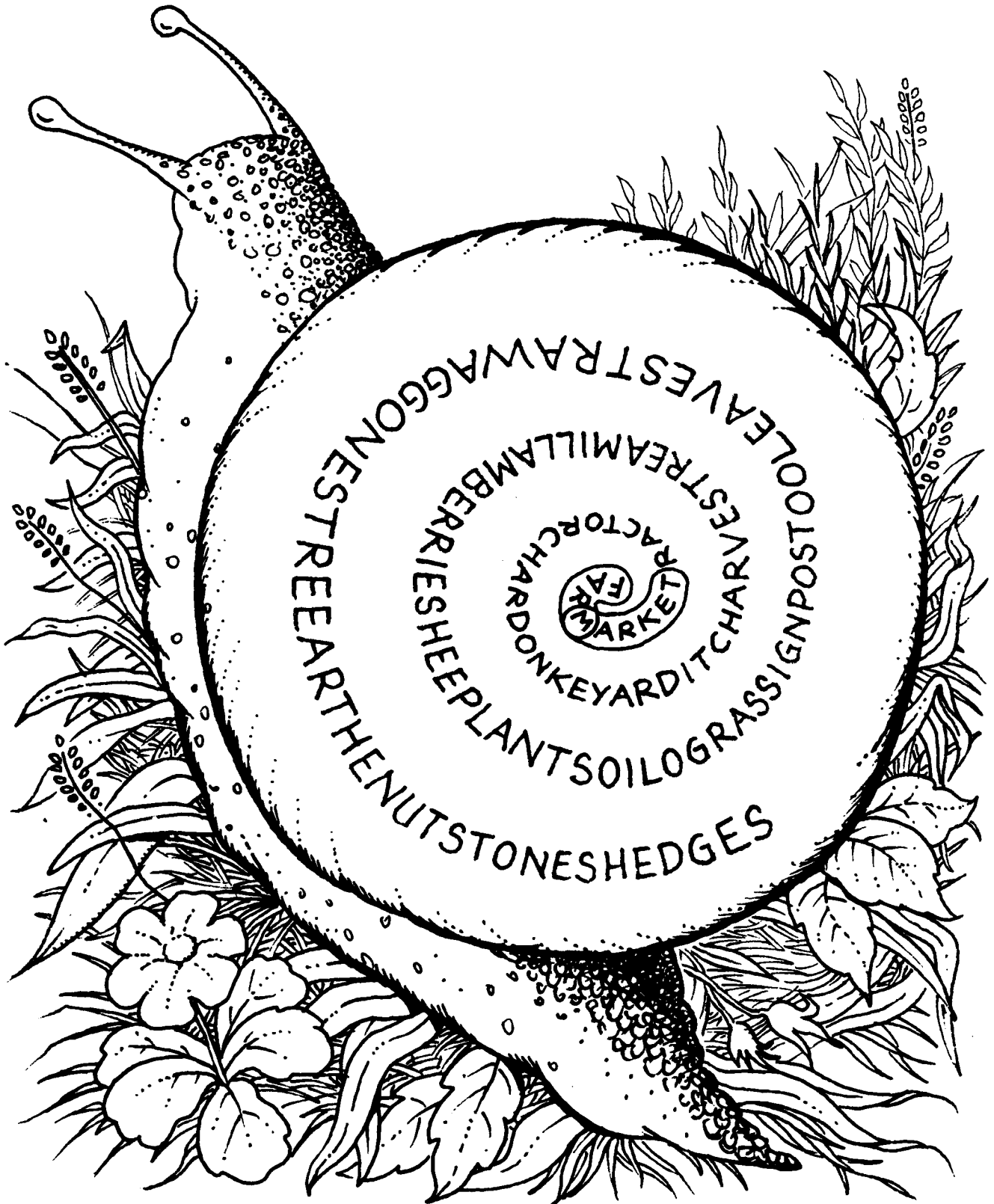

# Time Off

These 6 people have different plans for their time off. What things do they need?

For example:

1. parasol: ...

2. I'M GOING TO MAKE SOME CURTAINS.

3. I'M GOING FISHING.

4.

5. I'M GOING TO REDECORATE THE BATHROOM.

6. I'M GOING TO LOOK AFTER MY BABY NIECE FOR THE WEEKEND.

I'M GOING TO THE BEACH.

I'M GOING WALKING IN THE MOUNTAINS

parasol swimsuit rod needle nappies line plaster  
 climbing boots cot deck-chair compass hook thread stick  
 material push-chair net wallpaper rope suntan lotion  
 tape measure tiles paste talcum powder

# Words beginning with CAR-

Here are 12 words which begin with CAR-. The pictures and the number of letters will help you to complete the words.

For example:

1. CARAVAN

2. CAR

3. CARROT

1. 

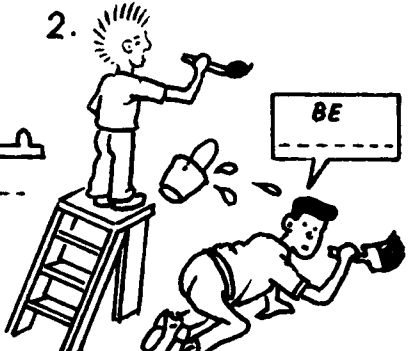
2. 

3. 

4. CAR

5. CAR

6. CAR

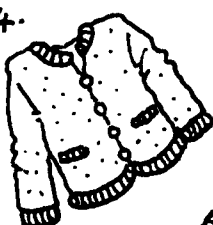
4. 

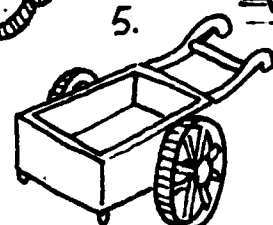
5. 

6. 

7. CAR

8. CAR

9. CAR

8. 

7. 

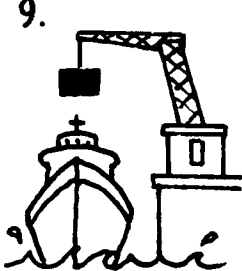
9. 

10. CAR

11. CAR

12. CAR

10. 

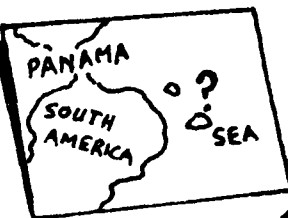
11. 

12. 

# Words easily confused

These pairs of words are often confused.

Look at the picture and choose the correct word.

For example:

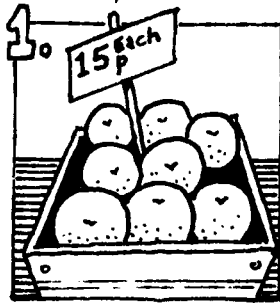

prize/price

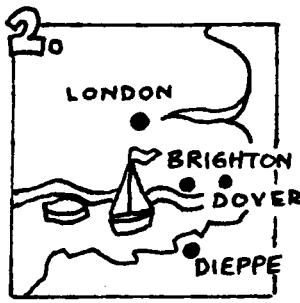

channel/canal

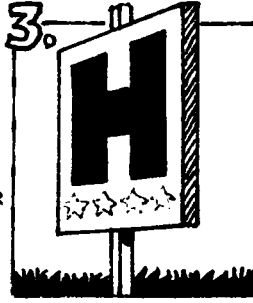

hotel/hostel

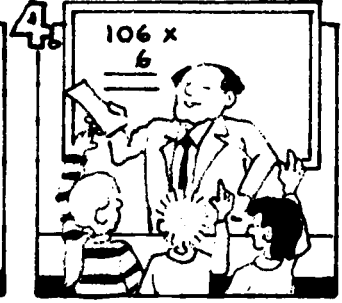

professor/teacher



audience/spectators



doctor/surgeon

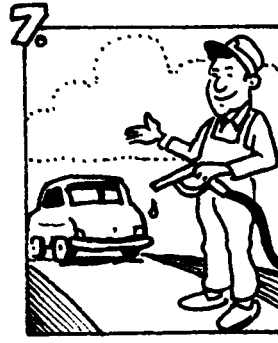

assistant/attendant

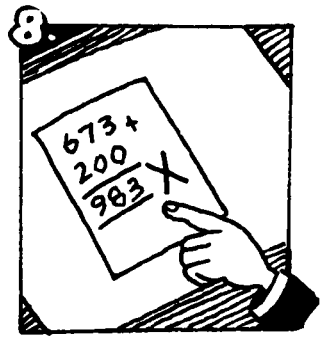

fault/mistake



bank/shore

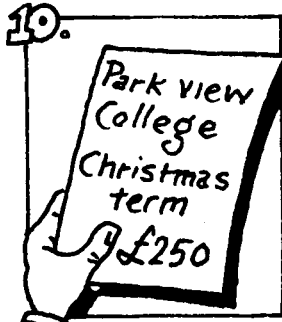

fees/salary

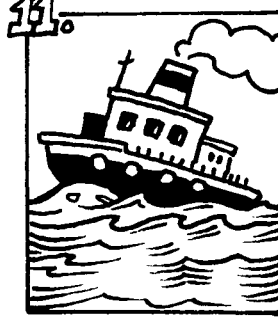

journey/voyage



bath/bathe



newspaper/magazine



hedge/fence



duty/tax



housework/homework

# as...as...

Do you know these expressions?

Look at the pictures and then choose the correct noun and adjective to describe each one.

as **dry** **pretty** **brave** **black** **hard**  
**light** **quiet** **cold** **hot** **sick**

as a feather a rock ice a mouse a dog  
a picture a lion coal dust hell

For example : 1. as dry as dust.

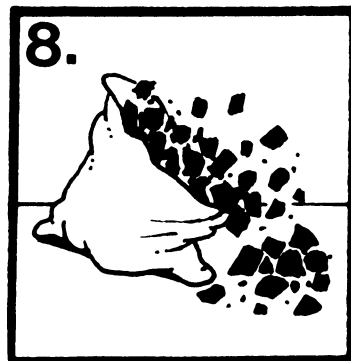
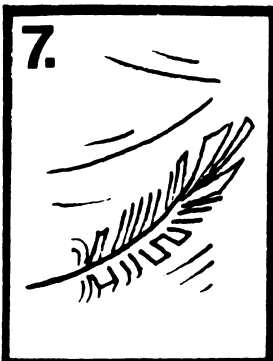
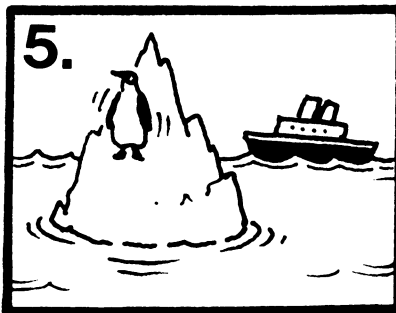
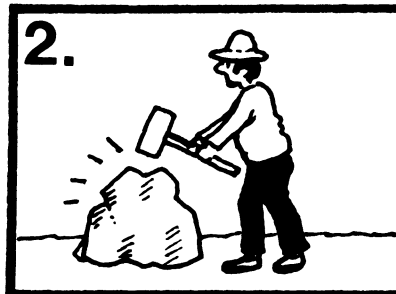
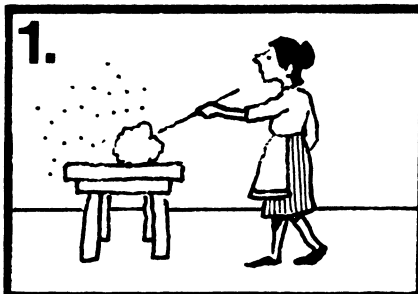





Sometimes in English and American English there are different words for the same thing. Look at the pictures and find the 15 pairs of English and American words.

1. For example: 1. Trousers (G.B.)  
2. Pants (U.S.)

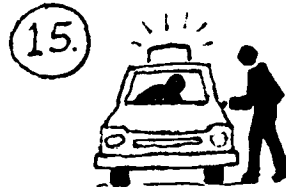
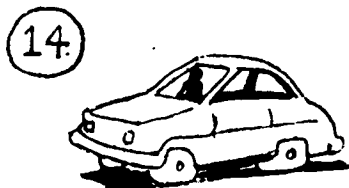
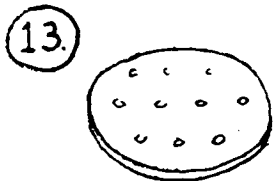
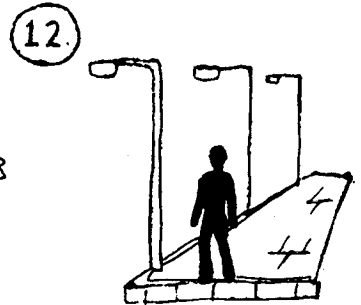
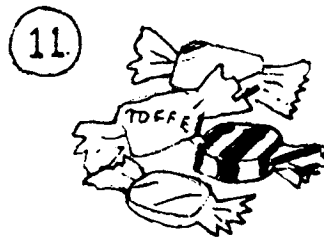
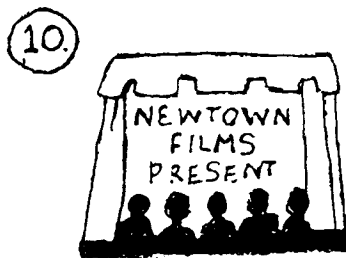
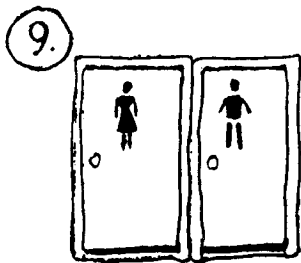
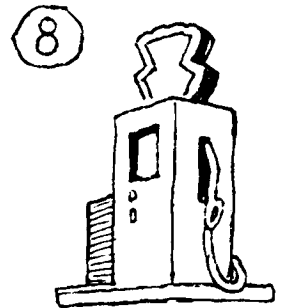
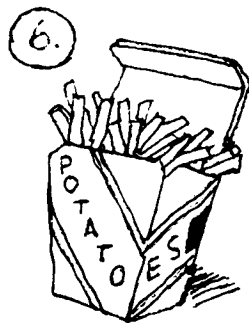
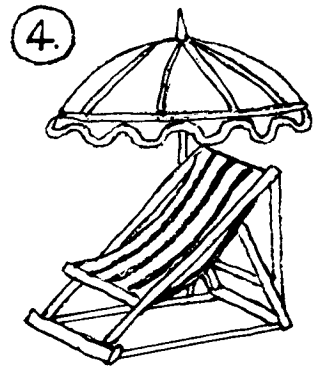
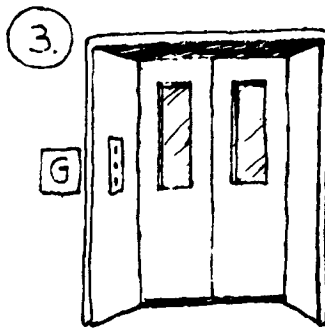
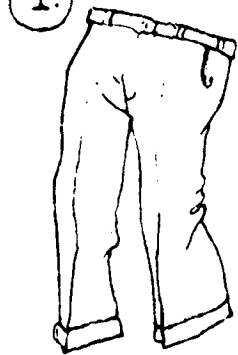

trousers   movies   chips   autumn   pants   gas   sweets   vacation  
 sidewalk   lift   taxi   fall   cab   tube   elevator   return   pavement  
 cinema   lavatory   car   restroom   roundtrip   French fries   candy  
 automobile   petrol   subway   cookie   holiday   biscuit

# CRIME AND PUNISHMENT

All the answers to this crossword are connected with criminal and legal matters.

For example:

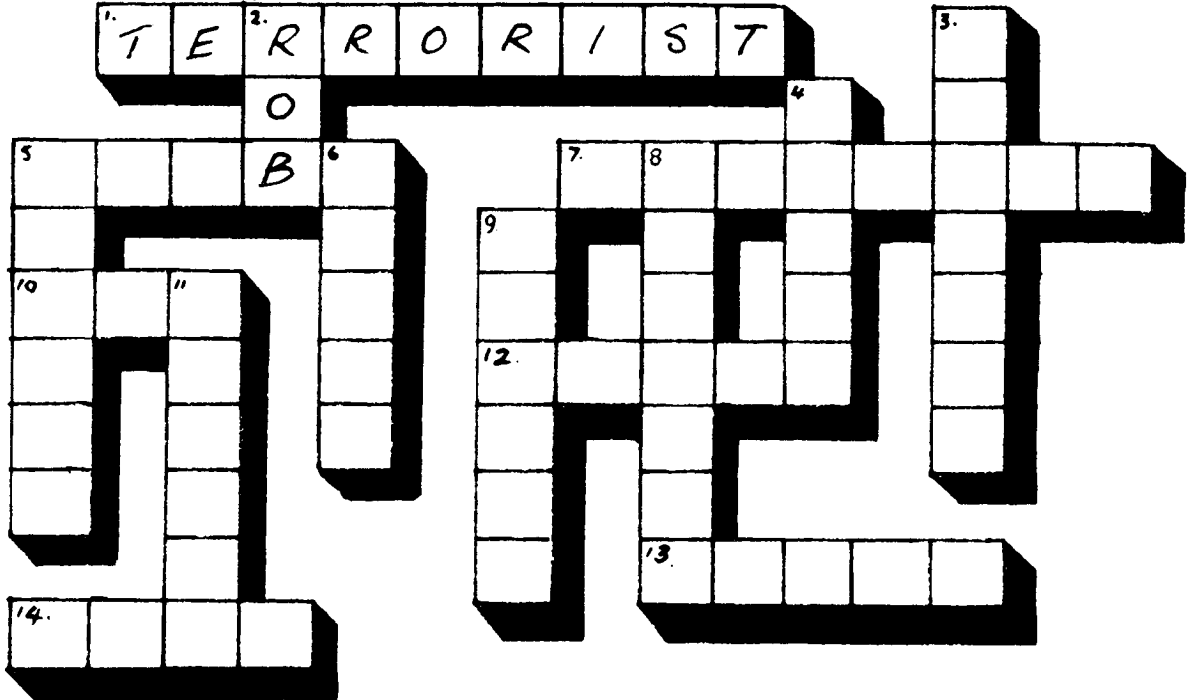

## ACROSS →



10. STEALING IS ILLEGAL. IT'S AGAINST THE

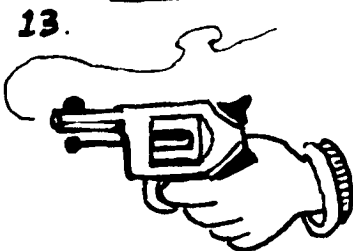
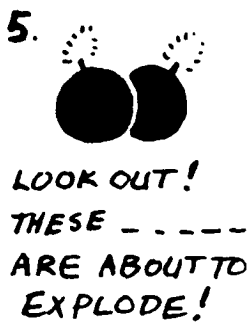

14. WHEN YOU PARK YOUR CAR IN THE WRONG PLACE, YOU HAVE TO PAY A

## DOWN ↓



5. AMMUNITION FOR A PISTOL.



6. WHAT THIEVES DO.

THIS LITTLE GIRL HAS BEEN TAKEN AS A

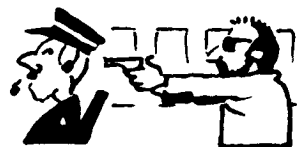

HE IS GOING TO THE PLANE.

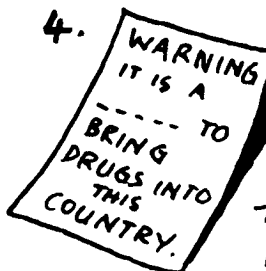

11. THIS AXE WAS THE MURDER

# CROSS-IT-OUT

On the artist's palette are the names of things which are usually connected with particular colours (although a few can sometimes be seen in other colours too).

Read the 11 clues and cross out the correct number of names each time. Finally you will be left with 1 thing. What is it? And what colour is it?

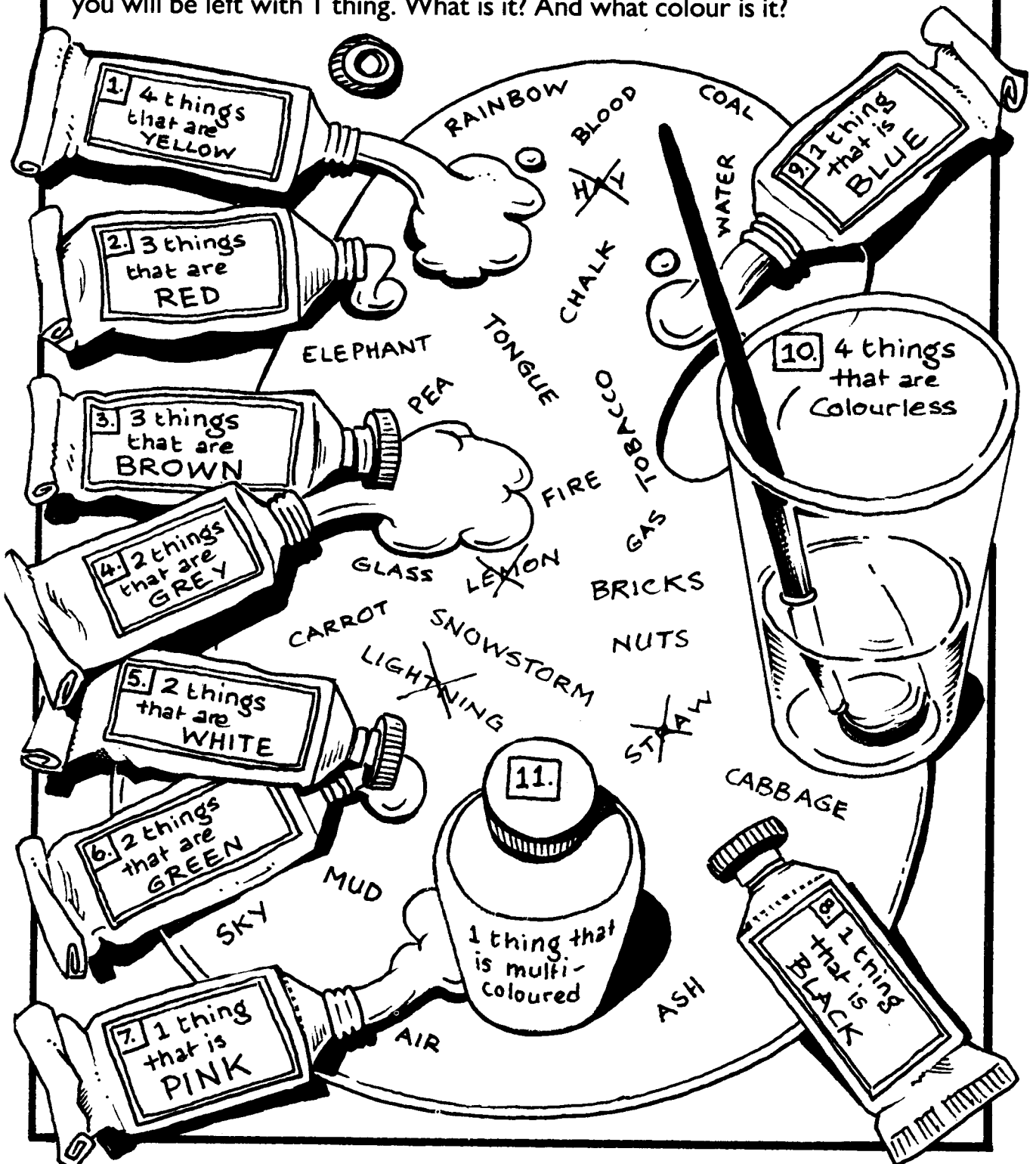

# Food for Thought

A busy restaurant serves the following: MEAT, FISH, VEGETABLE CURRY, SAUCES, BREAD, FRUIT, WINE and COFFEE.

If you heard these complaints from diners, what would they be talking about?

For example:

1 BREAD

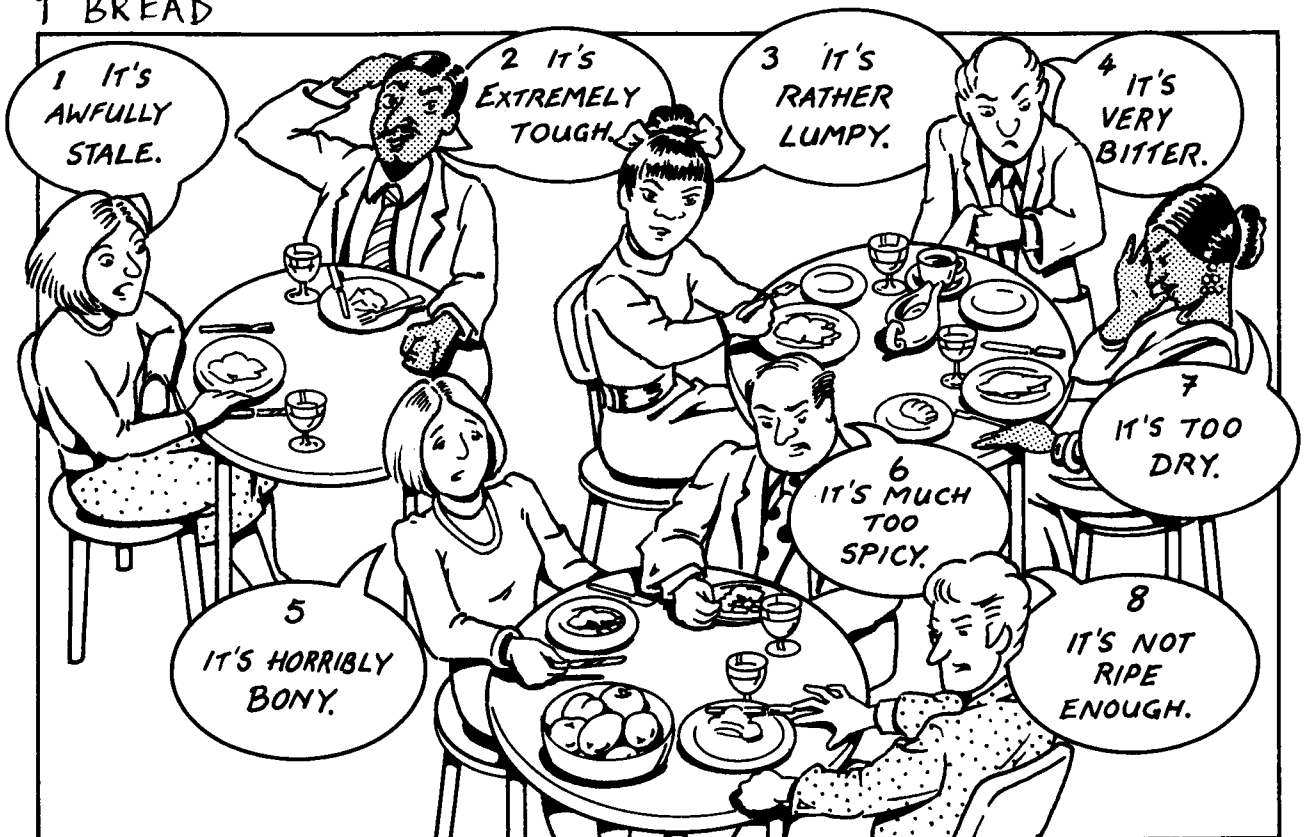

Now choose from the adjectives below to describe the following in different ways: (some of the adjectives can be used more than once)

For example:

a cup of tea

a type of cheese

a glass of lemonade

- 1 strong
- 2 milky
- 3 \_\_\_\_\_
- 4 \_\_\_\_\_
- 5 \_\_\_\_\_
- 6 \_\_\_\_\_

- 1 \_\_\_\_\_
- 2 \_\_\_\_\_
- 3 \_\_\_\_\_
- 4 \_\_\_\_\_
- 5 \_\_\_\_\_
- 6 \_\_\_\_\_

- 1 \_\_\_\_\_
- 2 \_\_\_\_\_
- 3 \_\_\_\_\_
- 4 \_\_\_\_\_
- 5 \_\_\_\_\_
- 6 \_\_\_\_\_

**strong** ripe mild iced sweet tasty tough weak  
sparkling crumbly refreshing hard dry still fizzy **milky**

# Four of a Kind

Follow the zigzag down and find the noun which can go with all 4 words.

For example: 1 box

(4 kinds of box : signal box, window box, fuse box and witness box)

signal window fuse witness	green light council public	sewing fruit slot vending	dining racing sports cable	surf diving notice black
1 box	2	3	4	5
wall exam toilet wrapping	Christmas credit identity membership	reading sun opera dark	class spare changing store	sleeping paper carrier shoulder
6	7	8	9	10
over under milk rain	flower tea chimney jack	clothes dotted yellow assembly	race rocking sea cart	cheque exercise phone phrase
11	12	13	14	15
search political dinner birthday	maiden family brand pet	card kitchen billiard bedside	cigarette book dead loose	correspondence race main golf
16	17	18	19	20

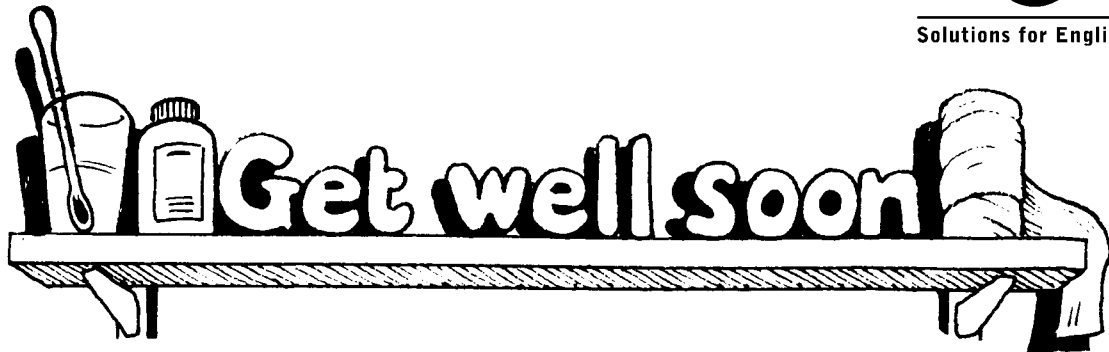

All the answers to this crossword are connected with health and illness.

For example:

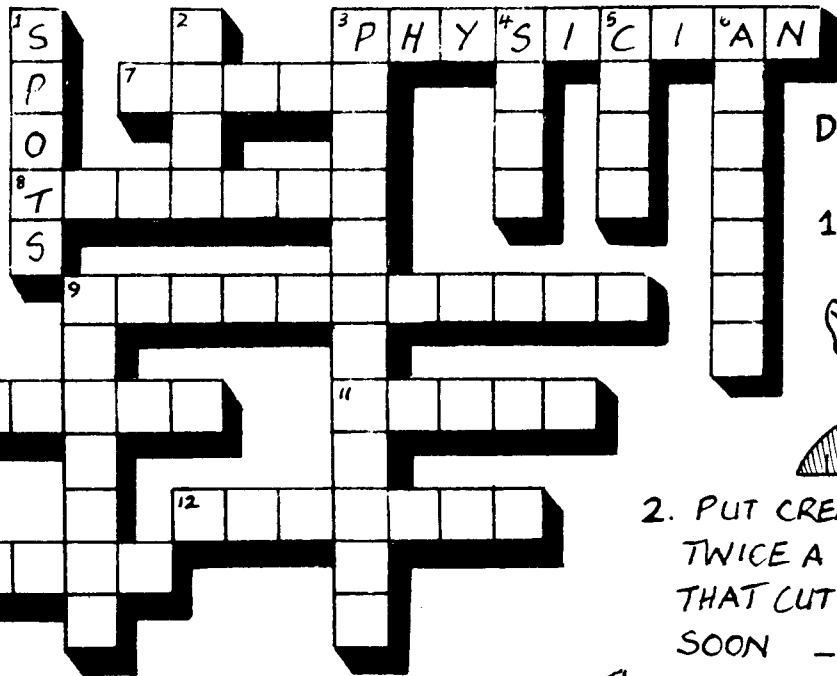

ACROSS →

DOWN ↓



7. HIS TEMPERATURE IS VERY HIGH. HE'S GOT A -----

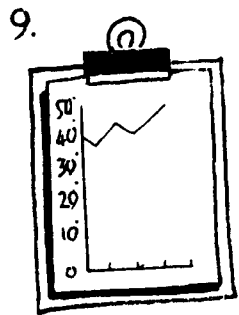

12. A SICK PERSON IN A HOSPITAL.

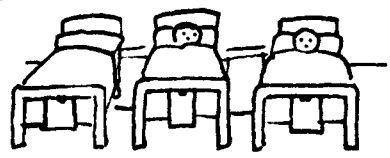

13. THIS IS A HOSPITAL -----



Mrs Brown  
20 Tablets of  
Anti-Biotics -  
*blue*

3. THE DOCTOR HAS GIVEN MRS BROWN A -----

4. MY THROAT IS VERY -----



5. THE ----- FOR YOUR ILLNESS IS SIMPLY REST



9. A ROOM IN A HOSPITAL WHERE OPERATIONS TAKE PLACE.

# GLIDOGRAM 2

Complete the Glidogram by looking at the clues. The first 12 words all contain the letters **EST** and the second 12 the letters **AL** (3 at the beginning of the word, 4 in the middle of the word and 5 at the end of the word each time).

1 set up, found

2 guess, reckon

3 a large area of land

4

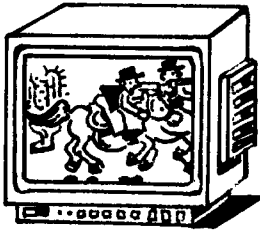

5

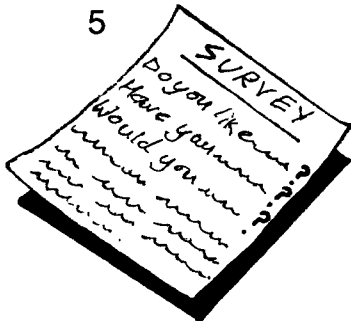

6

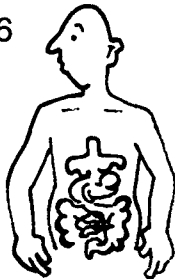

7 examination

8 an objection

9 the gathering of ripe crops

10 a visitor

11 money charged on a loan

**ABC...** 24

For example:

1	ESTABLISH
2	
3	
4	
5	
6	
7	
8	
9	
10	
11	
12	
13	/ AL
14	
15	
16	
17	
18	
19	
20	
21	
22	
23	
24	

23



22

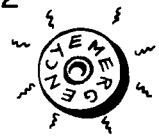

21 the same status

20



teeth

19 an ill or disabled person

18 someone whose business involves buying and selling

17



16 ultimate

15 irregular

14 an organized event (often music or drama)

13 a model and example of perfection

12



# HEADLINES

Which of the words in each headline can be replaced by 1 of the words below.  
Mark them both.

For example:

1. a fail  
b continue  
c succeed  
d delayed



2. a stops  
b votes  
c encourages  
d prevents

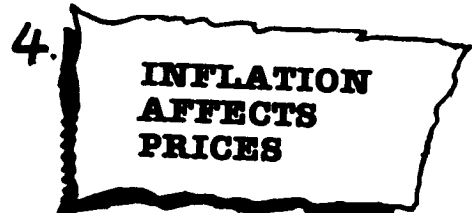

3. a finished  
b increased  
c refused  
d begun



4. a changes  
b improves  
c influences  
d decreases

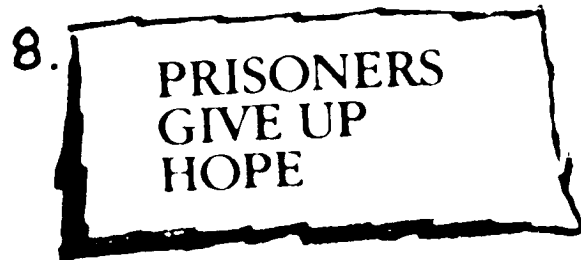
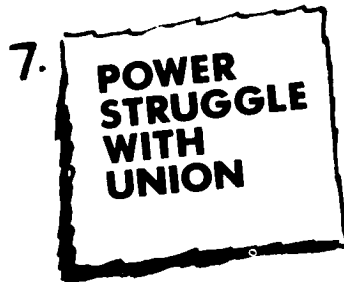

5. a disaster  
b destruction  
c escape  
d answer



6. a chooses  
b sacks  
c pays  
d criticises

7. a agreement  
b fight  
c discussion  
d inquiry

8. a want  
b expect  
c express  
d lose

9. a players  
b supporters  
c managers  
d families

10. a risk  
b win  
c opportunity  
d prize



# Leisure & Pleasure

Take 1 letter from each word in the lists below to find 12 popular leisure activities and interests that people enjoy in their spare time. The words in the lists are all connected to each activity.

The same 12 words are also hidden in the word square below. Use this to give you ideas and to check your answers.

For example:

- 1 socks needles cardigan thread stitch plain pattern gloves knitting
- 2 valuable china furniture rarity quality beauty objects shops \_\_\_\_\_
- 3 shape decoration earthenware craft wheel fire clay \_\_\_\_\_
- 4 pointed aim score throw pubs \_\_\_\_\_
- 5 championship check mate bishop castle \_\_\_\_\_
- 6 company tame cats stroke \_\_\_\_\_
- 7 director critics curtain amateur applause \_\_\_\_\_
- 8 make objects display miniature collect scale \_\_\_\_\_
- 9 clubs cards diamonds spades game hearts \_\_\_\_\_
- 10 fabrics magazines style clothing designers models changes \_\_\_\_\_
- 11 recipe oven boil cake stove apron electricity \_\_\_\_\_
- 12 stamina strength rhythm oxygen body fit exercise gym \_\_\_\_\_

The words are horizontal , vertical , or diagonal 

For example:



a	e	r	o	b	i	c	s	l	u	i
w	l	a	k	m	o	d	e	l	s	g
u	d	o	n	g	h	c	h	e	s	s
f	e	h	i	d	o	f	u	t	c	y
a	r	d	t	a	m	q	a	d	r	b
s	t	r	t	r	i	x	t	e	l	r
h	s	a	i	t	u	s	k	y	p	i
i	b	m	n	s	n	o	l	j	e	d
o	r	a	g	e	o	z	d	s	t	g
n	t	q	h	c	s	a	u	p	s	e
y	d	e	t	p	o	t	t	e	r	y



# LINKS

Find the link between the first 2 words and then find a similar link to complete the sentence.

*For example:*

1. *Pound is to pence as dollar is to:*

- a note                      b coin                      c gram                      **d cent**

2. *Elephant is to hide as bird is to:*

- a feather                      b wing                      c beak                      d fur

3. *Petrol is to tank as wine is to:*

- a label                      b grape                      c cork                      d barrel

4. *Man is to foot as dog is to:*

- a collar                      b nail                      c paw                      d tail

5. *Heaven is to holy as hell is to:*

- a devil                      b evil                      c murder                      d violence

6. *Directory is to phone number as dictionary is to:*

- a book                      b translation                      c word                      d index

7. *Video is to video-cassette as computer is to:*

- a tape                      b program                      c screen                      d calculation

8. *Saucer is to crockery as paper is to:*

- a stationery                      b envelope                      c office                      d file

9. *Lung is to breathe as throat is to:*

- a taste                      b tongue                      c swallow                      d cough

10. *Bread is to baker as clothes are to:*

- a wardrobe                      b uniform                      c dry cleaner                      d tailor

# The Living World

Take 1 letter from each word to find 13 animals, birds and reptiles.

The words in the clues will help.

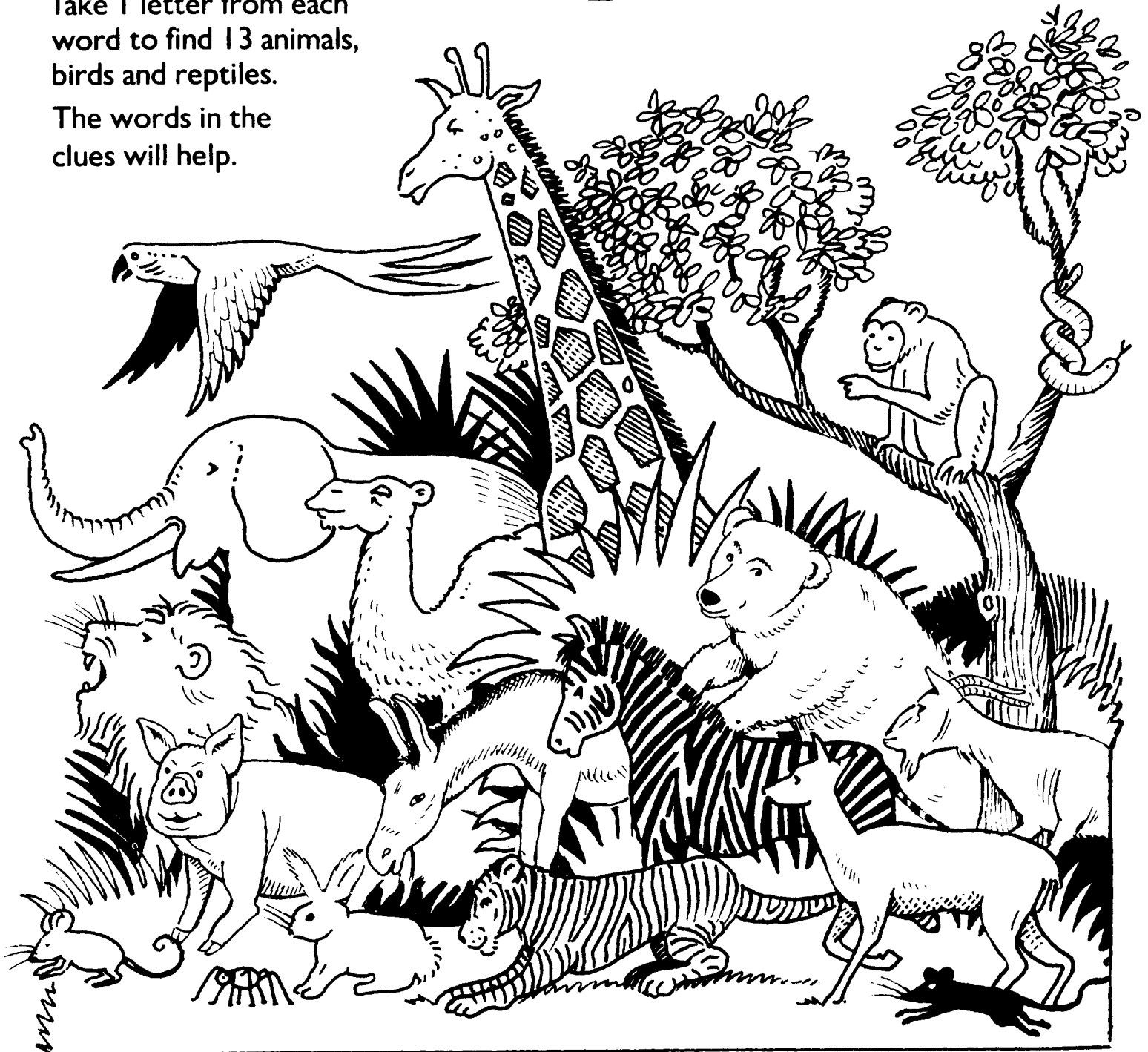

For example: 1. R-A-T = rat.

- |   |   |
|---|---|
| 1. brown tail bite                                | 7. ears grass babies burrow field fast      |
| 2. speak gay tropical feathers multi-coloured pet | 8. carry aggressive jump desert long-necked |
| 3. golden king roar jungle                        | 9. poison long scales quick tongue          |
| 4. black forest large fur                         | 10. pink dirty greedy                       |
| 5. hunt striped growl fierce courageous           | 11. small nervous quiet cheese hole         |
| 6. timid speedy gentle herd                       | 12. angora horns hair mountains             |
|   | 13. loud cross stubborn back hooves grey    |

# PAIRS

Here are 34 words that form 17 common phrases linked by AND. Find the pairs of words and put them in the correct order.

For example: *Ladies and gentlemen*

(not gentlemen and ladies)

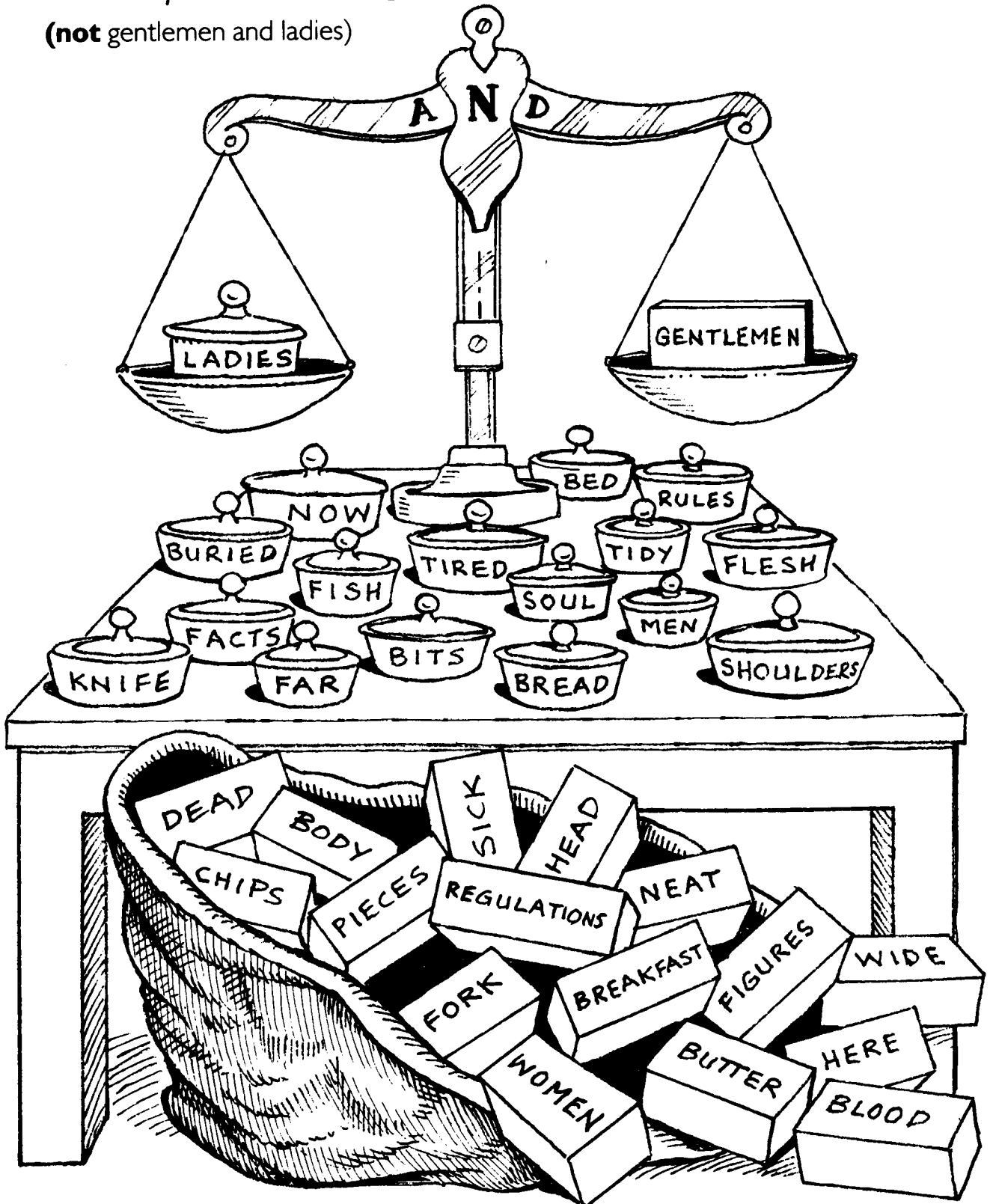

# Politics

In this word square there are 15 hidden words, all connected with POLITICS.

The words are horizontal , vertical , or diagonal 

For example:

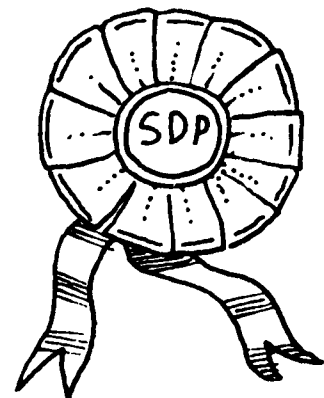
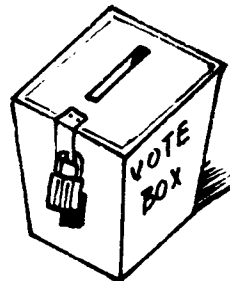
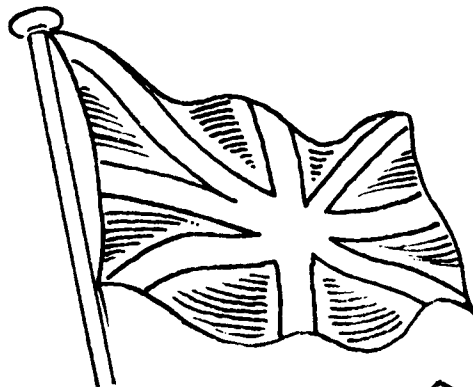
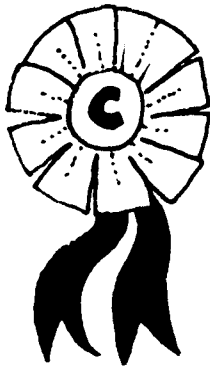
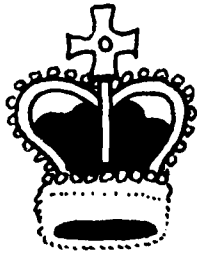

P	G	O	V	E	R	N	M	E	N	T	P
A	C	E	D	H	M	Y	O	L	S	L	O
R	R	O	E	U	V	J	N	E	O	S	W
L	E	Q	M	R	M	I	A	C	C	T	Z
I	P	T	O	M	H	L	R	T	I	A	K
A	U	Q	C	S	U	P	C	I	A	T	N
M	B	T	R	U	R	N	H	O	L	E	O
E	L	R	A	S	G	U	I	N	I	S	T
N	I	E	C	D	F	L	K	S	S	Y	K
T	C	C	Y	A	F	X	L	J	T	W	U
O	M	I	N	I	S	T	E	R	I	J	T
C	O	N	S	E	R	V	A	T	I	V	E
V	B	S	Z	C	B	P	D	S	M	Z	F
P	O	O	R	V	Q	A	E	D	E	Y	C
B	G	T	A	O	T	Y	R	D	L	N	R
L	I	B	E	R	A	L	X	I	G	H	E

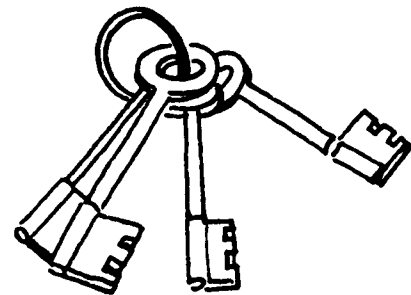
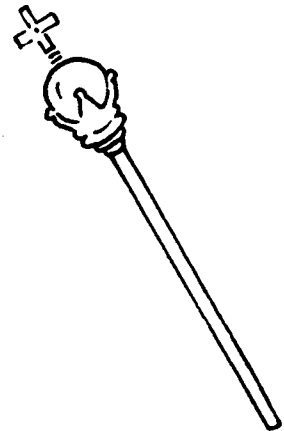
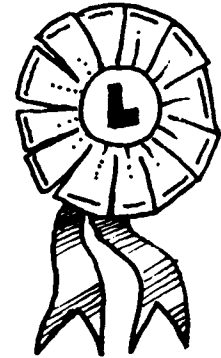









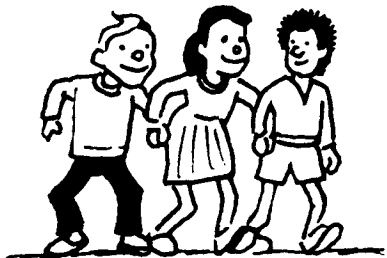

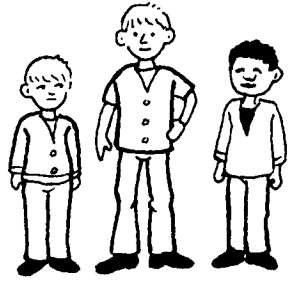
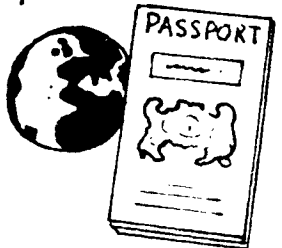
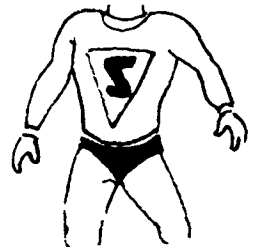
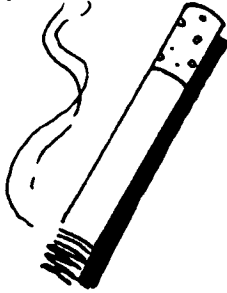
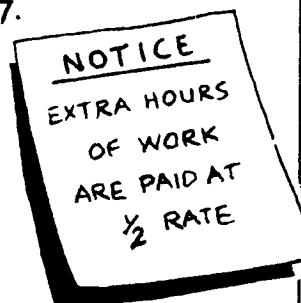
# PREFIXES AND SUFFIXES

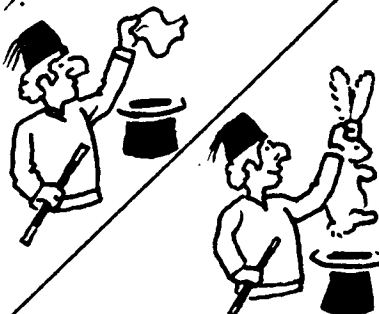
Here are 7 prefixes: MID- MIS- OVER- SUPER- TRANS- INTER- UN-

and 7 suffixes: -ETTE -HOOD -ISH -ITY -LY -NESS -SHIP

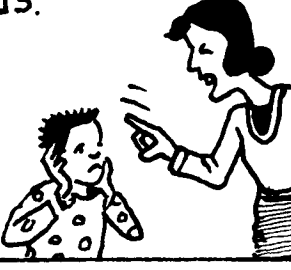
Can you put them in the correct place? Some can be used twice.

<p>1.</p>  <p><i>For example:</i> FRIENDSHIP</p>	<p>2.</p>  <p>GOOD</p>	<p>3.</p>  <p>TALL</p>	
<p>4.</p>  <p>NATIONAL</p>	<p>5.</p>  <p>MAN</p>	<p>6.</p>  <p>CIGAR</p>	<p>7.</p>  <p>TIME</p>
<p>8.</p>  <p>DO</p>	<p>9.</p>  <p>FORM</p>		<p>10.</p>  <p>POPULAR</p>
<p>11.</p>  <p>JULY</p>	<p>12.</p>  <p>MOTHER</p>	<p>13.</p>  <p>BEHAVE</p>	<p>14.</p>  <p>KIND</p>

# Prepositions

Do you know these 12 prepositional phrases?

Match the pictures with the correct prepositions.

There are 4 with BY, 4 with ON and 4 with OUT OF.

For example: 1. By oneself.

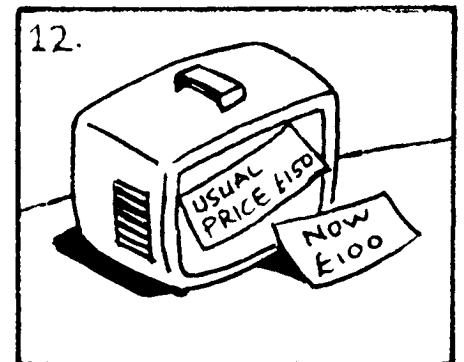
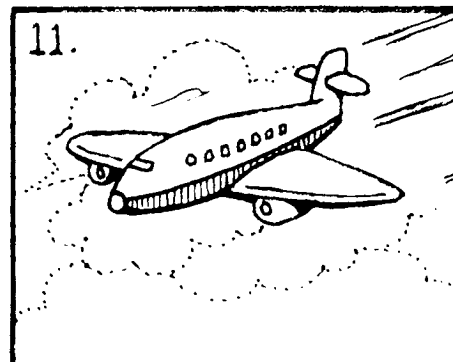
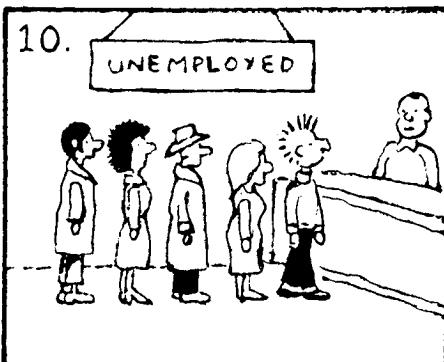
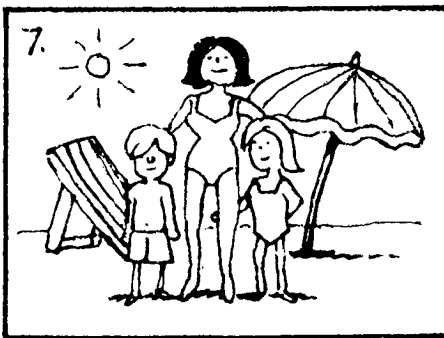
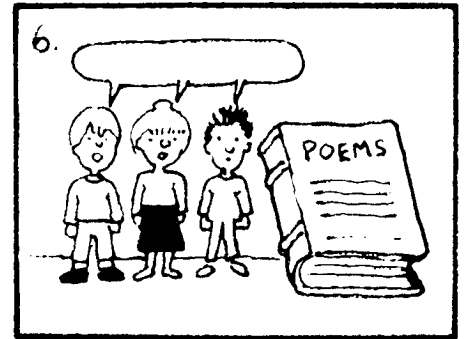
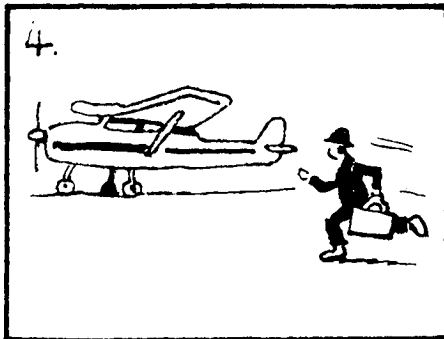
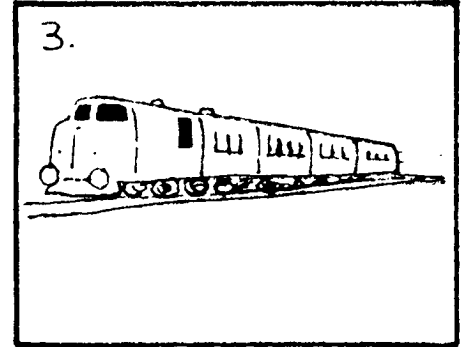
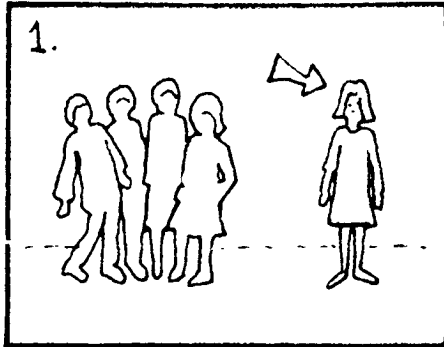

heart date business doors train work oneself fire air  
 holiday reach sale

# Rainbow

Can you find the compounds?

Each group begins with the same word.

1.

BOW

For example: 1. Rain

i.e. Rainbow, Raincoat, Rainfall.

2.

RISE

SET

COAT

3.

WIFE

SHINE

4.

CRAFT

HOLD

FALL

5.

CLOTHES

LINE

WORK

DAY

6.

PASTE

SIDE

MAIL

LIGHT

7.

CLOTH

ACHE

ROOM

PORT

TENNIS

BRUSH

SITTER



# SORT THEM OUT 1.

Decide whether these words are nouns or verbs, or whether they can be both. Then sort out the 3 categories.

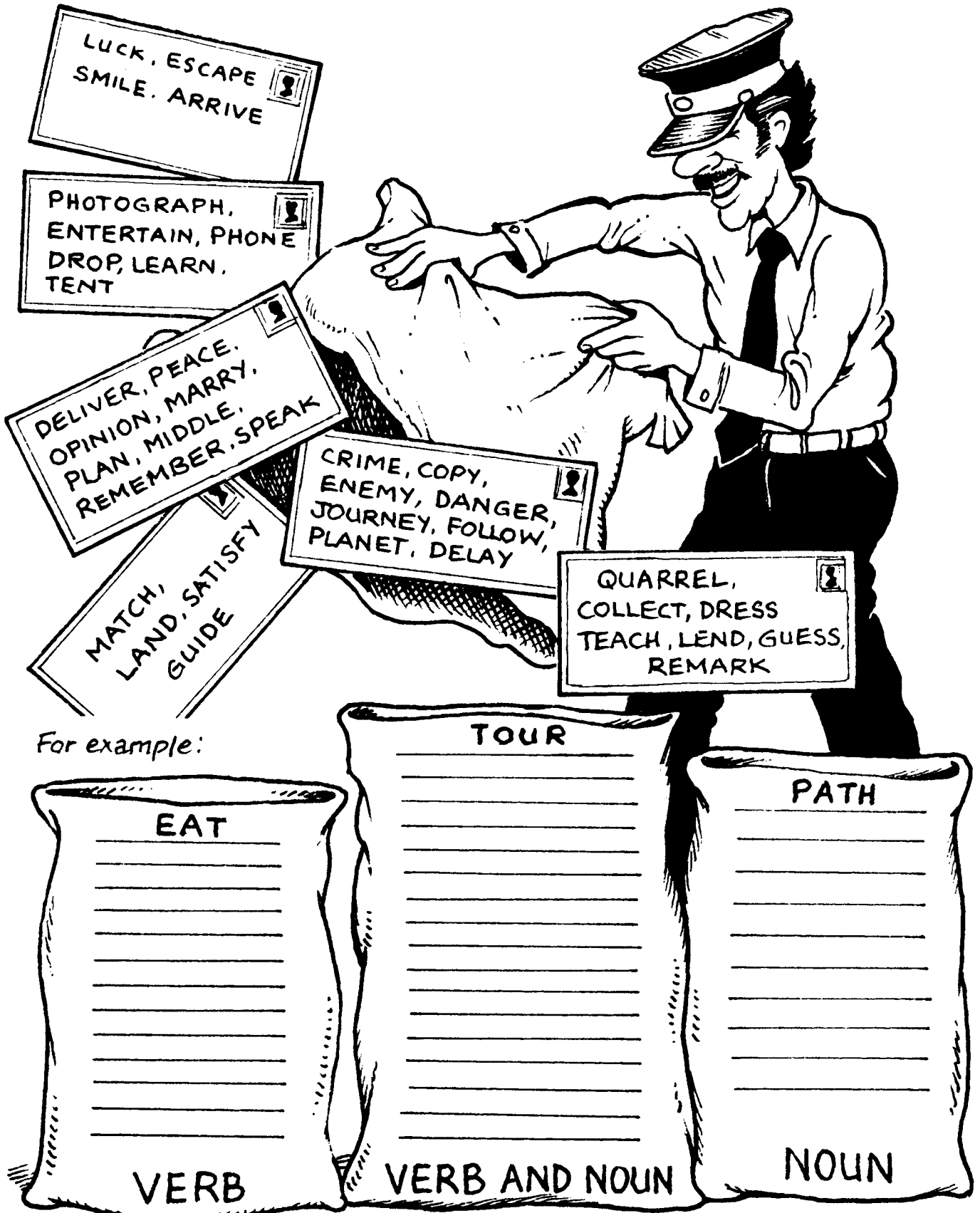

# SORT THEM OUT 2

Here are 25 words which all end in -LY.

Decide whether they are adverbs or adjectives, or whether they can be both.

Then sort out the 3 categories.

ADVERB	ADVERB & ADJECTIVE	ADJECTIVE
<i>For example:</i> <div data-bbox="240 712 520 786" style="border: 1px solid black; padding: 5px; text-align: center;">LATELY</div>	<div data-bbox="628 712 932 786" style="border: 1px solid black; padding: 5px; text-align: center;">EARLY</div>	<div data-bbox="1048 712 1335 786" style="border: 1px solid black; padding: 5px; text-align: center;">LOVELY</div>
<div data-bbox="161 1263 384 1346" style="border: 1px solid black; padding: 5px; text-align: center;">LIVELY</div> <div data-bbox="161 1361 464 1444" style="border: 1px solid black; padding: 5px; text-align: center;">HAPPILY</div> <div data-bbox="161 1460 464 1543" style="border: 1px solid black; padding: 5px; text-align: center;">YEARLY</div> <div data-bbox="201 1570 248 1816" style="writing-mode: vertical-rl; transform: rotate(180deg); border: 1px solid black; padding: 5px;">MONTHLY</div> <div data-bbox="360 1570 504 1794" style="writing-mode: vertical-rl; transform: rotate(180deg); border: 1px solid black; padding: 5px;">TIGHT</div> <div data-bbox="360 1816 536 1861" style="border: 1px solid black; padding: 5px; text-align: center;">BADLY</div> <div data-bbox="344 1883 552 1928" style="border: 1px solid black; padding: 5px; text-align: center;">NEARLY</div> <div data-bbox="328 1951 536 1995" style="border: 1px solid black; padding: 5px; text-align: center;">MERELY</div> <div data-bbox="185 1682 360 2085" style="writing-mode: vertical-rl; transform: rotate(180deg); border: 1px solid black; padding: 5px;">UNFORTUNATELY</div>	<div data-bbox="571 1137 922 2112" style="text-align: center;">  </div>	<div data-bbox="1134 1227 1358 1310" style="border: 1px solid black; padding: 5px; text-align: center;">SILLY</div> <div data-bbox="1066 1332 1406 1415" style="border: 1px solid black; padding: 5px; text-align: center;">REALLY</div> <div data-bbox="1134 1438 1358 1482" style="border: 1px solid black; padding: 5px; text-align: center;">ONLY</div> <div data-bbox="1000 1505 1422 1550" style="border: 1px solid black; padding: 5px; text-align: center;">CURLY DAILY</div> <div data-bbox="1066 1572 1358 1617" style="border: 1px solid black; padding: 5px; text-align: center;">UNLIKELY</div> <div data-bbox="1000 1639 1358 1908" style="writing-mode: vertical-rl; transform: rotate(180deg); border: 1px solid black; padding: 5px;">ACTUALLY</div> <div data-bbox="1000 1662 1198 1796" style="writing-mode: vertical-rl; transform: rotate(180deg); border: 1px solid black; padding: 5px;">HARDLY</div> <div data-bbox="1048 1706 1262 1908" style="writing-mode: vertical-rl; transform: rotate(180deg); border: 1px solid black; padding: 5px;">WEEKLY</div> <div data-bbox="1134 1930 1278 1975" style="border: 1px solid black; padding: 5px; text-align: center;">UGLY</div> <div data-bbox="1000 1998 1278 2042" style="border: 1px solid black; padding: 5px; text-align: center;">SLIGHTLY</div> <div data-bbox="1326 1774 1390 2042" style="writing-mode: vertical-rl; transform: rotate(180deg); border: 1px solid black; padding: 5px;">FAIRLY</div>

# STATISTICS

Fill in the missing words to complete this information about the northern island of Hebrodonia.

For example: 1. Males.

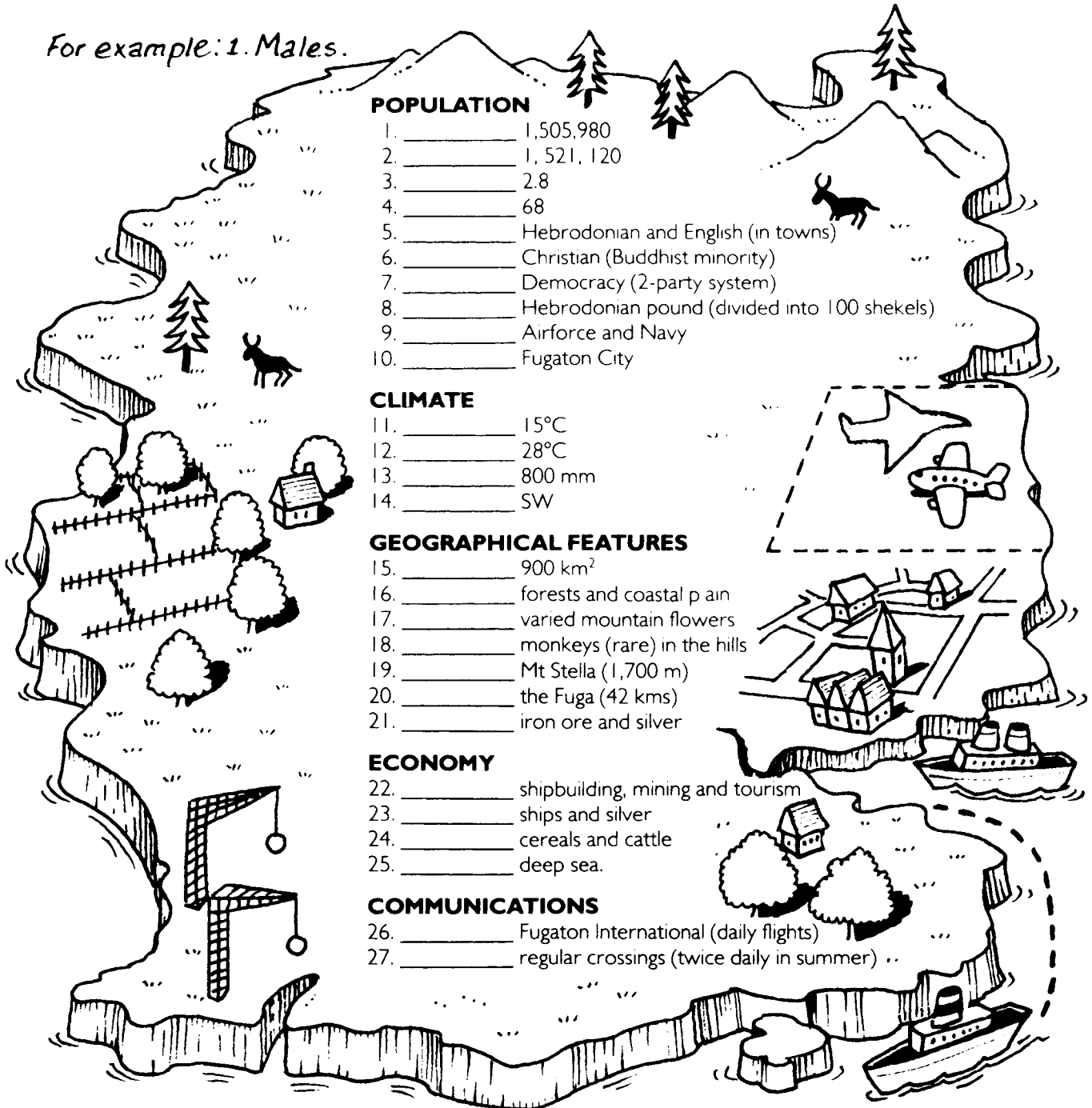

## POPULATION

1. \_\_\_\_\_ 1,505,980
2. \_\_\_\_\_ 1,521,120
3. \_\_\_\_\_ 2.8
4. \_\_\_\_\_ 68
5. \_\_\_\_\_ Hebrodonian and English (in towns)
6. \_\_\_\_\_ Christian (Buddhist minority)
7. \_\_\_\_\_ Democracy (2-party system)
8. \_\_\_\_\_ Hebrodonian pound (divided into 100 shekels)
9. \_\_\_\_\_ Airforce and Navy
10. \_\_\_\_\_ Fugaton City

## CLIMATE

11. \_\_\_\_\_ 15°C
12. \_\_\_\_\_ 28°C
13. \_\_\_\_\_ 800 mm
14. \_\_\_\_\_ SW

## GEOGRAPHICAL FEATURES

15. \_\_\_\_\_ 900 km<sup>2</sup>
16. \_\_\_\_\_ forests and coastal plain
17. \_\_\_\_\_ varied mountain flowers
18. \_\_\_\_\_ monkeys (rare) in the hills
19. \_\_\_\_\_ Mt Stella (1,700 m)
20. \_\_\_\_\_ the Fuga (42 kms)
21. \_\_\_\_\_ iron ore and silver

## ECONOMY

22. \_\_\_\_\_ shipbuilding, mining and tourism
23. \_\_\_\_\_ ships and silver
24. \_\_\_\_\_ cereals and cattle
25. \_\_\_\_\_ deep sea.

## COMMUNICATIONS

26. \_\_\_\_\_ Fugaton International (daily flights)
27. \_\_\_\_\_ regular crossings (twice daily in summer) ..

Males Fauna Fishing Average temperature (winter) Airport Relief  
 Capital city Official languages River Industry Females  
 Average rainfall Agriculture Ferry Government Life expectancy  
 Average number of children per family Main exports Highest mountain  
 Prevailing winds Armed services Flora Average temperature (summer)  
 Currency Religion Surface area Mineral deposits

# Train of thought

Work out the link between the first two words and then find a similar link to finish the sentence.

For example:

- 1 *Clock* is to *tick* as *dog* is to:  
a roar b grunt c growl d buzz
- 2 *Man* is to *chap* as *child* is to:  
a friend b pal c kid d guy
- 3 *Blunt* is to *sharpen* as *loose* is to:  
a tighten b find c lengthen d paint
- 4 *Football* is to *pitch* as *running* is to:  
a course b track c court d field
- 5 *Students* are to *lodgings* as *prisoners* are to:  
a barracks b inns c hutches d cells
- 6 *Cows* are to *cattle* as *hens* are to:  
a crops b dairy c game d poultry
- 7 *Worthless* is to *priceless* as *wild* is to:  
a rare b tame c savage d dangerous
- 8 *Sight* is to *blind* as *speech* is to:  
a dumb b hearing c deaf d lame
- 9 *The Thames* is to *river* as *Mars* is to:  
a Venus b star c zodiac d planet
- 10 *Cow* is to *calf* as *cat* is to:  
a puppy b kitten c cub d colt
- 11 *Ireland* is to *Irish* as *Scotland* is to:  
a Scotch b Scottish c Gaelic d tartan
- 12 *Stubborn* is to *obstinate* as *strange* is to:  
a awkward b nasty c odd d foolist
- 13 *Goats* are to *herd* as *wolves* are to:  
a flock b troop c swarm d pack
- 14 *Novel* is to *author* as *opera* is to:  
a singer b musician c composer d conductor

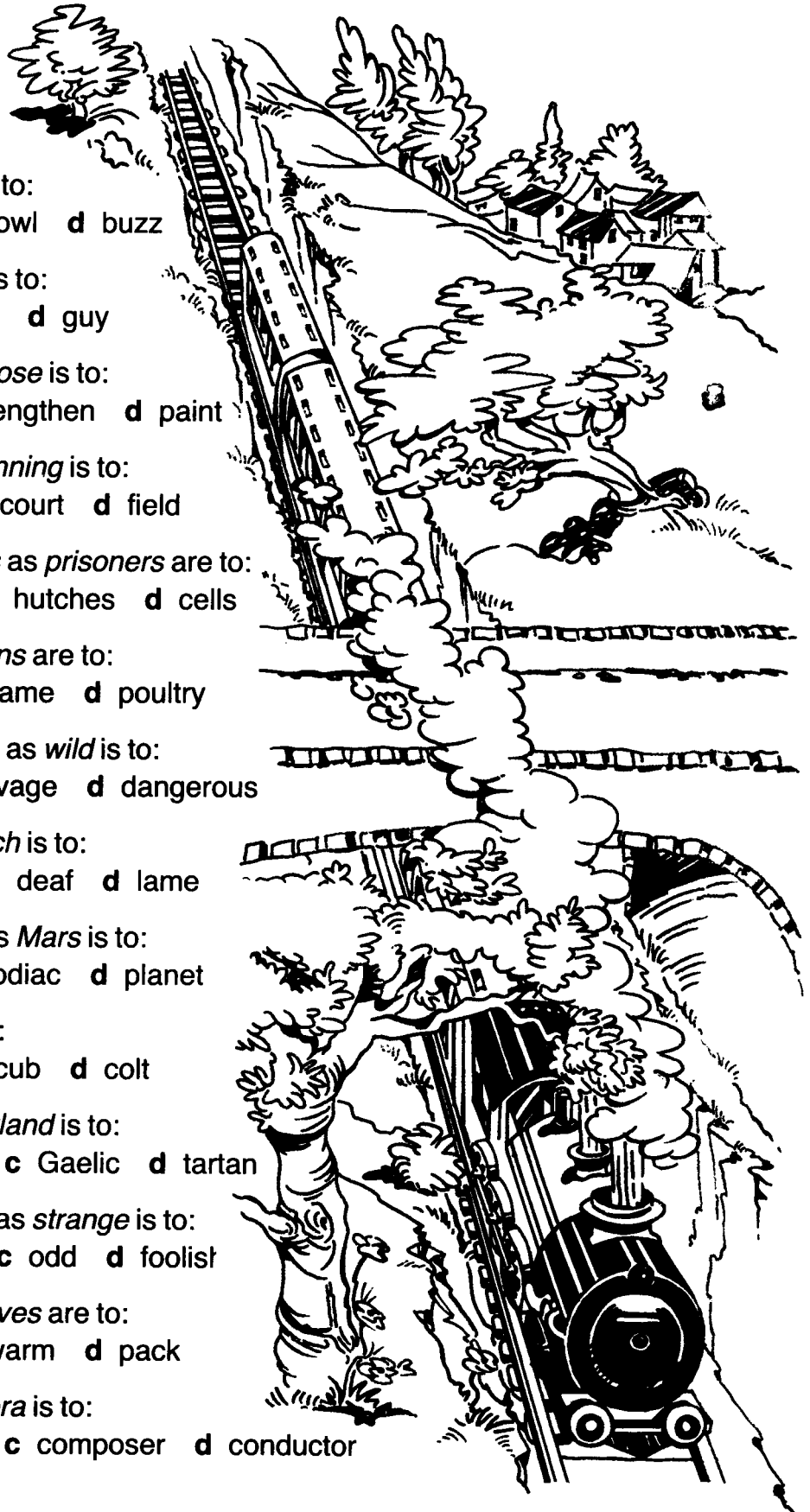

# The Travel

Travel brochures use a certain style and vocabulary to make their hotels and resorts sound attractive. Look at the descriptions below and complete them using the words at the bottom of the page. Both hotels use the same 9 words.

For example:

## THE IMPERIAL HOTEL

(1) Situated \_\_\_\_\_ only five minutes from the Floral Square, (2) \_\_\_\_\_ the waterfront of the River Bari, a (3) \_\_\_\_\_ hotel with all (4) \_\_\_\_\_, including a (5) \_\_\_\_\_ ballroom used for all the important functions of the town. Patio gardens, rooftop restaurant serving (6) \_\_\_\_\_ dishes. Large (7) \_\_\_\_\_ bar, popular with the locals and residents makes a (8) \_\_\_\_\_ atmosphere in (9) \_\_\_\_\_ surroundings.

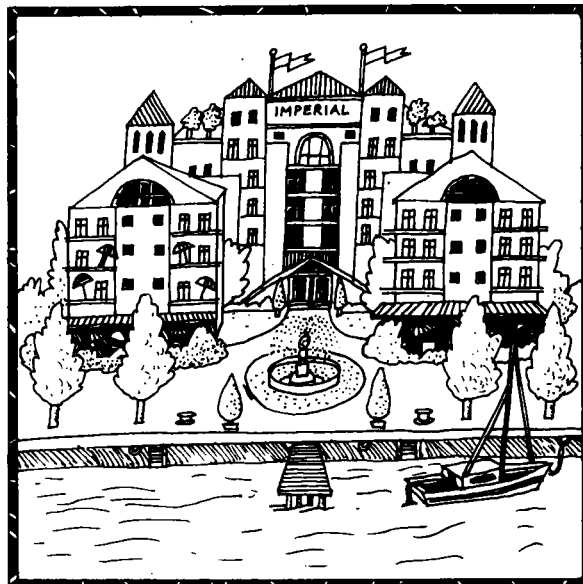

## THE CONTINENTAL HOTEL

Everything has been thought of to make your stay ( ) \_\_\_\_\_. All bedrooms have private ( ) \_\_\_\_\_ and look out onto a ( ) \_\_\_\_\_ courtyard.

(1) Situated \_\_\_\_\_ a few steps from the east canal, this hotel enjoys ( ) \_\_\_\_\_ views of the port and out to sea. The residents can enjoy, completely free of charge, the ( ) \_\_\_\_\_ Island Club ( ) \_\_\_\_\_ the hotel, which consists of a bar and ballroom. The ( ) \_\_\_\_\_ gamesroom is supervised by ( ) \_\_\_\_\_ and efficient staff.

well run    traditional    comfortable    close to    spectacular    luxury  
friendly    facilities    ~~situated~~

# Brochure

Both these descriptions of beauty spots also have 9 words missing which are the same. Find the pairs by fitting the letters together to make the words.

For example: l = features

## Cirali

The distinctive (1) f-a-u-e- of Cirali are its much-valued historical, architectural and artistic treasures. Built around a steep hill (2) s-r-o-n-e- by undulating valleys, Cirali occupies a (3) r-m-r-a-l- position in the heart of the countryside. The (4) r-n-e of monuments to be seen is impressive—much is (5) p-e-e-v-d of all the ages, a true history book of the past (6) l-n-e- to our present civilisation. Modern (7) d-v-l-p-e-t has not interfered with the ancient town of steep streets and (8) a-l-y-a-s, just as the (9) v-n-y-r-s have not interfered with the fields of wheat.



## Lasyp

Lasyp is a ( ) -e-a-k-b-e mediaeval town untouched by recent ( ) -e-l-o-m-n- ( ) -u-r-u-d-d by rocky mountains it is sometimes called 'The City of Silence'. The narrow, picturesque streets are ( ) -i-k-d by winding ( ) -l-e-w-y-. The town hall, with its well- ( ) -r-s-r-e- tablets giving information about certain (1) -e-t-r-s of the old legal system is well worth a visit and from its bell-tower unfolds a ( ) -a-g- of magnificent views, from ( ) -i-e-a-d- to ancient ruins.

# Verb Gymnastics

Find a verb that will go with the 3 words given in any one box.

For example:

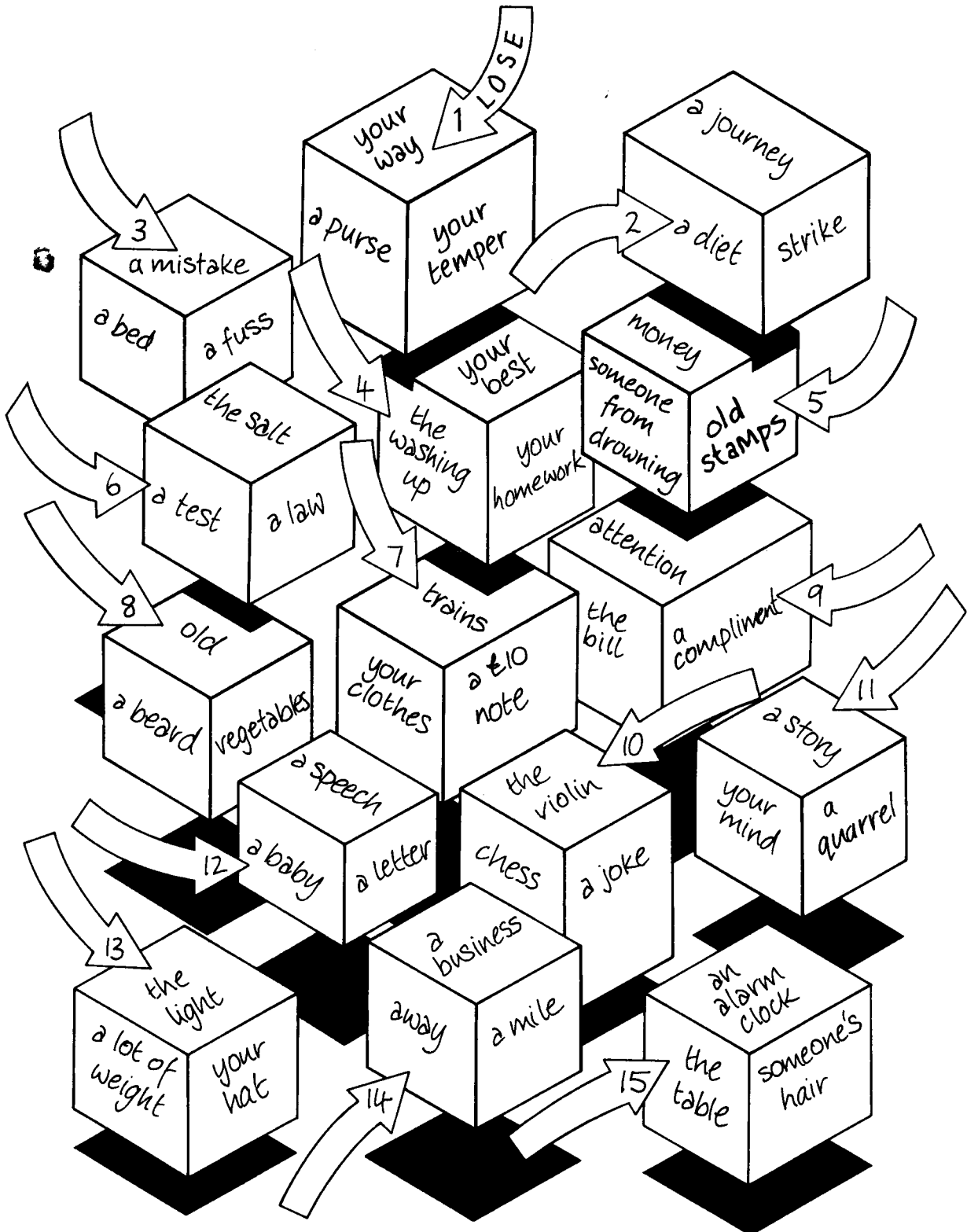

# VERB PIECES

A lot of English verbs are made of 2 parts, a verb and a preposition.  
Look at the pictures and then choose the correct parts from A and B to describe them.

For example: 1. Hand out

1.

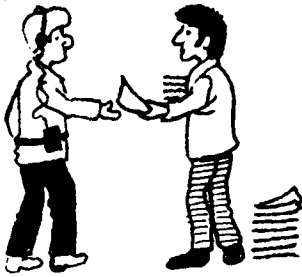

2.



3.

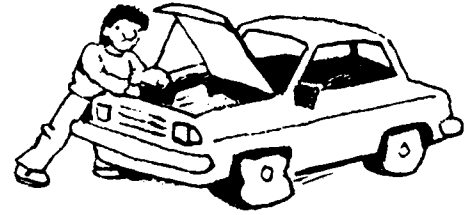

8.



A	B
hand	for
look	off
throw	away
call	for
get	back
write	down
give	out
break	down

4.

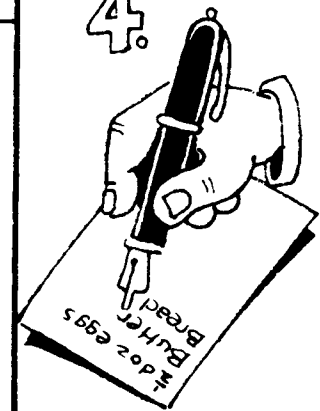

7.

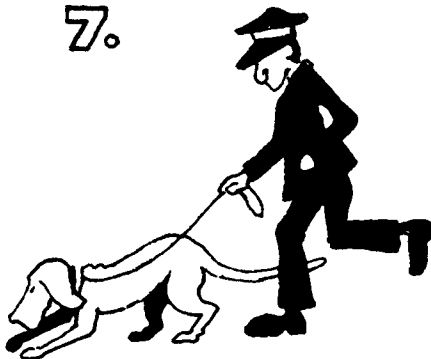

6.



5.





# What's it for?

Here are 12 useful objects. Identify the pictures and, using the words below, describe what they are used for.

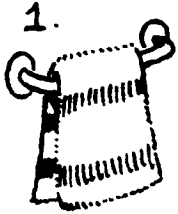

For example:

1. A towel is for drying



2. \_\_\_\_\_



3. \_\_\_\_\_

4. \_\_\_\_\_

5. \_\_\_\_\_

6. \_\_\_\_\_

7. \_\_\_\_\_

8. \_\_\_\_\_

9. \_\_\_\_\_

10. \_\_\_\_\_

11. \_\_\_\_\_

12. \_\_\_\_\_

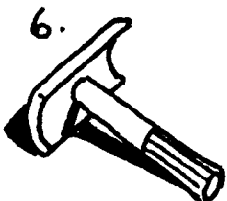
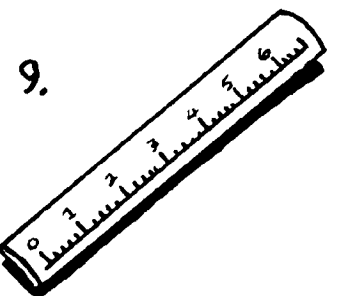
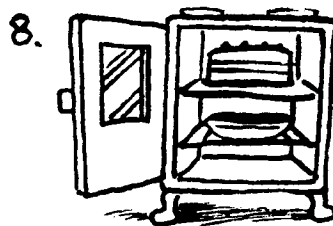
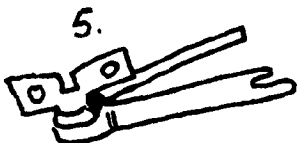
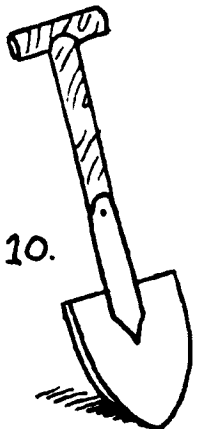
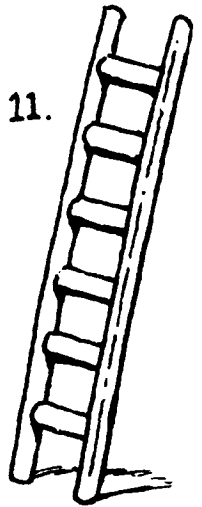
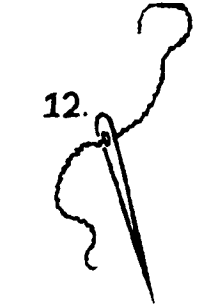
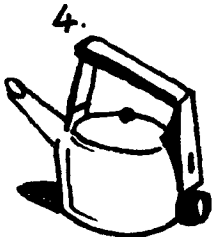

dry open press dig boil stir sew  
stick measure bake shave climb

# What's on

On these T.V. screens, you can see excerpts from an evening's viewing on several different channels. The titles of the programmes watched by Adrian and by Elizabeth will enable you to identify what each of them saw. Match the screens to the titles then number the screens accordingly. Then look at the group of words on the page opposite. All these words are connected with T.V.

For example:



# TV Tonight?

**ADRIAN** watched the following programmes: 1 The World Tonight: An Up-to-the-Minute Report 2 Is it Really a Bargain? Two Teams of Antiques Experts Compete. 3 Top of the Pops—This Week's Best-Selling Singles. 4 Use Your Vote Wisely. A Message from the Leader of the Opposition. 5 Wish on a Star: A Galaxy of Top Entertainers. 6 The Masked Raiders' Revenge: Will give you Nightmares! Don't watch alone!

**ELIZABETH** watched the following programmes: 7 The Open University Foundation Course. 8 Athletics: Highlights from the Qualifying Rounds. 9 Never a Dull Moment with Desmond the Duck: Fun for Young and Old. 10 The European Economic Community: A Closer Look. 11 I.Q. Challenge: Beat the Clock to Win the Jackpot. 12 Evening Worship: Prayers and Thanksgiving.

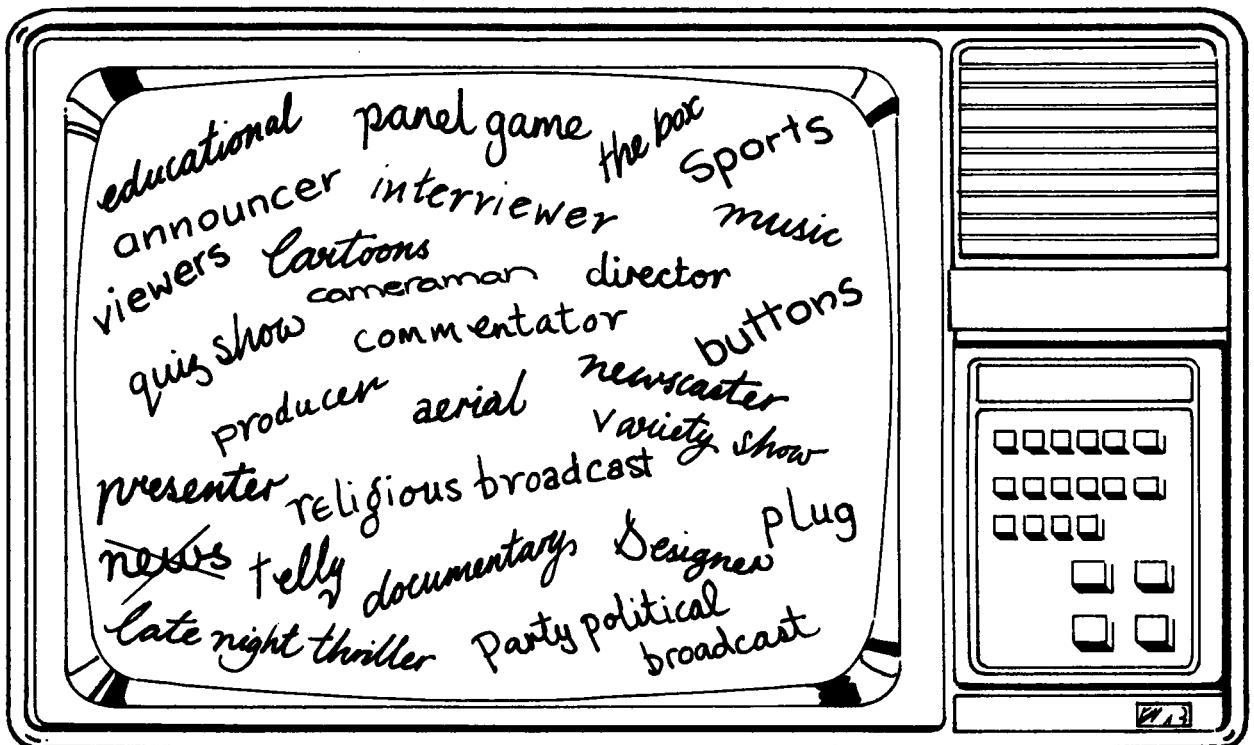

First cross out the 12 words or expressions which describe the 12 different types of programme you have just identified on the previous page. Then cross out:

- 5 people who appear on the screen
- 4 people who work behind the scenes
- 3 parts of a television
- 2 slang words for television
- 1 word for those who watch

# Answers

## Shopping List I

### Page 6

Potatoes, fish, milk, bread, cheese, butter, apples, meat.

## Who?

### Page 7

1. This is my wife and son.
2. This is my father and mother.
3. This is my grandfather and grandmother.
4. This is my brother.
5. This is my sister.
6. This is my dog.

## Crossword I – Colours

### Page 8

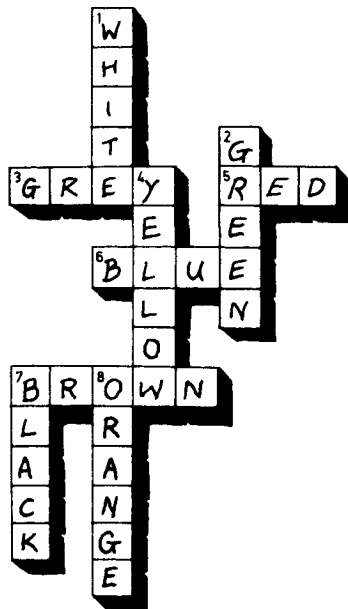

## Where?

### Page 9

1. She's in the dining room.
2. He's in the sitting room.
3. He's in the bathroom.
4. He's in the garden.
5. She's in the bedroom.
6. He's in the garage.
7. She's in the kitchen.

## The New House

### Page 10

Kitchen: cup, fork, knife, plate, fridge, spoon, teapot  
Bedroom: sheet, carpet, bed, blanket, pillow

## Food and Drink

### Page 11

Diana: soup of the day, omelette, chips, orange juice  
Peter: cake, biscuits, tea  
Ruth: cheese sandwich, banana, beer  
Ted: roast chicken, rice, wine, chocolate ice-cream, coffee

## Places I

### Page 12

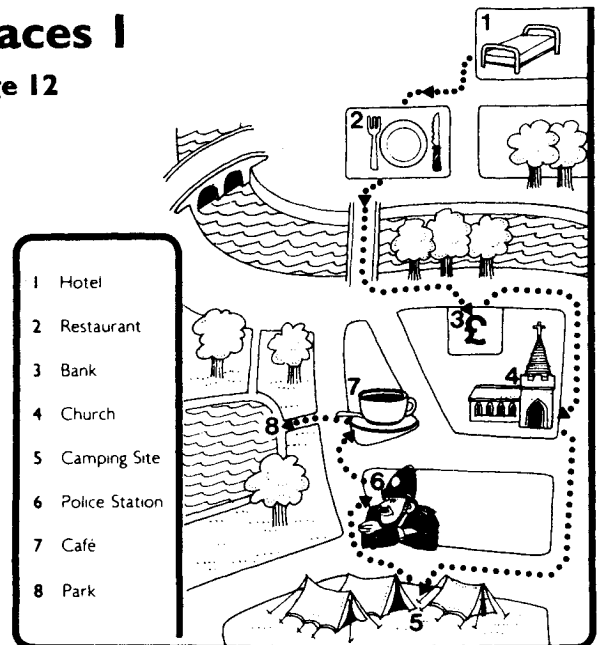

## Top Secret

### Page 13

Train, On (foot), Motorbike, Station, Airport, Taxi, Plane, Underground, Bicycle. TOM'S AT THE PUB

## Holiday List

### Page 14



# Verb Game I

Page 15

R	T	T	F	S	L	I	N	R	O
P	O	H	L	I	I	F	S	H	E
V	E	I	G	Q	S	G	I	V	E
W	C	N	M	U	T	A	T	B	A
A	L	K	V	P	E	S	K	A	T
I	E	O	S	I	N	G	P	O	C
T	A	L	K	A	Z	I	M	E	H
D	N	S	Z	J	E	O	O	U	J
Q	A	P	V	T	K	S	T	O	P

## At the Station

Page 16

- |               |                          |
|---------------|--------------------------|
| 1. Taxis      | 8. Travel Centre         |
| 2. Way Out    | 9. Closed                |
| 3. Toilets    | 10. Ticket Office        |
| 4. Telephones | 11. Waiting Room         |
| 5. Platform I | 12. Lost Property Office |
| 6. Danger     | 13. Open                 |
| 7. Bar        |                          |

## Abbreviations I

Page 18

a.m.	ante meridiem (in the morning)
G.B.	Great Britain
lb	pound (weight)
U.S.	United States
P.T.O.	please turn over
m	metre
Sun.	Sunday
Fri.	Friday
N.	north
Mon.	Monday
p.m.	post meridiem (in the afternoon)
USA	United States of America
Sat.	Saturday
NE	northeast
Km	kilometre
UK	United Kingdom
USSR	Union of Soviet Socialist Republics
Kg	kilogram
U.N.	United Nations

## Doubles I

Page 19

first name, departure lounge, telephone box, bus station, camping site, shopping list, orange juice, ground floor, telephone number

## Free Time

Page 20

Mr Jones: dancing, playing football, reading, cooking, watching television  
Mrs Smith: walking, learning foreign languages, driving, swimming, listening to music

## Legs

Page 21

Three dogs	twelve	Legs	12
Four cats	sixteen	Legs	16
One farmer & two horses	ten	Legs	10
One bird	two	Legs	2
One fly	six	Legs	6
One tourist guide & fourteen tourists	thirty	Legs	30
Two chairs	eight	Legs	8
Four tables	sixteen	Legs	16
Mr & Mrs Brown & their three daughters	ten	Legs	10
Total	One hundred and ten	Legs	110

## Opposites I

Page 22

9	Dark	Light	1
2	Cheap	Expensive	8
3	Quiet	Noisy	10
4	High	Low	14
6	Old	New	12
7	Young	Old	13
11	Heavy	Light	5

## Help

Page 23

Hers: money, map, car keys, notebook, pen, cheque book

His: ball, bottle of water, boat, book, sunglasses, hat, radio, towel

## What's the Matter?

Page 24

1. He's tired.
2. He's fallen on the ice.
3. He's got a cold.
4. He's thirsty.
5. He's hungry.
6. He's cut his finger.
7. He's broken his arm.
8. He's got a pain in his back.
9. He's burnt his hand.
10. He's ill.

## At the Hotel

Page 25

- |               |               |               |
|---------------|---------------|---------------|
| 1. Breakfast  | 5. Change     | 9. Parking    |
| 2. Restaurant | 6. Doctor     | 10. Check-out |
| 3. Bar        | 7. Radio      | 11. Dogs      |
| 4. Telephone  | 8. Television | 12. Wake-up   |

## Circle Game

Page 26

Pay a bill, fly a plane, smoke a cigarette, book a hotel room, win a football match, send a letter, change a traveller's cheque, drive a truck

## Crossword 2 – The Body

Page 27

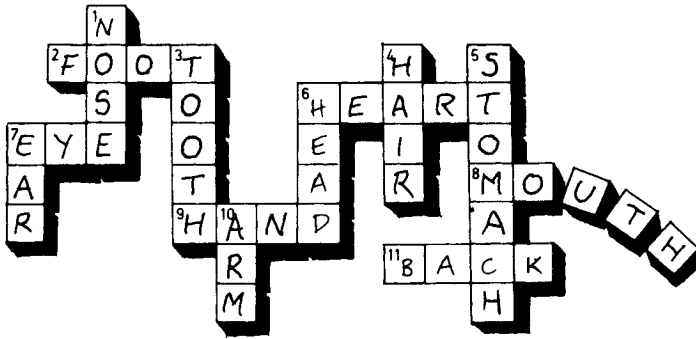

## Plurals

Page 28

- |             |               |
|-------------|---------------|
| 1. Women    | 9. Watches    |
| 2. Cars     | 10. Policemen |
| 3. Buses    | 11. Islands   |
| 4. Knives   | 12. Leaves    |
| 5. Teeth    | 13. Glasses   |
| 6. Combs    | 14. Flowers   |
| 7. Feet     | 15. Factories |
| 8. Children |               |

## Shopping List 2

Page 29

- |                         |                       |
|-------------------------|-----------------------|
| 1. A kilo of beans      | 6. A piece of cake    |
| 2. A bottle of wine     | 7. A loaf of bread    |
| 3. A packet of tea      | 8. A kilo of oranges  |
| 4. A packet of biscuits | 9. A piece of cheese  |
| 5. A can of beer        | 10. A packet of sugar |

## Doubles 2

Page 30

toothpaste, coffee-pot, weekend, football, livingroom, haircut, motorbike, toothbrush, bathroom, ice-cream, bedroom, postcard

## Verb Game 2

Page 31

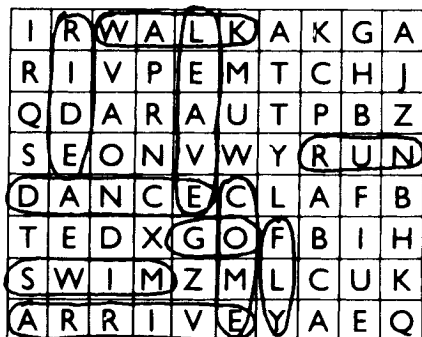

## What's the Weather Like Today?

Page 32

In India it is cloudy and hot.  
In Saudi Arabia it is dry and sunny.  
In Scotland there is rain and fog.  
In Alaska there is snow and wind.

## Help 2

Page 33

- |                      |                               |
|----------------------|-------------------------------|
| 1. There's no water. | 6. There's no heating.        |
| 2. There's no lift.  | 7. There's no chair.          |
| 3. There's no key.   | 8. There's no pillow.         |
| 4. There's no light. | 9. There's no knife and fork. |
| 5. There's no towel. |                               |

## Abbreviations 2

Page 34

Dec.	December
BC	Before Christ
P	Parking
P.S.	Postscript
S.	south
tel.	telephone
TV	television
Ave.	Avenue
Sq.	Square
Dr.	Doctor
NB	nota bene (take special note of)
SW	southwest
St.	Street
WC	water closet (toilet)
Rd.	Road
AD	anno Domini (in the year of our Lord)
wk	week
p.	pence
yr.	year

## Places 2

Page 35

- He worked in a market.
- He worked in a factory.
- He worked in a cinema.
- He worked in a supermarket.
- He worked in a post office.
- He worked in an office.
- He worked in a ticket office.
- He worked in a hospital.

## Sports

### Page 55

**Individuals:** 4. waterskiing 5. fishing 7. running  
8. ice-skating 13. shooting 17. skiing  
18. diving

**2 or more people:** 1. squash 2. table tennis  
6. snooker 10. tennis 12. boxing  
16. badminton

**Teams:** 3. baseball 9. rugby 11. cricket  
14. basketball 15. hockey

## Station Signs

### Page 56

- |                                      |                             |
|--------------------------------------|-----------------------------|
| 1. luggage locker                    | 9. lost property            |
| 2. facilities for the<br>handicapped | 10. toilets and<br>washroom |
| 3. left luggage                      | 11. cafeteria               |
| 4. luggage trolleys                  | 12. buffet                  |
| 5. information                       | 13. drinking water          |
| 6. car rental                        | 14. meeting point           |
| 7. non-smokers                       | 15. waiting room            |
| 8. public telephone                  |                             |













## Word Families 3

### Page 57

- saucer, pot, dish, pan
- socialist, party member, minister, communist
- operator, directory, dial, call box
- wound, injury, disease, fever
- gale, thunderstorm, lightning, frost
- pair, couple, billion, dozen

## Map Reading

### Page 58

- |                 |   |              |   |
|-----------------|---|--------------|---|
| 1. canal        |  | 7. forest    |  |
| 2. coast        |  | 8. footpath  |  |
| 3. bridge       |  | 9. old wall  |  |
| 4. farmland     |  | 10. motorway |  |
| 5. castle       |  | 11. village  |  |
| 6. stone circle |  | 12. ferry    |  |

## The Application Form

### Page 59

- Family name
- Mr/Mrs/Miss/Ms
- First name
- Date of birth
- Place of birth
- Marital status
- Children
- Present address
- Tel. no.
- Education: schools attended
- Education: university/college
- Previous experience
- Present position
- Present salary
- Languages spoken
- Driving licence
- Interests
- Names and addresses of 2 referees
- Date available
- Date
- Signature

## A Picnic in the Country

### Page 60

	True	False
1. Someone's reading.	X	
2. Someone's swimming.		X
3. Someone's driving.		X
4. Someone's climbing.	X	
5. Someone's drinking.		X
6. Someone's riding.		X
7. Someone's resting.	X	
8. Someone's fighting.	X	
9. Someone's jumping.	X	
10. Someone's sewing.	X	
11. Someone's crying.	X	
12. Someone's shaving.		X
13. Someone's hurrying.		X
14. Someone's laughing.		X
15. Someone's hiding.	X	
16. Someone's standing.	X	
17. Someone's leaving.		X
18. Someone's shooting.		X
19. Someone's watching.	X	
20. Someone's running.		X

## Sports

### Page 55

**Individuals:** 4. waterskiing 5. fishing 7. running  
8. ice-skating 13. shooting 17. skiing  
18. diving

**2 or more people:** 1. squash 2. table tennis  
6. snooker 10. tennis 12. boxing  
16. badminton

**Teams:** 3. baseball 9. rugby 11. cricket  
14. basketball 15. hockey

## Station Signs

### Page 56

- |                                      |                             |
|--------------------------------------|-----------------------------|
| 1. luggage locker                    | 9. lost property            |
| 2. facilities for the<br>handicapped | 10. toilets and<br>washroom |
| 3. left luggage                      | 11. cafeteria               |
| 4. luggage trolleys                  | 12. buffet                  |
| 5. information                       | 13. drinking water          |
| 6. car rental                        | 14. meeting point           |
| 7. non-smokers                       | 15. waiting room            |
| 8. public telephone                  |                             |













## Word Families 3

### Page 57

- saucer, pot, dish, pan
- socialist, party member, minister, communist
- operator, directory, dial, call box
- wound, injury, disease, fever
- gale, thunderstorm, lightning, frost
- pair, couple, billion, dozen

## Map Reading

### Page 58

- |                 |   |              |   |
|-----------------|---|--------------|---|
| 1. canal        |  | 7. forest    |  |
| 2. coast        |  | 8. footpath  |  |
| 3. bridge       |  | 9. old wall  |  |
| 4. farmland     |  | 10. motorway |  |
| 5. castle       |  | 11. village  |  |
| 6. stone circle |  | 12. ferry    |  |

## The Application Form

### Page 59

- Family name
- Mr/Mrs/Miss/Ms
- First name
- Date of birth
- Place of birth
- Marital status
- Children
- Present address
- Tel. no.
- Education: schools attended
- Education: university/college
- Previous experience
- Present position
- Present salary
- Languages spoken
- Driving licence
- Interests
- Names and addresses of 2 referees
- Date available
- Date
- Signature

## A Picnic in the Country

### Page 60

	True	False
1. Someone's reading.	X	
2. Someone's swimming.		X
3. Someone's driving.		X
4. Someone's climbing.	X	
5. Someone's drinking.		X
6. Someone's riding.		X
7. Someone's resting.	X	
8. Someone's fighting.	X	
9. Someone's jumping.	X	
10. Someone's sewing.	X	
11. Someone's crying.	X	
12. Someone's shaving.		X
13. Someone's hurrying.		X
14. Someone's laughing.		X
15. Someone's hiding.	X	
16. Someone's standing.	X	
17. Someone's leaving.		X
18. Someone's shooting.		X
19. Someone's watching.	X	
20. Someone's running.		X



## Abbreviations 3

### Page 61

- BA – Bachelor of Arts
- MA – Master of Arts
- Ph.D – Doctor of Philosophy
- Dip. – Diploma
- Prof. – Professor
- Univ. – University
- max. – maximum
- min. – minimum
- VAT – value added tax
- vol. – volume
- maths. – mathematics
- BA – British Airways
- Capt. – Captain
- m.p.h. – miles per hour
- m.p.g. – miles per gallon
- Eng. – England
- govt. – government
- HQ – Headquarters
- Ltd. – Limited
- Co. – Company
- EU – European Union

## Opposites 4

### Page 62

- smooth – rough
- soft – hard
- thick – thin
- pleasant – unpleasant
- simple – difficult
- sweet – bitter
- strong – weak
- soft – loud
- comfortable – uncomfortable
- safe – dangerous
- interesting – boring
- antique – modern
- fine – rainy

## Crossword 4

### Page 63

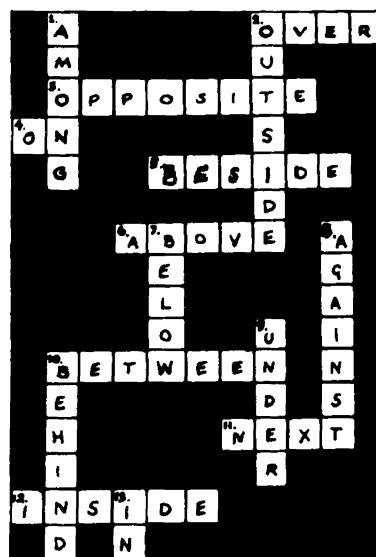

## Hotel Signs

### Page 64

- |                        |                           |
|------------------------|---------------------------|
| 1. Ring for service    | 7. Lounge                 |
| 2. Messages for guests | 8. Tours                  |
| 3. Check in here       | 9. Roof garden            |
| 4. Luggage             | 10. Manager               |
| 5. Laundry             | 11. Please do not disturb |
| 6. Porter              | 12. Swimming pool         |

# Answers

## Shopping List I

### Page 6

Potatoes, fish, milk, bread, cheese, butter, apples, meat.

## Who?

### Page 7

1. This is my wife and son.
2. This is my father and mother.
3. This is my grandfather and grandmother.
4. This is my brother.
5. This is my sister.
6. This is my dog.

## Crossword I – Colours

### Page 8

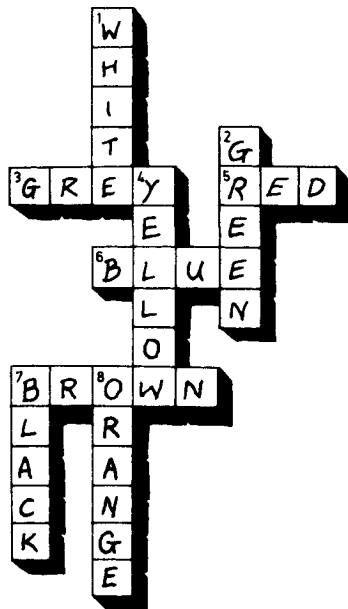

## Where?

### Page 9

1. She's in the dining room.
2. He's in the sitting room.
3. He's in the bathroom.
4. He's in the garden.
5. She's in the bedroom.
6. He's in the garage.
7. She's in the kitchen.

## The New House

### Page 10

Kitchen: cup, fork, knife, plate, fridge, spoon, teapot  
Bedroom: sheet, carpet, bed, blanket, pillow

## Food and Drink

### Page 11

Diana: soup of the day, omelette, chips, orange juice  
Peter: cake, biscuits, tea  
Ruth: cheese sandwich, banana, beer  
Ted: roast chicken, rice, wine, chocolate ice-cream, coffee

## Places I

### Page 12

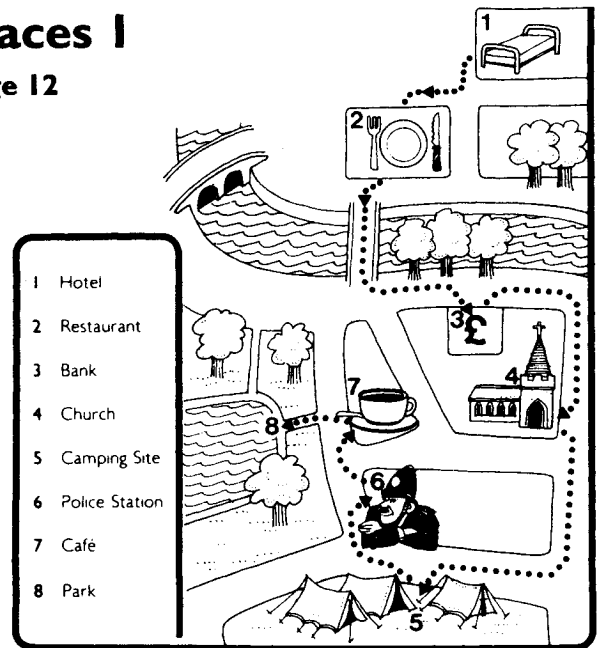

## Top Secret

### Page 13

Train, On (foot), Motorbike, Station, Airport, Taxi, Plane, Underground, Bicycle. TOM'S AT THE PUB

## Holiday List

### Page 14



# Answers

## Shopping List I

### Page 6

Potatoes, fish, milk, bread, cheese, butter, apples, meat.

## Who?

### Page 7

1. This is my wife and son.
2. This is my father and mother.
3. This is my grandfather and grandmother.
4. This is my brother.
5. This is my sister.
6. This is my dog.

## Crossword I – Colours

### Page 8

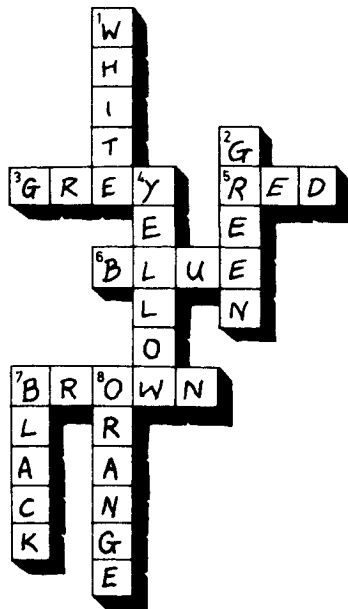

## Where?

### Page 9

1. She's in the dining room.
2. He's in the sitting room.
3. He's in the bathroom.
4. He's in the garden.
5. She's in the bedroom.
6. He's in the garage.
7. She's in the kitchen.

## The New House

### Page 10

Kitchen: cup, fork, knife, plate, fridge, spoon, teapot  
Bedroom: sheet, carpet, bed, blanket, pillow

## Food and Drink

### Page 11

Diana: soup of the day, omelette, chips, orange juice  
Peter: cake, biscuits, tea  
Ruth: cheese sandwich, banana, beer  
Ted: roast chicken, rice, wine, chocolate ice-cream, coffee

## Places I

### Page 12

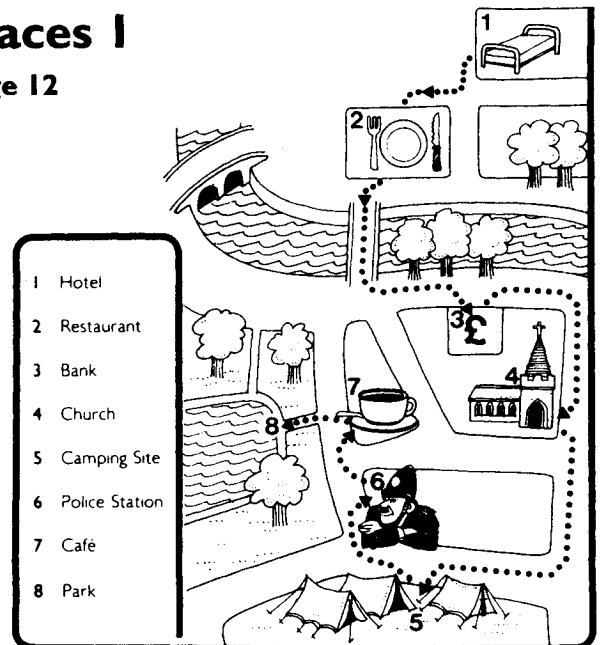

## Top Secret

### Page 13

Train, On (foot), Motorbike, Station, Airport, Taxi, Plane, Underground, Bicycle. TOM'S AT THE PUB

## Holiday List

### Page 14



# Verb Game I

Page 15

R	T	T	F	S	L	I	N	R	O
P	O	H	L	I	I	F	S	H	E
V	E	I	G	Q	S	G	I	V	E
W	C	N	M	U	T	A	T	B	A
A	L	K	V	P	E	S	K	A	T
I	E	O	S	I	N	G	P	O	C
T	A	L	K	A	Z	I	M	E	H
D	N	S	Z	J	E	O	O	U	J
Q	A	P	V	T	K	S	T	O	P

## At the Station

Page 16

- Taxis
- Way Out
- Toilets
- Telephones
- Platform I
- Danger
- Bar
- Travel Centre
- Closed
- Ticket Office
- Waiting Room
- Lost Property Office
- Open

## Abbreviations I

Page 18

a.m.	ante meridiem (in the morning)
G.B.	Great Britain
lb	pound (weight)
U.S.	United States
P.T.O.	please turn over
m	metre
Sun.	Sunday
Fri.	Friday
N.	north
Mon.	Monday
p.m.	post meridiem (in the afternoon)
USA	United States of America
Sat.	Saturday
NE	northeast
Km	kilometre
UK	United Kingdom
USSR	Union of Soviet Socialist Republics
Kg	kilogram
U.N.	United Nations

## Doubles I

Page 19

first name, departure lounge, telephone box, bus station, camping site, shopping list, orange juice, ground floor, telephone number

## Free Time

Page 20

Mr Jones: dancing, playing football, reading, cooking, watching television  
Mrs Smith: walking, learning foreign languages, driving, swimming, listening to music

## Legs

Page 21

Three dogs	twelve	Legs	12
Four cats	sixteen	Legs	16
One farmer & two horses	ten	Legs	10
One bird	two	Legs	2
One fly	six	Legs	6
One tourist guide & fourteen tourists	thirty	Legs	30
Two chairs	eight	Legs	8
Four tables	sixteen	Legs	16
Mr & Mrs Brown & their three daughters	ten	Legs	10
Total	One hundred and ten	Legs	110

## Opposites I

Page 22

9	Dark	Light	1
2	Cheap	Expensive	8
3	Quiet	Noisy	10
4	High	Low	14
6	Old	New	12
7	Young	Old	13
11	Heavy	Light	5

## Help

Page 23

Hers: money, map, car keys, notebook, pen, cheque book

His: ball, bottle of water, boat, book, sunglasses, hat, radio, towel

## What's the Matter?

Page 24

- He's tired.
- He's fallen on the ice.
- He's got a cold.
- He's thirsty.
- He's hungry.
- He's cut his finger.
- He's broken his arm.
- He's got a pain in his back.
- He's burnt his hand.
- He's ill.

## At the Hotel

Page 25

- Breakfast
- Restaurant
- Bar
- Telephone
- Change
- Doctor
- Radio
- Television
- Parking
- Check-out
- Dogs
- Wake-up

## Circle Game

Page 26

Pay a bill, fly a plane, smoke a cigarette, book a hotel room, win a football match, send a letter, change a traveller's cheque, drive a truck

# Verb Game I

Page 15

R	T	T	F	S	L	I	N	R	O
P	O	H	L	I	I	F	S	H	E
V	E	I	G	Q	S	G	I	V	E
W	C	N	M	U	T	A	T	B	A
A	L	K	V	P	E	S	K	A	T
I	E	O	S	I	N	G	P	O	C
T	A	L	K	A	Z	I	M	E	H
D	N	S	Z	J	E	O	O	U	J
Q	A	P	V	T	K	S	T	O	P

## At the Station

Page 16

- |               |                          |
|---------------|--------------------------|
| 1. Taxis      | 8. Travel Centre         |
| 2. Way Out    | 9. Closed                |
| 3. Toilets    | 10. Ticket Office        |
| 4. Telephones | 11. Waiting Room         |
| 5. Platform I | 12. Lost Property Office |
| 6. Danger     | 13. Open                 |
| 7. Bar        |                          |

## Abbreviations I

Page 18

a.m.	ante meridiem (in the morning)
G.B.	Great Britain
lb	pound (weight)
U.S.	United States
P.T.O.	please turn over
m	metre
Sun.	Sunday
Fri.	Friday
N.	north
Mon.	Monday
p.m.	post meridiem (in the afternoon)
USA	United States of America
Sat.	Saturday
NE	northeast
Km	kilometre
UK	United Kingdom
USSR	Union of Soviet Socialist Republics
Kg	kilogram
U.N.	United Nations

## Doubles I

Page 19

first name, departure lounge, telephone box, bus station, camping site, shopping list, orange juice, ground floor, telephone number

## Free Time

Page 20

Mr Jones: dancing, playing football, reading, cooking, watching television  
Mrs Smith: walking, learning foreign languages, driving, swimming, listening to music

## Legs

Page 21

Three dogs	twelve	Legs	12
Four cats	sixteen	Legs	16
One farmer & two horses	ten	Legs	10
One bird	two	Legs	2
One fly	six	Legs	6
One tourist guide & fourteen tourists	thirty	Legs	30
Two chairs	eight	Legs	8
Four tables	sixteen	Legs	16
Mr & Mrs Brown & their three daughters	ten	Legs	10
Total	One hundred and ten	Legs	110

## Opposites I

Page 22

9	Dark	Light	1
2	Cheap	Expensive	8
3	Quiet	Noisy	10
4	High	Low	14
6	Old	New	12
7	Young	Old	13
11	Heavy	Light	5

## Help

Page 23

Hers: money, map, car keys, notebook, pen, cheque book

His: ball, bottle of water, boat, book, sunglasses, hat, radio, towel

## What's the Matter?

Page 24

1. He's tired.
2. He's fallen on the ice.
3. He's got a cold.
4. He's thirsty.
5. He's hungry.
6. He's cut his finger.
7. He's broken his arm.
8. He's got a pain in his back.
9. He's burnt his hand.
10. He's ill.

## At the Hotel

Page 25

- |               |               |               |
|---------------|---------------|---------------|
| 1. Breakfast  | 5. Change     | 9. Parking    |
| 2. Restaurant | 6. Doctor     | 10. Check-out |
| 3. Bar        | 7. Radio      | 11. Dogs      |
| 4. Telephone  | 8. Television | 12. Wake-up   |

## Circle Game

Page 26

Pay a bill, fly a plane, smoke a cigarette, book a hotel room, win a football match, send a letter, change a traveller's cheque, drive a truck

## Sports

### Page 55

**Individuals:** 4. waterskiing 5. fishing 7. running  
8. ice-skating 13. shooting 17. skiing  
18. diving

**2 or more people:** 1. squash 2. table tennis  
6. snooker 10. tennis 12. boxing  
16. badminton

**Teams:** 3. baseball 9. rugby 11. cricket  
14. basketball 15. hockey

## Station Signs

### Page 56

- |                                      |                             |
|--------------------------------------|-----------------------------|
| 1. luggage locker                    | 9. lost property            |
| 2. facilities for the<br>handicapped | 10. toilets and<br>washroom |
| 3. left luggage                      | 11. cafeteria               |
| 4. luggage trolleys                  | 12. buffet                  |
| 5. information                       | 13. drinking water          |
| 6. car rental                        | 14. meeting point           |
| 7. non-smokers                       | 15. waiting room            |
| 8. public telephone                  |                             |













## Word Families 3

### Page 57

- saucer, pot, dish, pan
- socialist, party member, minister, communist
- operator, directory, dial, call box
- wound, injury, disease, fever
- gale, thunderstorm, lightning, frost
- pair, couple, billion, dozen

## Map Reading

### Page 58

- |                 |   |              |   |
|-----------------|---|--------------|---|
| 1. canal        |  | 7. forest    |  |
| 2. coast        |  | 8. footpath  |  |
| 3. bridge       |  | 9. old wall  |  |
| 4. farmland     |  | 10. motorway |  |
| 5. castle       |  | 11. village  |  |
| 6. stone circle |  | 12. ferry    |  |

## The Application Form

### Page 59

- Family name
- Mr/Mrs/Miss/Ms
- First name
- Date of birth
- Place of birth
- Marital status
- Children
- Present address
- Tel. no.
- Education: schools attended
- Education: university/college
- Previous experience
- Present position
- Present salary
- Languages spoken
- Driving licence
- Interests
- Names and addresses of 2 referees
- Date available
- Date
- Signature

## A Picnic in the Country

### Page 60

- Someone's reading.
- Someone's swimming.
- Someone's driving.
- Someone's climbing.
- Someone's drinking.
- Someone's riding.
- Someone's resting.
- Someone's fighting.
- Someone's jumping.
- Someone's sewing.
- Someone's crying.
- Someone's shaving.
- Someone's hurrying.
- Someone's laughing.
- Someone's hiding.
- Someone's standing.
- Someone's leaving.
- Someone's shooting.
- Someone's watching.
- Someone's running.

	True	False
1.	X	
2.		X
3.		X
4.	X	
5.		X
6.		X
7.	X	
8.	X	
9.	X	
10.	X	
11.	X	
12.		X
13.		X
14.		X
15.	X	
16.	X	
17.		X
18.		X
19.	X	
20.		X

## The Family Tree

### Page 51

1. Sidney is Steve's grandfather.
2. May is Steve's grandmother.
3. John is Steve's grandfather.
4. Alice is Steve's grandmother.
5. Ray is Steve's uncle.
6. Vera is Steve's aunt.
7. Alan is Steve's step-father.
8. Ruth is Steve's mother.
9. Roger is Steve's father.
10. Christopher is Steve's father-in-law.
11. Doris is Steve's mother-in-law.
12. Nancy is Steve's cousin.
13. Ann is Steve's sister-in-law.
14. Dave is Steve's brother.
15. Mary is Steve's first wife.
16. Pam is Steve's second wife.
17. Adam is Steve's nephew.
18. Irene is Steve's niece.
19. June is Steve's daughter-in-law.
20. Eric is Steve's son.
21. Joy is Steve's daughter.
22. Wendy is Steve's step-daughter.
23. Tracey is Steve's granddaughter.

## Words Ending in -TION

### Page 52

- |                  |                |
|------------------|----------------|
| 1. reservation   | 7. translation |
| 2. qualification | 8. operation   |
| 3. question      | 9. exhibition  |
| 4. competition   | 10. pollution  |
| 5. direction     | 11. population |
| 6. collection    | 12. revolution |

## The S Connection

### Page 53

trousers, scissors, shorts, tights, pyjamas, glasses, crossroads, news, customs, mathematics, stairs, clothes, jeans

## Collectives

### Page 54

- |              |                |
|--------------|----------------|
| 1. staff     | 9. bunch       |
| 2. flock     | 10. audience   |
| 3. class     | 11. queue      |
| 4. crowd     | 12. collection |
| 5. committee | 13. orchestra  |
| 6. club      | 14. team       |
| 7. jury      | 15. union      |
| 8. fleet     | 16. crew       |

## Complaints

### Page 55

- |                    |                     |
|--------------------|---------------------|
| 1. It's melted.    | 9. It's leaking.    |
| 2. It's broken.    | 10. It's torn.      |
| 3. It's dusty.     | 11. It's scratched. |
| 4. It's stretched. | 12. It's loose.     |
| 5. It's blunt.     | 13. It's cracked.   |
| 6. It's bad.       | 14. It's bent.      |
| 7. It's overripe.  | 15. It's slow.      |
| 8. It's dirty.     |                     |

## Language Functions

### Page 56

- |      |       |       |       |
|------|-------|-------|-------|
| 1. F | 6. E  | 11. D | 16. R |
| 2. C | 7. M  | 12. B | 17. Q |
| 3. N | 8. K  | 13. T | 18. J |
| 4. H | 9. L  | 14. S | 19. O |
| 5. I | 10. P | 15. A | 20. G |

## Proverbs

### Page 58

1. A stitch in time saves nine.
2. A bird in the hand is worth two in the bush.
3. An Englishman's home is his castle.
4. Many hands make light work.
5. Half a loaf is better than none/no bread.
6. One man's meat is another man's poison.
7. You can lead a horse to water but you cannot make him drink.
8. People in glass houses should not throw stones.

## Doubles 3

### Page 59

- |                   |                     |
|-------------------|---------------------|
| 1. charter flight | 7. boarding school  |
| 2. bypass         | 8. opera house      |
| 3. waterproof     | 9. notepaper        |
| 4. office worker  | 10. sightseeing     |
| 5. dishwasher     | 11. baby-sitter     |
| 6. toenails       | 12. native language |

# Answers

## OO and EE

### Page 6

**OO:** boot, wool, roof, cooker, root, balloon, pool, moon, scooter, door, floor

**EE:** queen, feet, tree, wheel, sheep, fifteen, sleeve, knee

## Masculine & Feminine

### Page 7

**Feminine:** 1. female 2. actress 3. aunt 4. cow  
5. stewardess 6. queen 7. heroine

**Masculine:** 8. lion 9. Englishman 10. master  
11. husband 12. waiter 13. nephew  
14. gentleman

## Clothes

### Page 8

- |                            |                       |
|----------------------------|-----------------------|
| 1. a large handkerchief    | 6. a silk tie         |
| 2. a plain T-shirt         | 7. a plastic belt     |
| 3. a patterned bra         | 8. a collarless shirt |
| 4. a short-sleeved sweater | 9. a dark suit        |
| 5. a child's raincoat      | 10. fur gloves        |

## Odd One Out I

### Page 9

- |           |            |
|-----------|------------|
| 1. listen | 4. beef    |
| 2. team   | 5. meaning |
| 3. string | 6. roof    |

## Money

### Page 10

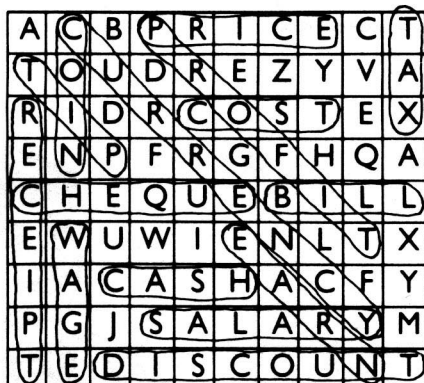

- |          |      |          |
|----------|------|----------|
| price    | tax  | salary   |
| cheque   | tip  | receipt  |
| cash     | earn | wage     |
| discount | cost | profit   |
| coin     | bill | currency |

## At the Theatre

### Page 11

- |                   |                 |
|-------------------|-----------------|
| 1. cloakroom      | 8. back seats   |
| 2. booking office | 9. row          |
| 3. bar            | 10. front seats |
| 4. entrance       | 11. orchestra   |
| 5. ladies         | 12. stage       |
| 6. gents          | 13. curtain     |
| 7. emergency exit |                 |

## What Would You Say?

### Page 12

- |                       |   |
|-----------------------|---|
| 1. What's the matter? | 8. Cheers.                              |
| 2. Sorry.             | 9. Mind out!                            |
| 3. How do you do?     | 10. What a surprise!                    |
| 4. Excuse me.         | 11. May I introduce you to Peter Brown. |
| 5. No thank you.      | 12. Cheerio.                            |
| 6. Good luck.         |   |
| 7. That's a pity.     |   |

## Abbreviations

### Page 13

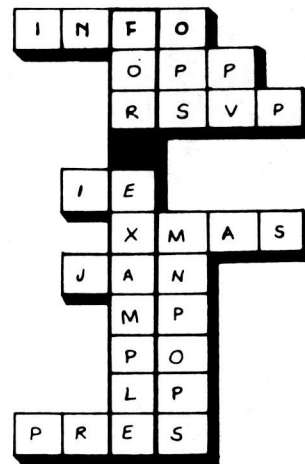

For Example = e.g.

## Emergency

### Page 14

- |                   |                  |
|-------------------|------------------|
| 1. A vet          | 5. F electrician |
| 2. E police       | 6. B dry cleaner |
| 3. H ambulance    | 7. D mechanic    |
| 4. C fire service | 8. G optician    |



## The Weather Forecast

Page 60

- frost
- shade
- sunshine
- mild
- gale
- icy
- freeze
- lightning
- heat
- overcast
- warm
- mist
- storm
- damp
- shower

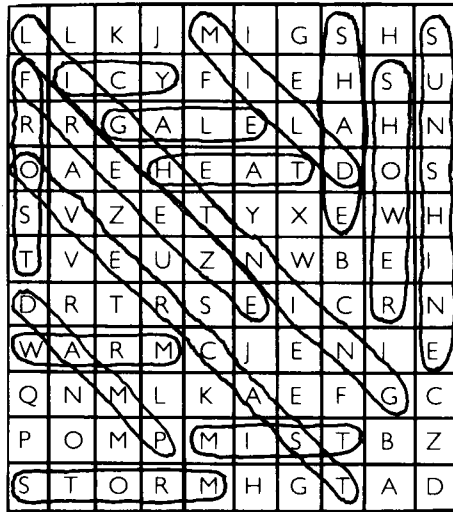

## Purchases

Page 61

### A Children's pool:

1. model
2. reference number
3. diameter (small size)
4. diameter (large size)
5. depth
6. material

### B Electric kettle:

7. capacity
8. consumption
9. voltage
10. cleaning
11. warning

### C Table tennis table:

12. dimensions
13. storage
14. accessories
15. guarantee
16. delivery

### D Sweater:

17. size
18. colour
19. composition
20. style
21. washing instructions

## Festivals and Feast Days

Page 62

1. a
2. a
3. a
4. d
5. c
6. b
7. d
8. c
9. b
10. c

## Body Talk

Page 63

- |                 |                 |
|-----------------|-----------------|
| 1. backbone     | 10. hairdresser |
| 2. backyard     | 11. hairbrush   |
| 3. backache     | 12. hairdryer   |
| 4. headmaster   | 13. handwriting |
| 5. headquarters | 14. handbag     |
| 6. headlines    | 15. handshake   |
| 7. footprints   | 16. eyelid      |
| 8. footsteps    | 17. eyelash     |
| 9. footpath     | 18. eyebrow     |

## Odd One Out 4

Page 64

- |           |          |
|-----------|----------|
| 1. bridge | 5. bee   |
| 2. meadow | 6. cliff |
| 3. gate   | 7. field |
| 4. hens   | 8. bush  |

## Verb Pieces

Page 65

- |                |            |
|----------------|------------|
| 1. come on     | 5. ring up |
| 2. put through | 6. hang on |
| 3. look after  | 7. fill in |
| 4. ask for     | 8. get in  |

## Words Beginning With CAR-

### Page 42

- |             |               |
|-------------|---------------|
| 1. caravan  | 7. carpenter  |
| 2. careful  | 8. caramel    |
| 3. carrot   | 9. cargo      |
| 4. cardigan | 10. card      |
| 5. cart     | 11. Caribbean |
| 6. carriage | 12. carpet    |

## Odd One Out 3

### Page 43

- |            |             |
|------------|-------------|
| 1. reduced | 5. sad      |
| 2. tiny    | 6. spotless |
| 3. ugly    | 7. bold     |
| 4. slow    | 8. sickly   |

## Make and Do

### Page 44

- |                     |                            |
|---------------------|----------------------------|
| 1. make progress    | 9. make trouble            |
| 2. make faces       | 10. make an effort         |
| 3. do the housework | 11. make a film            |
| 4. make a cake      | 12. do the shopping        |
| 5. do the gardening | 13. do business            |
| 6. make a choice    | 14. do the washing-up      |
| 7. make a speech    | 15. make a joke            |
| 8. make friends     | 16. do one's/your homework |

## Words and Meanings

### Page 45

- |           |            |
|-----------|------------|
| 1. book   | 12. change |
| 2. bank   | 13. box    |
| 3. leaf   | 14. plant  |
| 4. train  | 15. mark   |
| 5. note   | 16. record |
| 6. stick  | 17. post   |
| 7. park   | 18. saw    |
| 8. band   | 19. race   |
| 9. sink   | 20. hand   |
| 10. tap   | 21. jam    |
| 11. plane |            |

## The Wastepaper Basket

### Page 46

- |                        |                      |
|------------------------|----------------------|
| 1. a label             | 9. a guarantee       |
| 2. a cheque            | 10. a bill           |
| 3. an application form | 11. a memo           |
| 4. a telephone message | 12. an invitation    |
| 5. a letter            | 13. an advertisement |
| 6. a timetable         | 14. an order form    |
| 7. a ticket            | 15. a receipt        |
| 8. a telex             |                      |

## The Name Game

### Page 47

- |            |              |
|------------|--------------|
| 1. Stephen | 11. Patrick  |
| 2. Peter   | 12. Martin   |
| 3. Anthony | 13. Alison   |
| 4. James   | 14. Caroline |
| 5. Matthew | 15. Wendy    |
| 6. Philip  | 16. Rosemary |
| 7. Richard | 17. Rachel   |
| 8. Robert  | 18. Sandra   |
| 9. Harold  | 19. Janet    |
| 10. Ernest | 20. Janice   |

## Cross It Out

### Page 48

- |                          |                          |
|--------------------------|--------------------------|
| 1. windscreen, brake     | 9. ankle, chin           |
| 2. pink, purple          | 10. slides, prints       |
| 3. accountant, architect | 11. Socialism, Communism |
| 4. Catholicism, Judaism  | 12. honey, nuts          |
| 5. ring, coin            | 13. guitar, violin       |
| 6. Jupiter, Mars         | 14. shorts, scarf        |
| 7. Suez, Panama          | 15. doorway, ceiling     |
| 8. fees, rent            |                          |

The word left is **puzzle**.

## What's On The Menu

### Page 49

**Starters:** prawn cocktail, chilled melon, soup of the day, avocado pear

**Fish:** fresh Dover sole, fried plaice with parsley sauce, grilled mackerel, seafood pie

**Meat:** steak and kidney pie, roast beef and Yorkshire pudding, baked ham and pineapple, Madras chicken curry

**Vegetables:** brussels sprouts, new potatoes, plain boiled rice, creamed cauliflower

**Desserts:** lemon meringue pie, chocolate mousse, fruit salad with cream, cheesecake

**Drinks:** red house wine (by the glass), real English ale, fruit juices, minerals

## Connections

### Page 50

The 2 missing letters are:

- |       |          |        |        |
|-------|----------|--------|--------|
| 1. LE | 6. ER    | 11. DE | 16. SA |
| 2. CE | 7. CH    | 12. EF | 17. ST |
| 3. ME | 8. TE    | 13. AR | 18. AT |
| 4. OW | 9. NE/TE | 14. IN | 19. KE |
| 5. VE | 10. RE   | 15. SH | 20. AL |

## The Family Tree

### Page 51

1. Sidney is Steve's grandfather.
2. May is Steve's grandmother.
3. John is Steve's grandfather.
4. Alice is Steve's grandmother.
5. Ray is Steve's uncle.
6. Vera is Steve's aunt.
7. Alan is Steve's step-father.
8. Ruth is Steve's mother.
9. Roger is Steve's father.
10. Christopher is Steve's father-in-law.
11. Doris is Steve's mother-in-law.
12. Nancy is Steve's cousin.
13. Ann is Steve's sister-in-law.
14. Dave is Steve's brother.
15. Mary is Steve's first wife.
16. Pam is Steve's second wife.
17. Adam is Steve's nephew.
18. Irene is Steve's niece.
19. June is Steve's daughter-in-law.
20. Eric is Steve's son.
21. Joy is Steve's daughter.
22. Wendy is Steve's step-daughter.
23. Tracey is Steve's granddaughter.

## Words Ending in -TION

### Page 52

- |                  |                |
|------------------|----------------|
| 1. reservation   | 7. translation |
| 2. qualification | 8. operation   |
| 3. question      | 9. exhibition  |
| 4. competition   | 10. pollution  |
| 5. direction     | 11. population |
| 6. collection    | 12. revolution |

## The S Connection

### Page 53

trousers, scissors, shorts, tights, pyjamas, glasses, crossroads, news, customs, mathematics, stairs, clothes, jeans

## Collectives

### Page 54

- |              |                |
|--------------|----------------|
| 1. staff     | 9. bunch       |
| 2. flock     | 10. audience   |
| 3. class     | 11. queue      |
| 4. crowd     | 12. collection |
| 5. committee | 13. orchestra  |
| 6. club      | 14. team       |
| 7. jury      | 15. union      |
| 8. fleet     | 16. crew       |

## Complaints

### Page 55

- |                    |                     |
|--------------------|---------------------|
| 1. It's melted.    | 9. It's leaking.    |
| 2. It's broken.    | 10. It's torn.      |
| 3. It's dusty.     | 11. It's scratched. |
| 4. It's stretched. | 12. It's loose.     |
| 5. It's blunt.     | 13. It's cracked.   |
| 6. It's bad.       | 14. It's bent.      |
| 7. It's overripe.  | 15. It's slow.      |
| 8. It's dirty.     |                     |

## Language Functions

### Page 56

- |      |       |       |       |
|------|-------|-------|-------|
| 1. F | 6. E  | 11. D | 16. R |
| 2. C | 7. M  | 12. B | 17. Q |
| 3. N | 8. K  | 13. T | 18. J |
| 4. H | 9. L  | 14. S | 19. O |
| 5. I | 10. P | 15. A | 20. G |

## Proverbs

### Page 58

1. A stitch in time saves nine.
2. A bird in the hand is worth two in the bush.
3. An Englishman's home is his castle.
4. Many hands make light work.
5. Half a loaf is better than none/no bread.
6. One man's meat is another man's poison.
7. You can lead a horse to water but you cannot make him drink.
8. People in glass houses should not throw stones.

## Doubles 3

### Page 59

- |                   |                     |
|-------------------|---------------------|
| 1. charter flight | 7. boarding school  |
| 2. bypass         | 8. opera house      |
| 3. waterproof     | 9. notepaper        |
| 4. office worker  | 10. sightseeing     |
| 5. dishwasher     | 11. baby-sitter     |
| 6. toenails       | 12. native language |

# Answers

## OO and EE

### Page 6

**OO:** boot, wool, roof, cooker, root, balloon, pool, moon, scooter, door, floor

**EE:** queen, feet, tree, wheel, sheep, fifteen, sleeve, knee

## Masculine & Feminine

### Page 7

**Feminine:** 1. female 2. actress 3. aunt 4. cow  
5. stewardess 6. queen 7. heroine

**Masculine:** 8. lion 9. Englishman 10. master  
11. husband 12. waiter 13. nephew  
14. gentleman

## Clothes

### Page 8

- |                            |                       |
|----------------------------|-----------------------|
| 1. a large handkerchief    | 6. a silk tie         |
| 2. a plain T-shirt         | 7. a plastic belt     |
| 3. a patterned bra         | 8. a collarless shirt |
| 4. a short-sleeved sweater | 9. a dark suit        |
| 5. a child's raincoat      | 10. fur gloves        |

## Odd One Out I

### Page 9

- |           |            |
|-----------|------------|
| 1. listen | 4. beef    |
| 2. team   | 5. meaning |
| 3. string | 6. roof    |

## Money

### Page 10

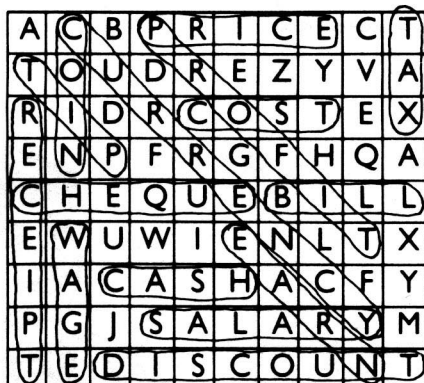

- |          |      |          |
|----------|------|----------|
| price    | tax  | salary   |
| cheque   | tip  | receipt  |
| cash     | earn | wage     |
| discount | cost | profit   |
| coin     | bill | currency |

## At the Theatre

### Page 11

- |                   |                 |
|-------------------|-----------------|
| 1. cloakroom      | 8. back seats   |
| 2. booking office | 9. row          |
| 3. bar            | 10. front seats |
| 4. entrance       | 11. orchestra   |
| 5. ladies         | 12. stage       |
| 6. gents          | 13. curtain     |
| 7. emergency exit |                 |

## What Would You Say?

### Page 12

- |                       |   |
|-----------------------|---|
| 1. What's the matter? | 8. Cheers.                              |
| 2. Sorry.             | 9. Mind out!                            |
| 3. How do you do?     | 10. What a surprise!                    |
| 4. Excuse me.         | 11. May I introduce you to Peter Brown. |
| 5. No thank you.      | 12. Cheerio.                            |
| 6. Good luck.         |   |
| 7. That's a pity.     |   |

## Abbreviations

### Page 13

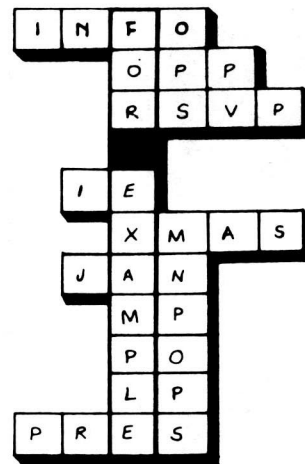

For Example = e.g.

## Emergency

### Page 14

- |                   |                  |
|-------------------|------------------|
| 1. A vet          | 5. F electrician |
| 2. E police       | 6. B dry cleaner |
| 3. H ambulance    | 7. D mechanic    |
| 4. C fire service | 8. G optician    |

## The Weather Forecast

Page 60

frost  
shade  
sunshine  
mild  
gale  
icy  
freeze  
lightning  
heat  
overcast  
warm  
mist  
storm  
damp  
shower

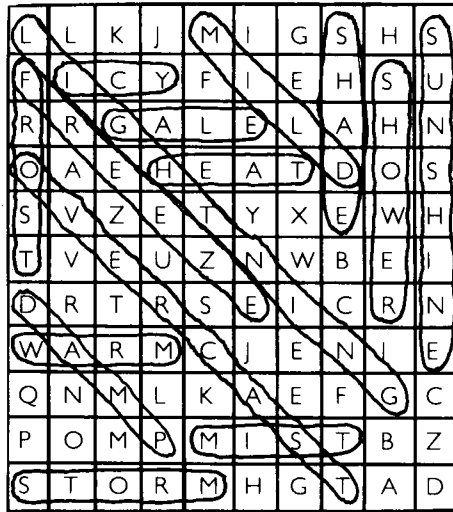

## Purchases

Page 61

### A Children's pool:

1. model 2. reference number 3. diameter (small size) 4. diameter (large size) 5. depth 6. material

### B Electric kettle:

7. capacity 8. consumption 9. voltage 10. cleaning 11. warning

### C Table tennis table:

12. dimensions 13. storage 14. accessories 15. guarantee 16. delivery

### D Sweater:

17. size 18. colour 19. composition 20. style 21. washing instructions

## Festivals and Feast Days

Page 62

1. a 2. a 3. a 4. d 5. c 6. b 7. d 8. c 9. b 10. c

## Body Talk

Page 63

- |                 |                 |
|-----------------|-----------------|
| 1. backbone     | 10. hairdresser |
| 2. backyard     | 11. hairbrush   |
| 3. backache     | 12. hairdryer   |
| 4. headmaster   | 13. handwriting |
| 5. headquarters | 14. handbag     |
| 6. headlines    | 15. handshake   |
| 7. footprints   | 16. eyelid      |
| 8. footsteps    | 17. eyelash     |
| 9. footpath     | 18. eyebrow     |

## Odd One Out 4

Page 64

- |           |          |
|-----------|----------|
| 1. bridge | 5. bee   |
| 2. meadow | 6. cliff |
| 3. gate   | 7. field |
| 4. hens   | 8. bush  |

## Verb Pieces

Page 65

- |                |            |
|----------------|------------|
| 1. come on     | 5. ring up |
| 2. put through | 6. hang on |
| 3. look after  | 7. fill in |
| 4. ask for     | 8. get in  |

# Answers

## What's It For?

### Page 6

1. A towel is for drying.
2. An iron is for pressing.
3. Glue is for sticking.
4. A kettle is for boiling.
5. A tin-opener/can-opener is for opening.
6. A razor is for shaving.
7. A spoon is for stirring.
8. An oven is for baking.
9. A ruler is for measuring.
10. A spade is for digging.
11. A ladder is for climbing.
12. A needle is for sewing.

## GB and the US

### Page 7

The English word is placed in front of the American English equivalent

- |                       |                       |
|-----------------------|-----------------------|
| 1. trousers/pants     | 9. lavatory/restroom  |
| 2. return/roundtrip   | 10. cinema/movies     |
| 3. lift/elevator      | 11. sweets/candy      |
| 4. holiday/vacation   | 12. pavement/sidewalk |
| 5. autumn/fall        | 13. biscuit/cookie    |
| 6. chips/French fries | 14. car/automobile    |
| 7. tube/subway        | 15. taxi/cab          |
| 8. petrol/gas         |                       |

## Prepositions

### Page 8

- |                 |                 |
|-----------------|-----------------|
| 1. by oneself   | 7. on holiday   |
| 2. on fire      | 8. out of reach |
| 3. by train     | 9. out of date  |
| 4. on business  | 10. out of work |
| 5. out of doors | 11. by air      |
| 6. by heart     | 12. on sale     |

## Crime and Punishment

### Page 9

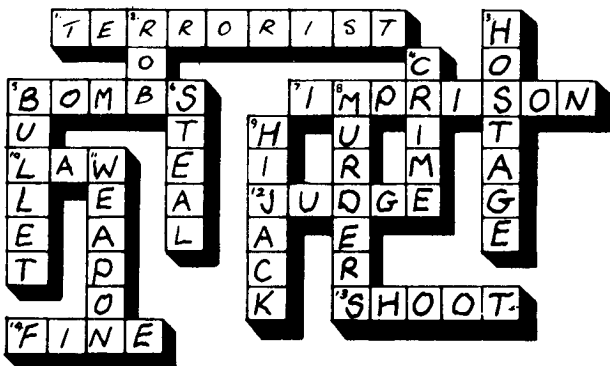

## The Living World

### Page 10

- |           |           |            |
|-----------|-----------|------------|
| 1. rat    | 6. deer   | 11. mouse  |
| 2. parrot | 7. rabbit | 12. goat   |
| 3. lion   | 8. camel  | 13. donkey |
| 4. bear   | 9. snake  |            |
| 5. tiger  | 10. pig   |            |

## Sort Them Out I

### Page 11

**Verb and Noun:** tour, remark, photograph, phone, escape, smile, drop, plan, copy, journey, delay, match, land, guide, quarrel, dress, guess

**Verb:** eat, arrive, learn, deliver, marry, speak, follow, satisfy, collect, teach, lend, entertain, remember

**Noun:** path, luck, peace, tent, opinion, middle, crime, enemy, danger, planet

## As . . . as . . .

### Page 12

- |                           |                          |
|---------------------------|--------------------------|
| 1. As dry as dust         | 6. As brave as a lion    |
| 2. As hard as a rock      | 7. As light as a feather |
| 3. As pretty as a picture | 8. As black as coal      |
| 4. As hot as hell         | 9. As quiet as a mouse   |
| 5. As cold as ice         | 10. As sick as a dog     |

## Pairs

### Page 13

- |                       |                   |
|-----------------------|-------------------|
| ladies and gentlemen  | bed and breakfast |
| far and wide          | here and now      |
| neat and tidy         | bits and pieces   |
| rules and regulations | dead and buried   |
| head and shoulders    | fish and chips    |
| flesh and blood       | bread and butter  |
| body and soul         | facts and figures |
| knife and fork        | sick and tired    |
| men and women         |                   |

## Cross It Out

### Page 14

- |                                 |                            |
|---------------------------------|----------------------------|
| 1. hay, lightning, lemon, straw | 6. cabbage, pea            |
| 2. blood, bricks, fire          | 7. tongue                  |
| 3. nuts, mud, tobacco           | 8. coal                    |
| 4. ash, elephant                | 9. sky                     |
| 5. chalk, snowstorm             | 10. glass, gas, air, water |
|                                 | 11. rainbow                |

The word that is left is **carrot** and it is **orange**.

## Mind and Body

### Page 56

A = 1 B = 11 C = 5 D = 20 E = 17 F = 3  
 G = 9 H = 8 I = 6 J = 14 K = 18 L = 4  
 M = 19 N = 12 O = 13 P = 7 Q = 16  
 R = 15 S = 10 T = 2

## Sayings

### Page 58

- 1 + 7 = D Every cloud has a silver lining  
 2 + 5 = C One swallow does not make a summer  
 3 + 8 = A It's no use crying over spilt milk  
 4 + 6 = B Don't look a gift horse in the mouth

## Wordboard 2

### Page 59

- |                |                     |
|----------------|---------------------|
| 1. MAIL        | 8. WAIST            |
| MALE           | WASTE               |
| MAN OR BOY     | REFUSE              |
| 2. COURT       | 9. SAIL             |
| CAUGHT         | SALE                |
| CAPTURED       | GOODS AT LOW PRICES |
| 3. SAW         | 10. ROOTS           |
| SORE           | ROUTES              |
| HURTING        | ROADS               |
| 4. STATIONERY  | 11. BOARD           |
| STATIONARY     | BORED               |
| NOT MOVING     | FED UP              |
| 5. PEAR        | 12. DEER            |
| PAIR           | DEAR                |
| TWO            | EXPENSIVE           |
| 6. SCENT       |                     |
| CENT           |                     |
| AMERICAN MONEY |                     |
| 7. MINER       |                     |
| MINOR          |                     |
| UNIMPORTANT    |                     |

## The Travel Brochure

### Page 60

#### THE IMPERIAL HOTEL

(1) *Situated* only five minutes from the Floral Square, (2) *close to* the waterfront of the River Bari, a (3) *luxury* hotel with all (4) *facilities* including a (5) *spectacular* ballroom used for all the important functions of the town. Patio gardens, rooftop restaurant serving (6) *traditional* dishes. Large (7) *well run* bar, popular with the locals and residents makes a (8) *friendly* atmosphere in (9) *comfortable* surroundings.

#### THE CONTINENTAL HOTEL

Everything has been thought of to make your stay (9) *comfortable*. All bedrooms have private (4) *facilities* and look out onto a (6) *traditional* courtyard. (1) *Situated* a few steps from the east canal, this hotel enjoys (5) *spectacular* views of the port and out to

sea. The residents can enjoy, completely free of charge, the (3) *luxury* Island Club (2) *close to* the hotel, which consists of a bar and ballroom. The (8) *well run* gamesroom is supervised by (9) *friendly* and efficient staff.

### Cirali

The distinctive (1) *features* of Cirali are its much valued historical, architectural and artistic treasures. Built around a steep hill (2) *surrounded by* undulating valleys, Cirali occupies a (3) *remarkable* position in the heart of the countryside. The (4) *range* of monuments to be seen is impressive – much is (5) *preserved* of all the ages, a true history book of the past (6) *linked to* our present civilisation. Modern (7) *development* has not interfered with the ancient town of steep streets and (8) *alleyways*, just as the (9) *vineyards* have not interfered with the fields of wheat.

### Lasyp

Lasyp is a (3) *remarkable* medieval town untouched by recent (7) *developments*. (2) *Surrounded by* rocky mountains it is sometimes called 'The City of Silence'. The narrow, picturesque streets are (6) *linked by* winding (8) *alleyways*. The town hall, with its well (5) *preserved* tablets giving information about certain (1) *features* of the old legal system is well worth a visit and from its bell-tower unfolds a (4) *range of* magnificent views, from (9) *vineyards* to ancient ruins.

## Glidogram 2

### Page 62

- |                        |                |
|------------------------|----------------|
| 1. establish           | 13. ideal      |
| 2. estimate            | 14. festival   |
| 3. estate              | 15. occasional |
| 4. western             | 16. final      |
| 5. questionnaire       | 17. signal     |
| 6. digestion/intestine | 18. dealer     |
| 7. investigation       | 19. invalid    |
| 8. protest             | 20. false      |
| 9. harvest             | 21. equality   |
| 10. guest              | 22. alarm      |
| 11. interest           | 23. album      |
| 12. contest            | 24. alphabet   |

## Verb Gymnastics

### Page 63

- |          |           |             |
|----------|-----------|-------------|
| 1. lose  | 6. pass   | 11. make up |
| 2. go on | 7. change | 12. deliver |
| 3. make  | 8. grow   | 13. put on  |
| 4. do    | 9. pay    | 14. run     |
| 5. save  | 10. play  | 15. set     |

## Train of Thought

### Page 64

1. c 2. c 3. a 4. b 5. d 6. d 7. b 8. c 9. d  
 10. b 11. b 12. c 13. d 14. c

# Answers

## What's It For?

### Page 6

1. A towel is for drying.
2. An iron is for pressing.
3. Glue is for sticking.
4. A kettle is for boiling.
5. A tin-opener/can-opener is for opening.
6. A razor is for shaving.
7. A spoon is for stirring.
8. An oven is for baking.
9. A ruler is for measuring.
10. A spade is for digging.
11. A ladder is for climbing.
12. A needle is for sewing.

## GB and the US

### Page 7

The English word is placed in front of the American English equivalent

- |                       |                       |
|-----------------------|-----------------------|
| 1. trousers/pants     | 9. lavatory/restroom  |
| 2. return/roundtrip   | 10. cinema/movies     |
| 3. lift/elevator      | 11. sweets/candy      |
| 4. holiday/vacation   | 12. pavement/sidewalk |
| 5. autumn/fall        | 13. biscuit/cookie    |
| 6. chips/French fries | 14. car/automobile    |
| 7. tube/subway        | 15. taxi/cab          |
| 8. petrol/gas         |                       |

## Prepositions

### Page 8

- |                 |                 |
|-----------------|-----------------|
| 1. by oneself   | 7. on holiday   |
| 2. on fire      | 8. out of reach |
| 3. by train     | 9. out of date  |
| 4. on business  | 10. out of work |
| 5. out of doors | 11. by air      |
| 6. by heart     | 12. on sale     |

## Crime and Punishment

### Page 9

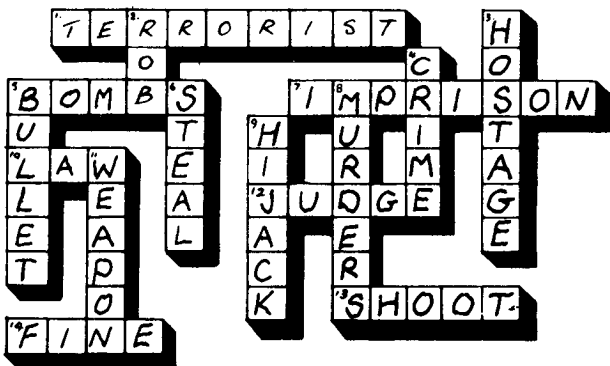

## The Living World

### Page 10

- |           |           |            |
|-----------|-----------|------------|
| 1. rat    | 6. deer   | 11. mouse  |
| 2. parrot | 7. rabbit | 12. goat   |
| 3. lion   | 8. camel  | 13. donkey |
| 4. bear   | 9. snake  |            |
| 5. tiger  | 10. pig   |            |

## Sort Them Out I

### Page 11

**Verb and Noun:** tour, remark, photograph, phone, escape, smile, drop, plan, copy, journey, delay, match, land, guide, quarrel, dress, guess

**Verb:** eat, arrive, learn, deliver, marry, speak, follow, satisfy, collect, teach, lend, entertain, remember

**Noun:** path, luck, peace, tent, opinion, middle, crime, enemy, danger, planet

## As . . . as . . .

### Page 12

- |                           |                          |
|---------------------------|--------------------------|
| 1. As dry as dust         | 6. As brave as a lion    |
| 2. As hard as a rock      | 7. As light as a feather |
| 3. As pretty as a picture | 8. As black as coal      |
| 4. As hot as hell         | 9. As quiet as a mouse   |
| 5. As cold as ice         | 10. As sick as a dog     |

## Pairs

### Page 13

- |                       |                   |
|-----------------------|-------------------|
| ladies and gentlemen  | bed and breakfast |
| far and wide          | here and now      |
| neat and tidy         | bits and pieces   |
| rules and regulations | dead and buried   |
| head and shoulders    | fish and chips    |
| flesh and blood       | bread and butter  |
| body and soul         | facts and figures |
| knife and fork        | sick and tired    |
| men and women         |                   |

## Cross It Out

### Page 14

- |                                 |                            |
|---------------------------------|----------------------------|
| 1. hay, lightning, lemon, straw | 6. cabbage, pea            |
| 2. blood, bricks, fire          | 7. tongue                  |
| 3. nuts, mud, tobacco           | 8. coal                    |
| 4. ash, elephant                | 9. sky                     |
| 5. chalk, snowstorm             | 10. glass, gas, air, water |
|                                 | 11. rainbow                |

The word that is left is **carrot** and it is **orange**.



## Headlines

### Page 15

- |                   |                 |
|-------------------|-----------------|
| 1. break down = a | 6. picks = a    |
| 2. urges = c      | 7. struggle = b |
| 3. over = a       | 8. give up = d  |
| 4. affects = c    | 9. fans = b     |
| 5. solution = d   | 10. chance = c  |

## Statistics

### Page 16

- |  |                      |
|--|----------------------|
| 1. Males                                 | 13. Average rainfall |
| 2. Females                               | 14. Prevailing winds |
| 3. Average number of children per family | 15. Surface area     |
| 4. Life expectancy                       | 16. Relief           |
| 5. Official languages                    | 17. Flora            |
| 6. Religion                              | 18. Fauna            |
| 7. Government                            | 19. Highest mountain |
| 8. Currency                              | 20. River            |
| 9. Armed services                        | 21. Mineral deposits |
| 10. Capital city                         | 22. Industry         |
| 11. Average temperature (winter)         | 23. Main exports     |
| 12. Average temperature (summer)         | 24. Agriculture      |
|  | 25. Fishing          |
|  | 26. Airport          |
|  | 27. Ferry            |

## Prefixes and Suffixes

### Page 17

- |                              |                     |
|------------------------------|---------------------|
| 1. friendship/friendly       | 8. undo             |
| 2. goodness                  | 9. transform        |
| 3. tallish                   | 10. popularity      |
| 4. international/nationality | 11. mid-July        |
| 5. superman                  | 12. motherhood      |
| 6. cigarette                 | 13. misbehave       |
| 7. overtime                  | 14. kindly/kindness |

## Links

### Page 18

1. d 2. a 3. d 4. c 5. b 6. c 7. b 8. a 9. c 10. d

## Rainbow

### Page 19

- rain: rainbow, raincoat, rainfall
- sun: sunrise, sunset, sunshine, Sunday, sunlight
- house: housewife, household, housework, housekeeper
- air: aircraft, airline, airmail, airport
- bed: bedclothes, bedside, bedroom, bedsitter
- tooth: toothpaste, toothache, toothbrush
- table: tablecloth, table tennis

## Verb Pieces

### Page 20

- |               |               |             |
|---------------|---------------|-------------|
| 1. hand out   | 4. write down | 7. look for |
| 2. call for   | 5. give back  | 8. get off  |
| 3. break down | 6. throw away |             |

## Politics

### Page 21

- government  
monarch  
elections  
Socialist  
parliament  
state  
vote  
minister  
Communist  
democracy  
Conservative  
Liberal  
republic  
party  
leader

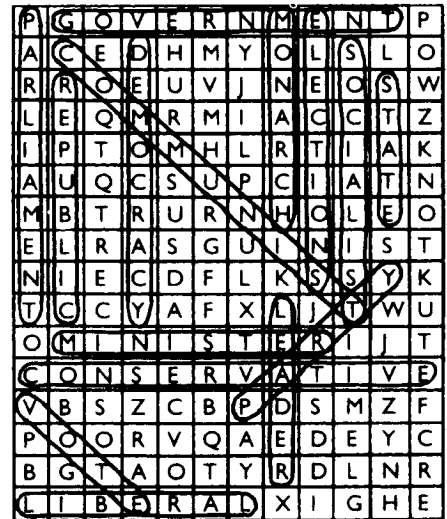

## Sort Them Out 2

### Page 22

**Adverb and adjective:** early, daily, only, monthly, weekly, yearly

**Adverb:** lately, happily, highly, badly, unfortunately, slightly, merely, nearly, really, actually, hardly, fairly

**Adjective:** lovely, lively, friendly, curly, ugly, silly, unlikely

## Get Well Soon

### Page 23

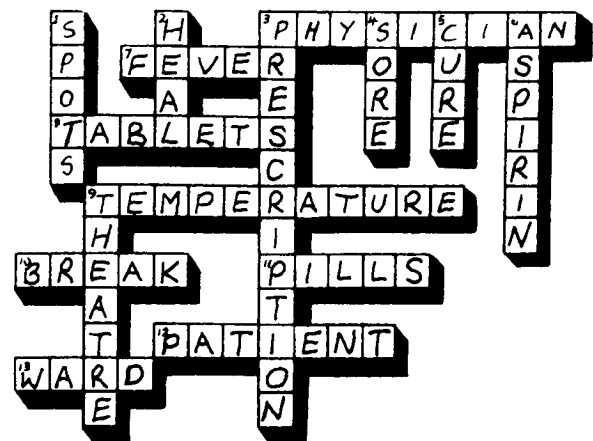

## Headlines

### Page 15

- |                   |                 |
|-------------------|-----------------|
| 1. break down = a | 6. picks = a    |
| 2. urges = c      | 7. struggle = b |
| 3. over = a       | 8. give up = d  |
| 4. affects = c    | 9. fans = b     |
| 5. solution = d   | 10. chance = c  |

## Statistics

### Page 16

- |  |                      |
|--|----------------------|
| 1. Males                                 | 13. Average rainfall |
| 2. Females                               | 14. Prevailing winds |
| 3. Average number of children per family | 15. Surface area     |
| 4. Life expectancy                       | 16. Relief           |
| 5. Official languages                    | 17. Flora            |
| 6. Religion                              | 18. Fauna            |
| 7. Government                            | 19. Highest mountain |
| 8. Currency                              | 20. River            |
| 9. Armed services                        | 21. Mineral deposits |
| 10. Capital city                         | 22. Industry         |
| 11. Average temperature (winter)         | 23. Main exports     |
| 12. Average temperature (summer)         | 24. Agriculture      |
|  | 25. Fishing          |
|  | 26. Airport          |
|  | 27. Ferry            |

## Prefixes and Suffixes

### Page 17

- |                              |                     |
|------------------------------|---------------------|
| 1. friendship/friendly       | 8. undo             |
| 2. goodness                  | 9. transform        |
| 3. tallish                   | 10. popularity      |
| 4. international/nationality | 11. mid-July        |
| 5. superman                  | 12. motherhood      |
| 6. cigarette                 | 13. misbehave       |
| 7. overtime                  | 14. kindly/kindness |

## Links

### Page 18

1. d 2. a 3. d 4. c 5. b 6. c 7. b 8. a 9. c 10. d

## Rainbow

### Page 19

- rain: rainbow, raincoat, rainfall
- sun: sunrise, sunset, sunshine, Sunday, sunlight
- house: housewife, household, housework, housekeeper
- air: aircraft, airline, airmail, airport
- bed: bedclothes, bedside, bedroom, bedsitter
- tooth: toothpaste, toothache, toothbrush
- table: tablecloth, table tennis

## Verb Pieces

### Page 20

- |               |               |             |
|---------------|---------------|-------------|
| 1. hand out   | 4. write down | 7. look for |
| 2. call for   | 5. give back  | 8. get off  |
| 3. break down | 6. throw away |             |

## Politics

### Page 21

- government  
monarch  
elections  
Socialist  
parliament  
state  
vote  
minister  
Communist  
democracy  
Conservative  
Liberal  
republic  
party  
leader

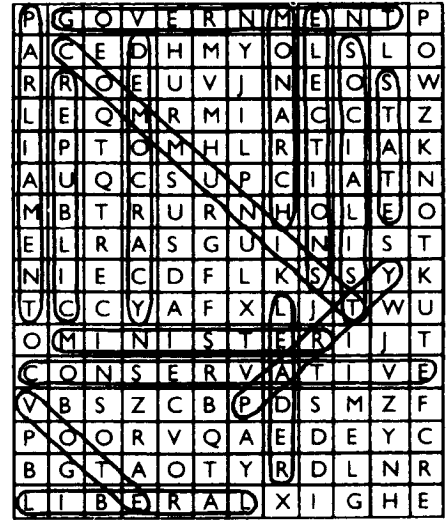

## Sort Them Out 2

### Page 22

**Adverb and adjective:** early, daily, only, monthly, weekly, yearly

**Adverb:** lately, happily, highly, badly, unfortunately, slightly, merely, nearly, really, actually, hardly, fairly

**Adjective:** lovely, lively, friendly, curly, ugly, silly, unlikely

## Get Well Soon

### Page 23

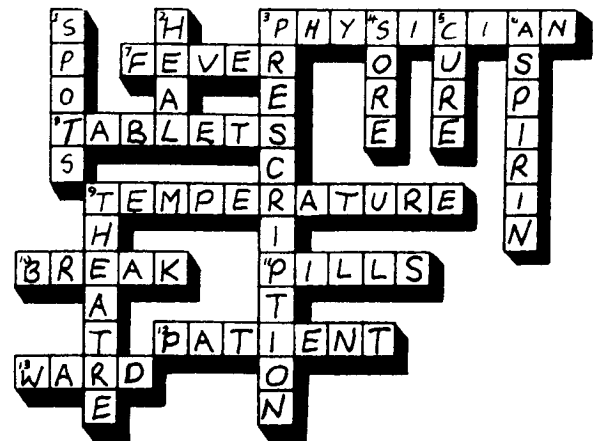

## Food For Thought

### Page 24

- |          |                    |          |
|----------|--------------------|----------|
| 1. bread | 4. coffee          | 7. wine  |
| 2. meat  | 5. fish            | 8. fruit |
| 3. sauce | 6. vegetable curry |          |
- A strong, milky, sweet, refreshing, weak, iced  
 B hard, strong, ripe, mild, tasty, crumbly  
 C still, fizzy, sweet, sparkling, refreshing, iced

## Four Of A Kind

### Page 25

- |            |            |            |
|------------|------------|------------|
| 1. box     | 8. glasses | 15. book   |
| 2. house   | 9. room    | 16. party  |
| 3. machine | 10. bag    | 17. name   |
| 4. car     | 11. coat   | 18. table  |
| 5. board   | 12. pot    | 19. end    |
| 6. paper   | 13. line   | 20. course |
| 7. card    | 14. horse  |            |

## Word Perfect

### Page 26

- |                  |                |
|------------------|----------------|
| 1. appointment   | 11. angle      |
| 2. loose         | 12. sensitive  |
| 3. advertisement | 13. melt       |
| 4. row           | 14. economical |
| 5. souvenir      | 15. clothes    |
| 6. employee      | 16. quiet      |
| 7. take          | 17. warning    |
| 8. information   | 18. lose       |
| 9. interval      | 19. win        |
| 10. earn         | 20. angel      |

## Leisure and Pleasure

### Page 27

- |             |          |           |              |
|-------------|----------|-----------|--------------|
| 1. knitting | 4. darts | 7. drama  | 10. fashion  |
| 2. antiques | 5. chess | 8. models | 11. cookery  |
| 3. pottery  | 6. pets  | 9. bridge | 12. aerobics |

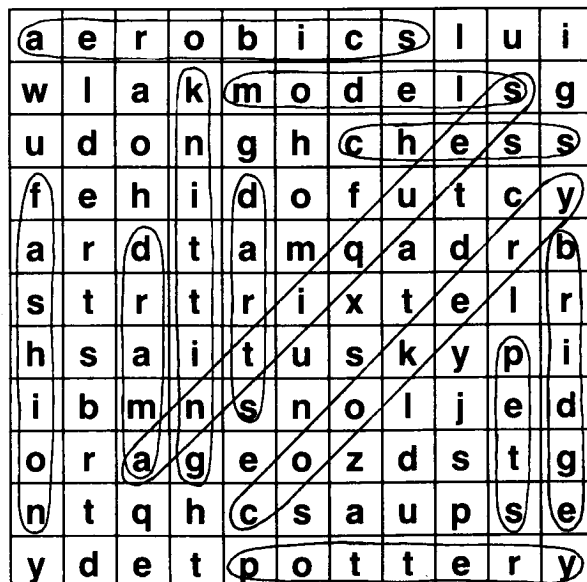

## What's on TV Tonight?

### Page 28

- |                              |                         |
|------------------------------|-------------------------|
| 1. news                      | 7. educational          |
| 2. panel game                | 8. sports               |
| 3. music                     | 9. cartoons             |
| 4. party political broadcast | 10. documentary         |
| 5. variety show              | 11. quiz show           |
| 6. late night thriller       | 12. religious broadcast |

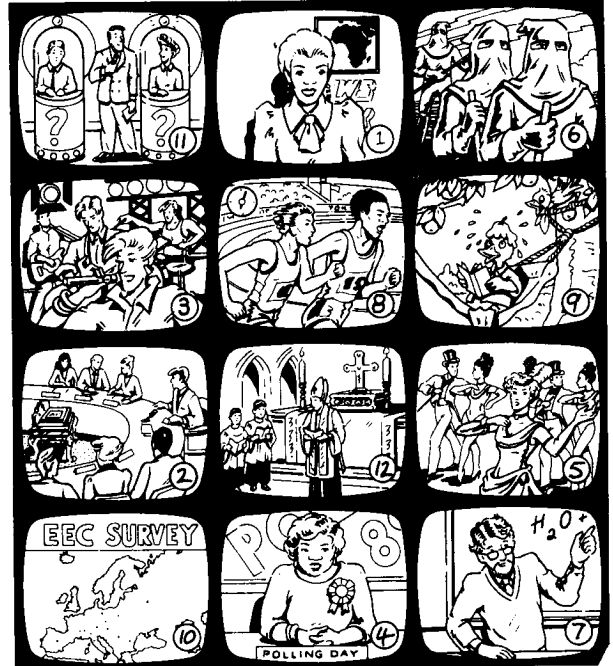

- people who appear on the screen; announcer, interviewer, newscaster, presenter, commentator
- people who work behind the scenes: cameraman, director, designer, producer
- parts of a television: serial, buttons, plug
- slang words for television: telly, the box
- word for those who watch: viewers

## Treasure Hunt

### Page 30

1. G 2. O 3. L 4. D 5. A 6. N 7. D 8. D  
 9. I 10. A 11. M 12. O 13. N 14. D 15. S  
 The treasure is in *Square T* (in the nest)  
 The treasure is **GOLD AND DIAMONDS**

## Dominoes I

### Page 31

- |                  |                   |
|------------------|-------------------|
| 1. deep freeze   | 10. cupboard      |
| 2. carving knife | 11. nutcracker    |
| 3. dishwasher    | 12. tin-opener    |
| 4. microwave     | 13. tablespoon    |
| 5. teatowel      | 14. corkscrew     |
| 6. saucepan      | 15. teaspoon      |
| 7. bottle-opener | 16. potato-peeler |
| 8. napkin        | 17. frying-pan    |
| 9. tablecloth    |                   |

**2**

**English  
Puzzles**

# ENGLISH PUZZLES

1, 2, 3

WITH ANSWERS



# CONTENTS

## PART 1

1. Coloured Pens
2. Film Titles
3. Shopping Accident
4. American Football
5. Find the Words
6. Wind Damage
7. Crossword Pieces
8. Male and Female
9. Add a Letter
10. Names
11. Theatre Posters
12. Do It Yourself
13. At the Cinema
14. A Different Alphabet
15. Countries In Code
16. At Home
17. Book Titles
18. Verb Crossword
19. Add Two Letters
20. TV Programmes
21. Jobs
22. Song Titles
23. Badges
24. Verb Backgammon
25. Fruit
26. Mistakes On The Signpost
27. Pounds And Pence
28. Olympic Rings
29. ANSWERS 1

## PART 2

1. Top Half Only
2. Well Played
3. People and Things
4. What's on the menu
5. Strange Pictures
6. Letters Into Words
7. Beatles Crossword
8. Rhyming Pairs
9. Words and Pictures
10. Famous Names

11. Take Them Away
12. From Time To Time
13. Find the Families
14. Which Medicine
15. Song Titles
16. A Chemical Code
17. Bottom Half Only
18. Crossword in 2 Parts
19. Road Signs
20. Eye Test
21. Holiday Photos
22. Saying The Wrong Thing
23. Heavy Syllables
24. What Are Their Jobs
25. Complete The Titles
26. ANSWERS 2

## PART 3

1. Doctor
2. Absurd Riddles
3. Crossword in 2 Halves (Past Simple and Past Participle)
4. Silent Letters
5. Imaginary and Real Jobs
6. Pairs of Words
7. Abbreviations Crossword
8. A Strange Quiz
9. A Very Official Jigsaw
10. Grammar Files
11. Documents For the Files
12. Strong Feelings
13. Telegram Language
14. Logical Laws
15. At the Theatre(2)
16. Disk Jockey
17. Numberplates (car part crossword)
18. House And Garden
19. What Do They Really Mean
20. Interesting Facts
21. ANSWERS 3

# ENGLISH PUZZLES-1

# Coloured pens



In your imagination, pick up these pens one by one – taking the top one each time.

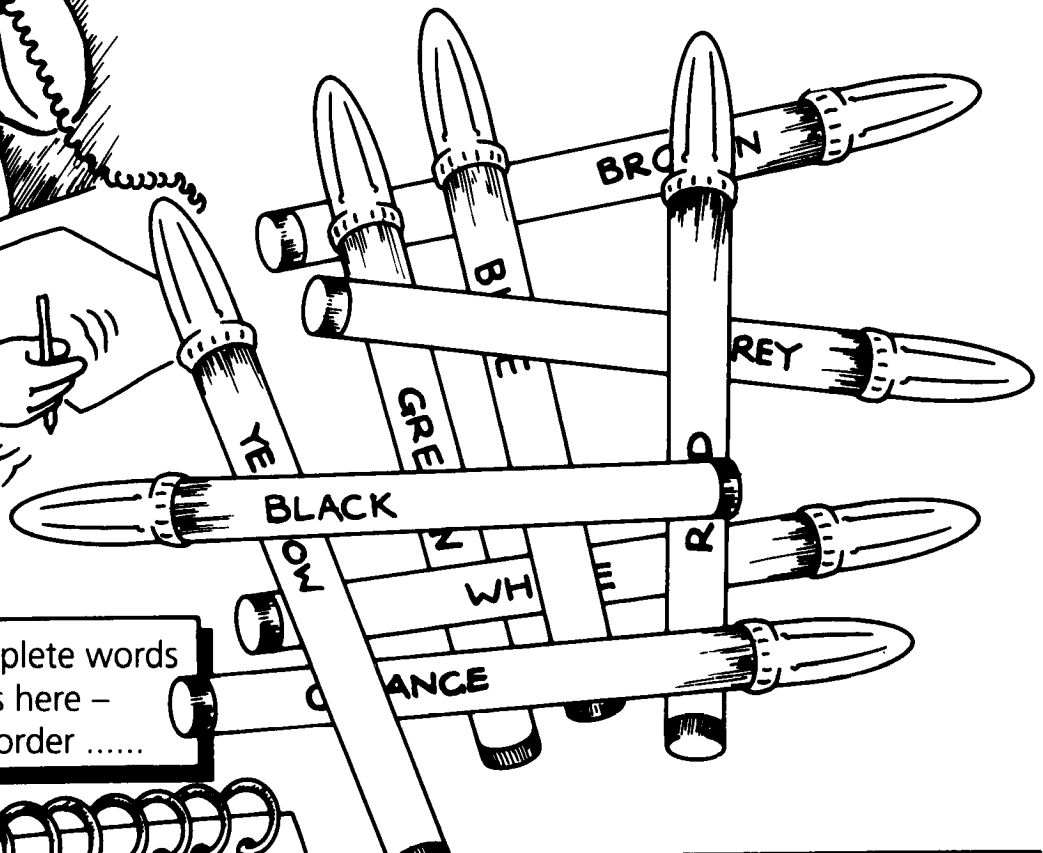

Write the complete words for the colours here – in the correct order .....

1	BLACK
2	
3	
4	
5	
6	
7	
8	
9	

... and then put the words into the grid.

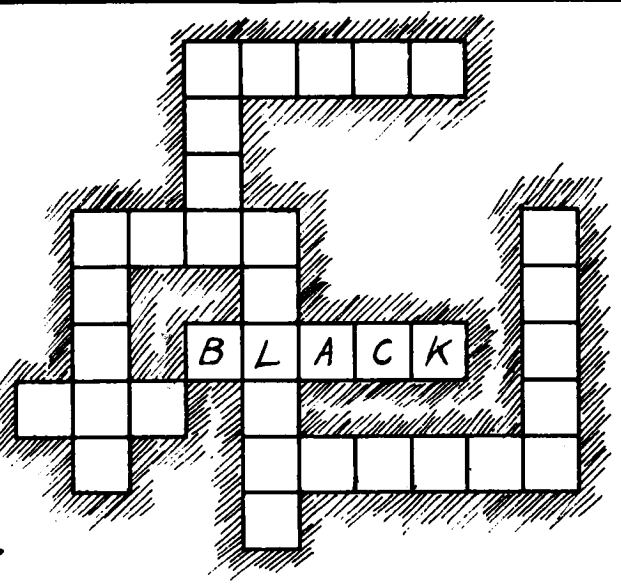



# Film Titles

Read the film titles and write them on the correct posters.  
(The films are from the United Kingdom, the United States, France and Italy.)

Two People  
(US, 1973)

Two Women  
(IT/FR, 1960)

Three Men In A Boat  
(UK, 1956)

Three Men On A Horse  
(US, 1936)

Seven Women  
(US, 1966)

Seven Angry Men  
(US, 1954)

Ten Tall Men  
(US, 1951)

Twelve Angry Men  
(US, 1957)

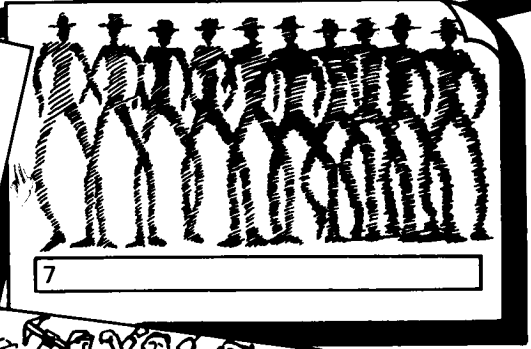
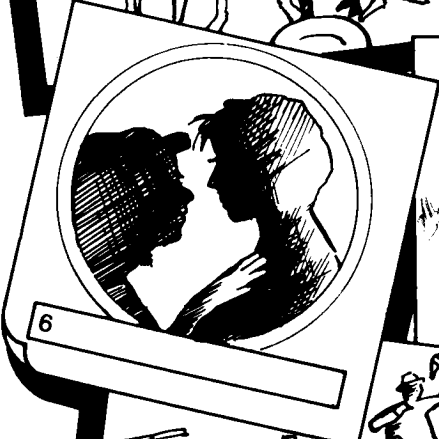
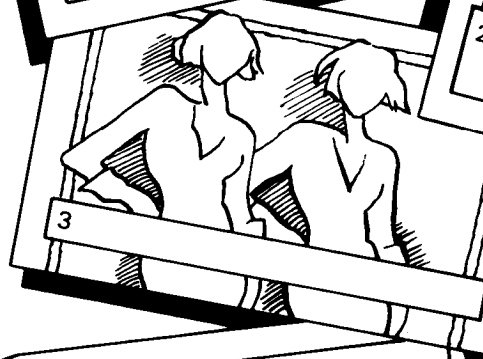

# SHOPPING Accident

Write the complete words in the grid, vertically.  
They make another word in the special squares, horizontally.

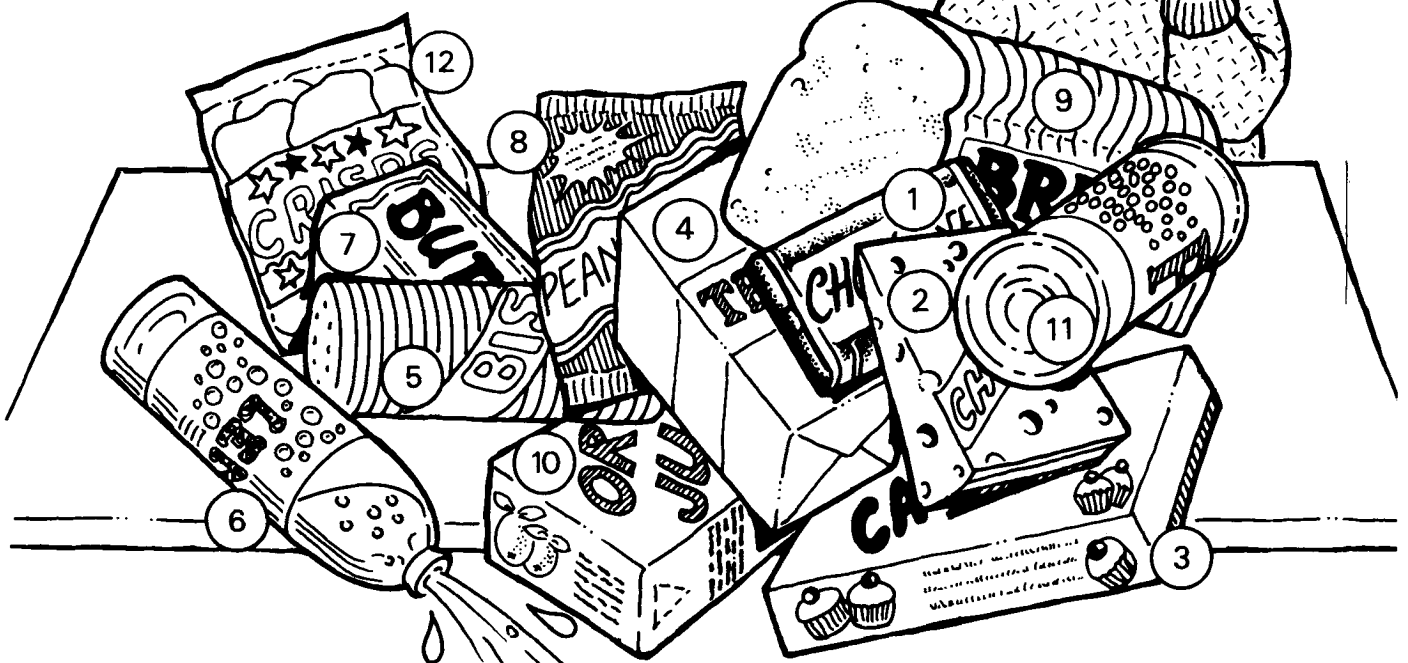







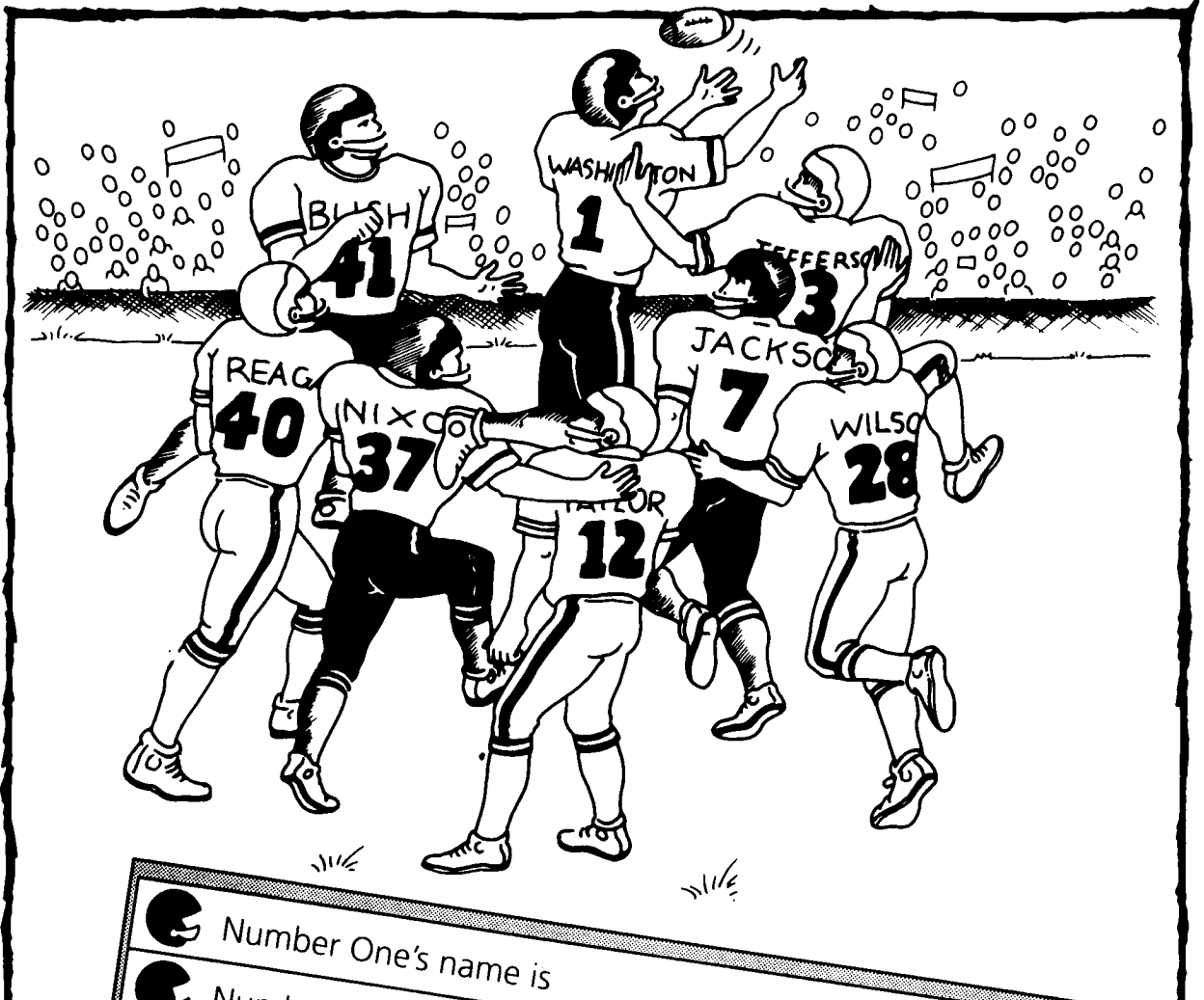

1 C  
2 H  
3 O  
4 C  
5 O  
6 L  
7 A  
8 T  
9 E

3  
4  
5  
6  
7  
8  
9  
10  
11  
12

# AMERICAN FOOTBALL

Look at this picture of an American football match. What do you think the players' names are?



 Number One's name is
 Number Three's name is
 Number Seven's name is
 Number Twelve's name is
 Number Twenty-eight's name is
 Number Thirty-seven's name is
 Number Forty's name is
 Number Forty-one's name is

Question:

What is special about those names?

# Find the words

Find the words and write them in the correct boxes.  
Put a or an with each word, like the examples.

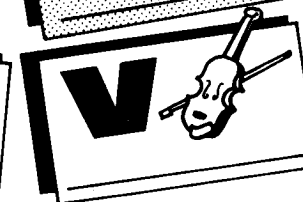
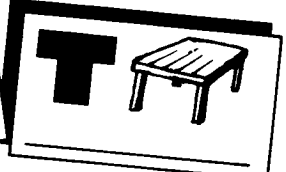
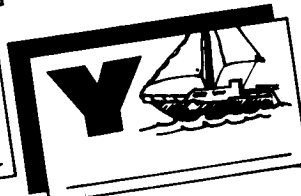
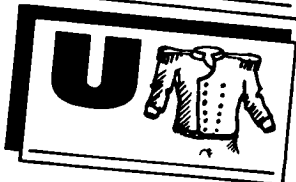
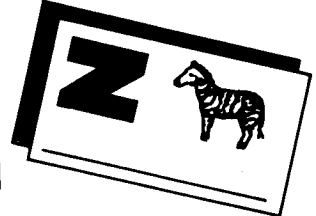
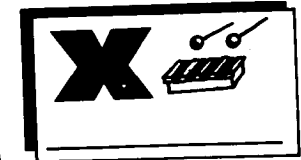
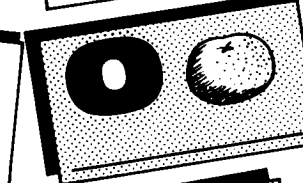
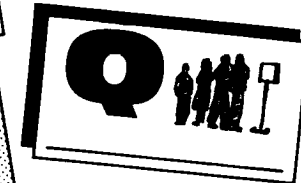
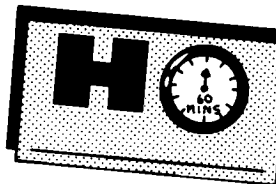
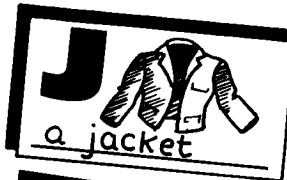
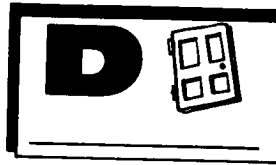
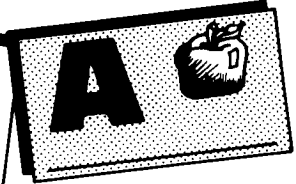
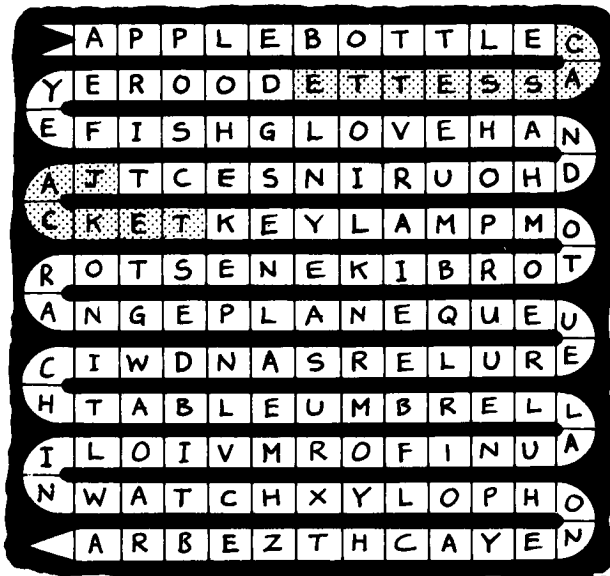

# WIND DAMAGE

Some letters are missing from the buildings after a strong wind.  
Can you replace them?

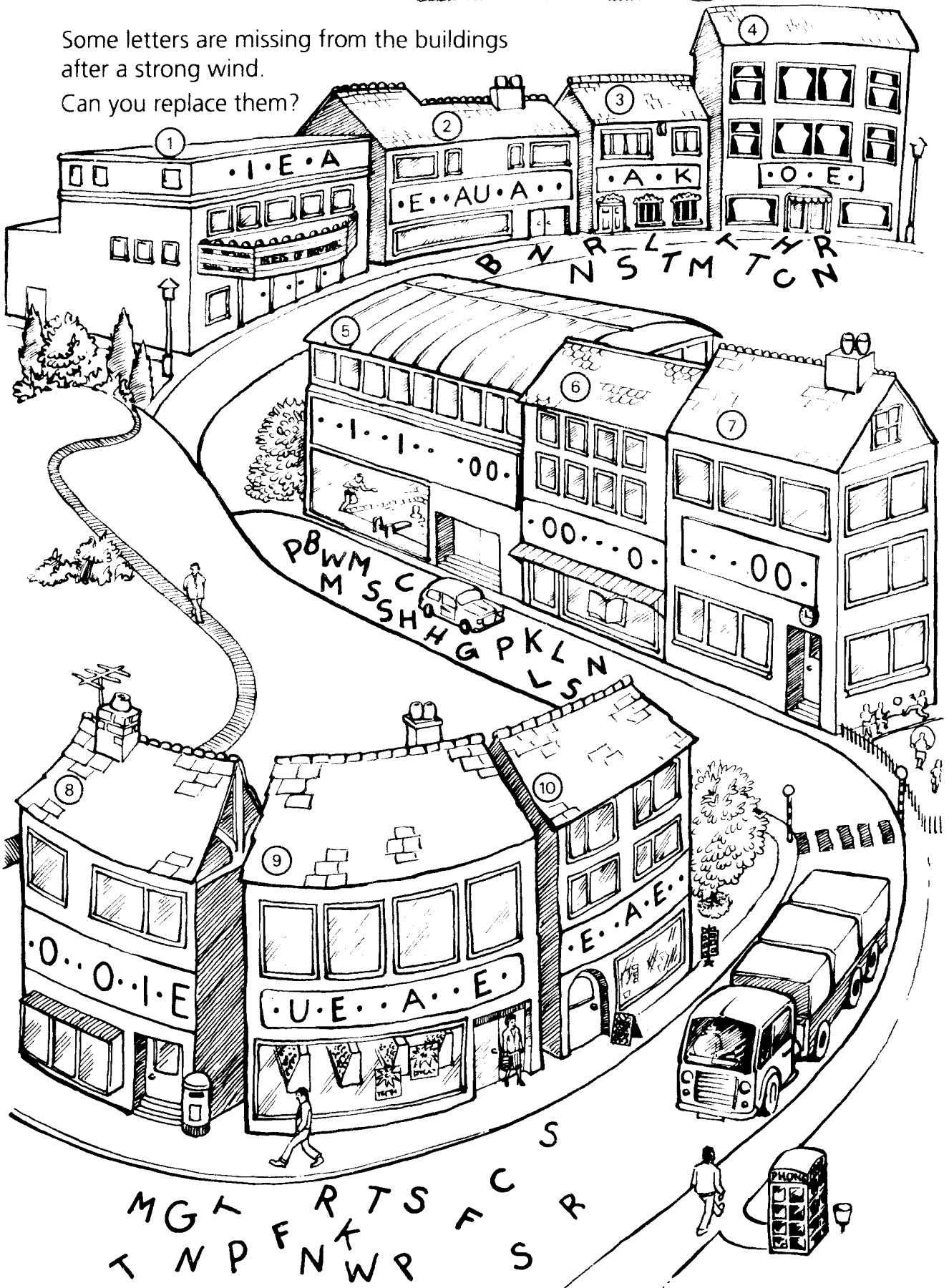

# Crossword Pieces

Assemble the pieces of the crossword onto the grid below, to see six days of the week.

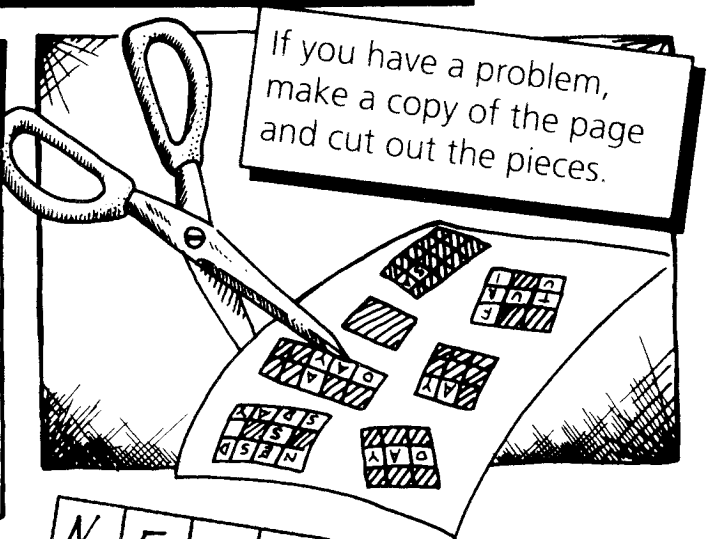
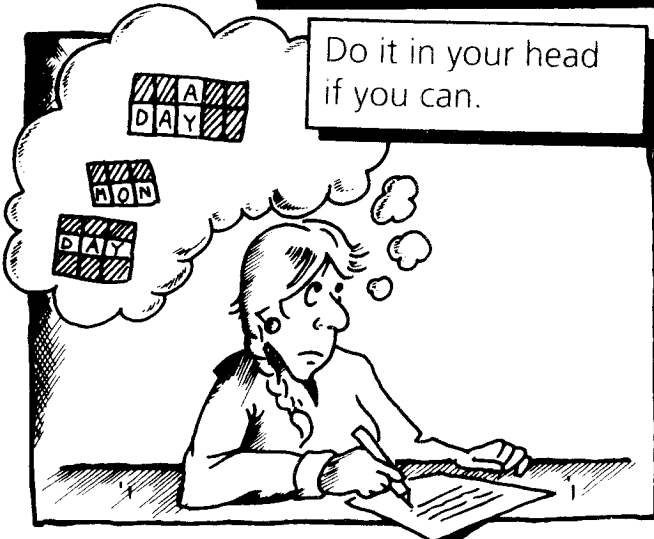

One piece is already in position.

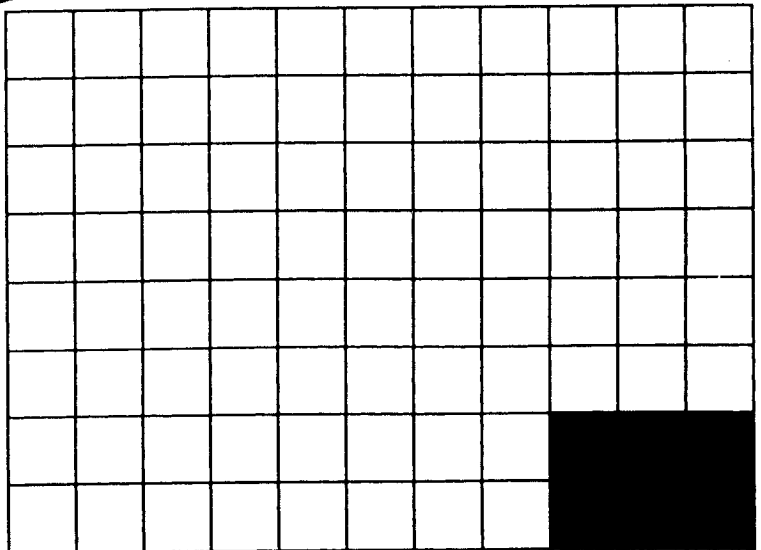
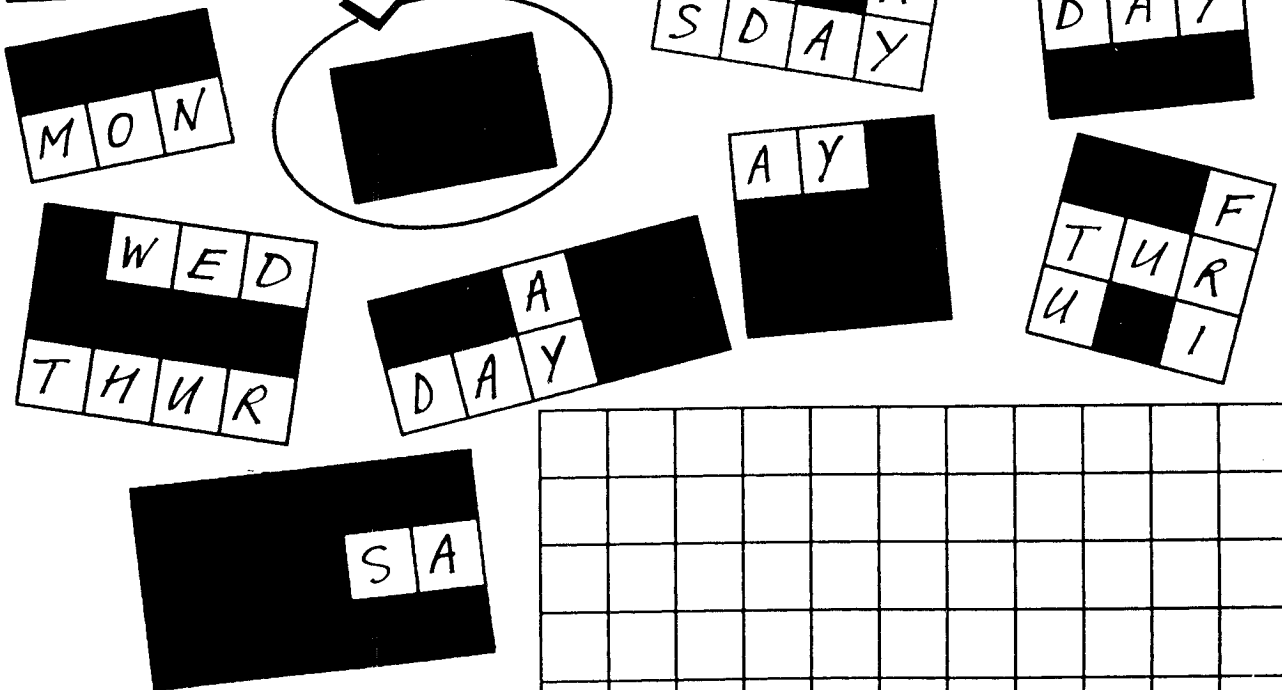

Question:  
Which day is not in the crossword?

# Male and Female

Look at the two crosswords. In Crossword A, every answer is a word for a *male* person. Complete Crossword B: every answer is a word for a *female* person.

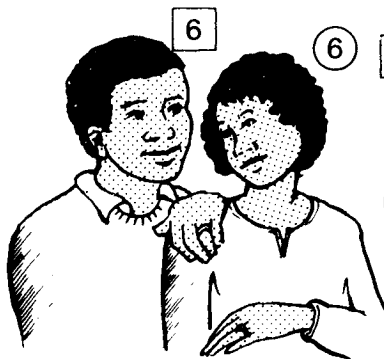
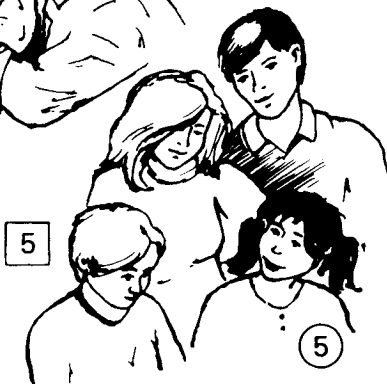
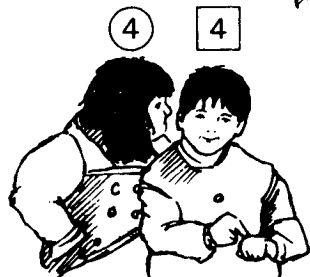
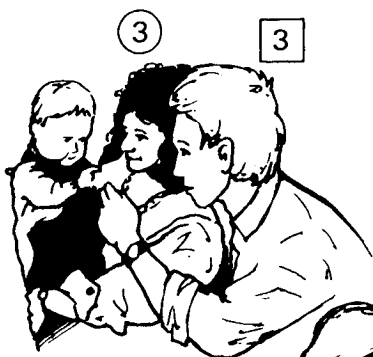

Crossword A

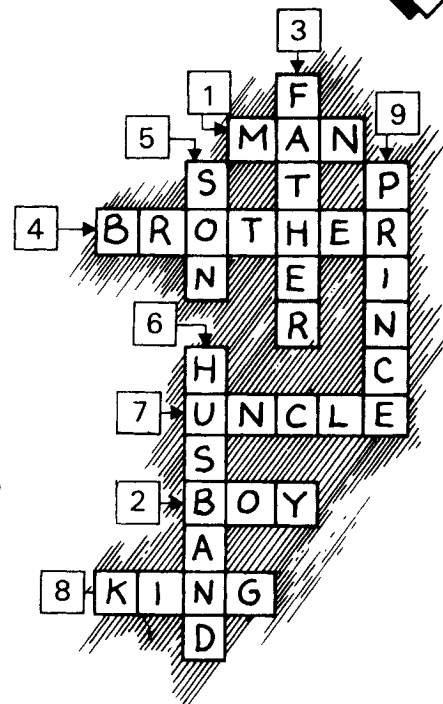

Crossword B

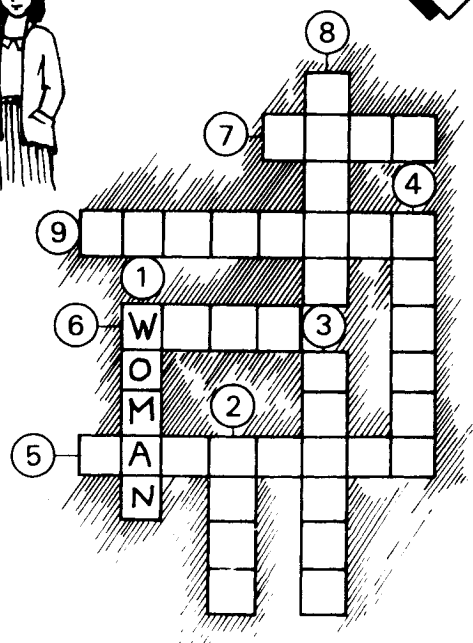





# NAMES

Use the letters to make the names of the people.

All those names are short forms. For example, *Bill* is a short form of *William*, and *Liz* is a short form of *Elizabeth*. Put the other complete forms into the grid. (If you have a problem, all the complete forms are in the box below.)

Daniel David Elizabeth  
Michael Peter Robert  
Susan Thomas William

# THEATRE POSTERS

Put the missing words on the theatre posters. You need the words below, but on the posters you need them in their plural form.

BIRD	MAN	FLY
DAY	SHADOW	SON
FOX	SISTER	FROG

# Do-it-Yourself

All the words in this puzzle are parts of the home – six rooms and two other places. Put the letters of each word in the correct order and write the words in the grid.

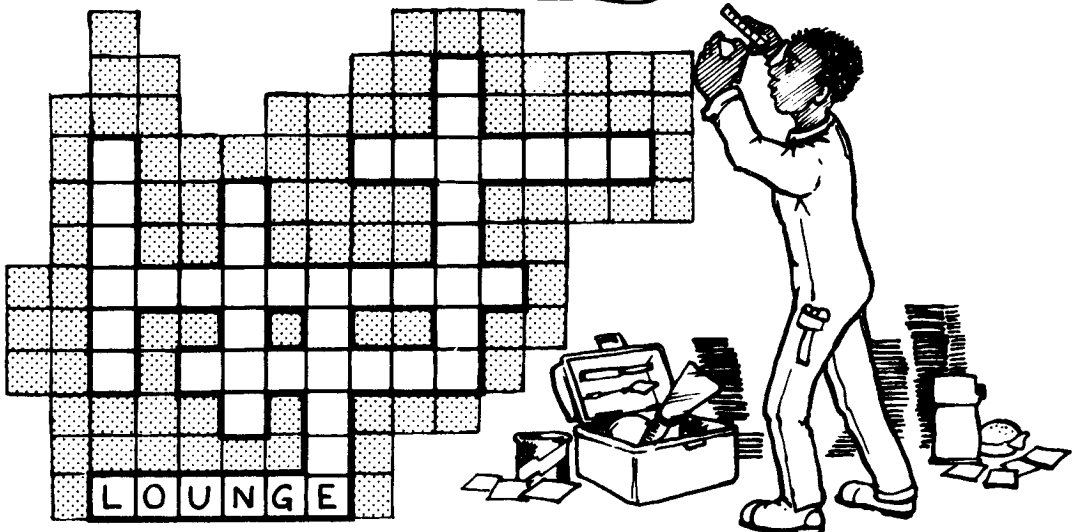
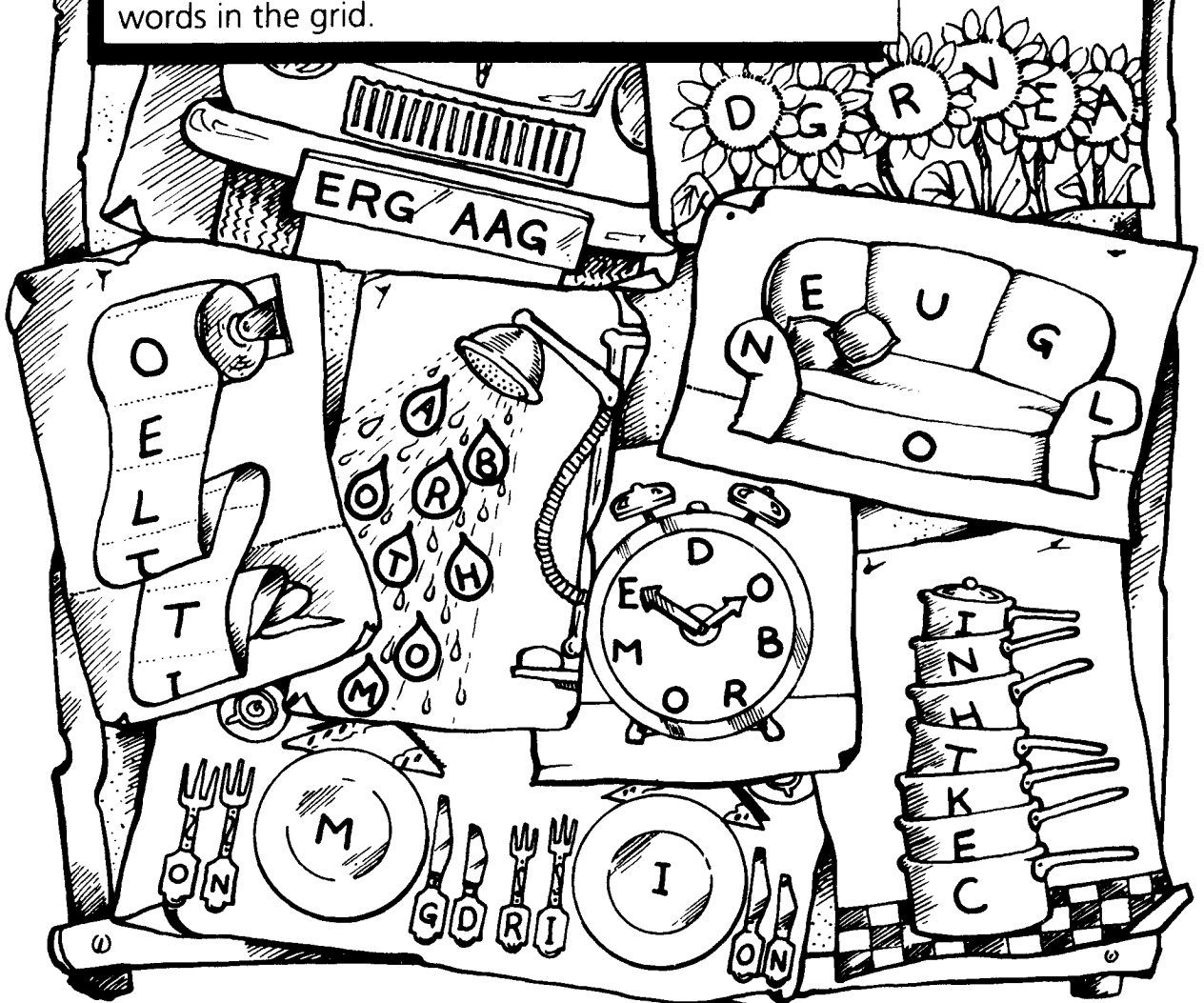

# At the cinema

Read the twenty film titles. (They are the titles of films from the United Kingdom and the United States.)

Ten are about a *male* person. 

Ten are about a *female* person. 

Write the titles in the correct grids : male or female.

QUEEN CHRISTINA  
US 1933

MR SMITH GOES TO WASHINGTON  
US 1939

THE LITTLE PRINCESS  
US 1939

MRS MINIVER  
US 1942

THE MAN FROM MOROCCO  
UK 1944

UNCLE SILAS  
UK 1947

THE BOY WITH GREEN HAIR  
US 1948

MY DAUGHTER JOY  
UK 1950

MY SON JOHN  
US 1952

AUNT CLARA  
UK 1954

GOOD MORNING, MISS DOVE  
US 1955

MY SISTER EILEEN  
US 1955

A KING IN NEW YORK  
UK 1957

A GIRL NAMED TAMIKO  
US 1962

GOODBYE, MR CHIPS  
UK 1969

BROTHER JOHN  
US 1970

THE BOYFRIEND  
UK 1971

THE LITTLE PRINCE  
US 1974

AN UNMARRIED WOMAN  
US 1977

THE GOOD MOTHER  
US 1988





















































QUEEN CHRISTINA



# Countries IN CODE

Use the code to find the names of seven more countries.

one o'clock A	two o'clock E	three o'clock I	four o'clock O	five o'clock U
ten thirty B	nine thirty C	eight thirty D	seven thirty F	six thirty G
one fifteen J	two fifteen L	three fifteen M	four fifteen N	five fifteen P
ten forty-five R	two forty-five S	six forty-five T	one forty-five Y	four forty-five Z

										
A	Y	I	L	T						I T A L Y
										
										
										
										
										
										
										

# AT HOME

Write the words for the things horizontally in the grid. Then find the three English proverbs by taking the correct letters from the grid.

	a	b	c	d	e	f	g	h	i	j	k	l
1	C	O	O	K	E	R						
2												
3												
4												
5												
6												
7												
8												
9												
10												
11												
12												

Proverbs:

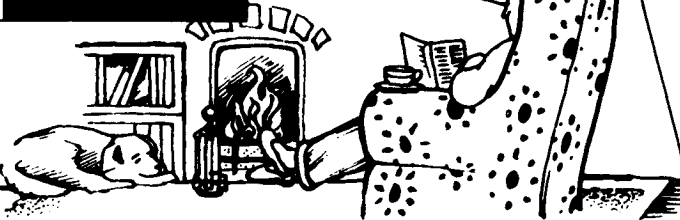

10b	1c	7c	9e		4f	8g		12a	6d	1e	11a	5f		4a	6d	8h		7e	11k	9b	1f	4a		5c	8g	
9a	6d	2b	1f	8h	3a		12c	4i		11g	4c	9b	1a	4d		9d	5c	1d	8h		6d	12e	7c	2b		
5f	9b	3a	9a		12f	1e	4g	9a		7e	11d	7c	2b		10d	3a		9c	8h	4g	9a					

# Book Titles

These books are by writers from the United Kingdom, the United States and Trinidad. Look at the pictures and put the writers' names with the titles.

**John Le Carré**  
GERMANY

**Elizabeth Bowen**  
The House In Paris

**ERNEST HEMINGWAY**  
A fire On The Moon

**Malcolm Lowry**  
Our Man In Havana

**NORMAN MAILER**  
To The Lighthouse

**Francis King**  
Just Above My Head

**A Small Town In Germany**

**Under The Volcano**

**Across The River And Into The Trees**

**A Flag On The Island**

**The Waves Behind The Boat**

**Graham Greene**  
CUBA

**James Baldwin**

**VS. NAIPAUL**  
Virginia Woolf



# VERB CROSSWORD

Put these verbs with the correct pictures.

VERBS

ASK

BEGIN

BORROW

FINISH





PAY

PLAY

PULL

RELAX

WASH

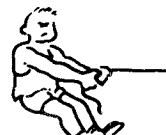

1 BEGIN

2

3

4

5

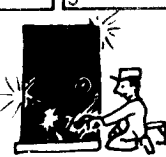
6

7

8

9

VERBS

CARRY

EAT

GO

LISTEN





PUSH

SAY

STOP

WALK

WATCH





10 STOP

11

12

13

14

15

16

17

18

Now put the verbs into the crossword – in their *third person singular* form, like the example.  
(The first group go Across; the second group go Down.)

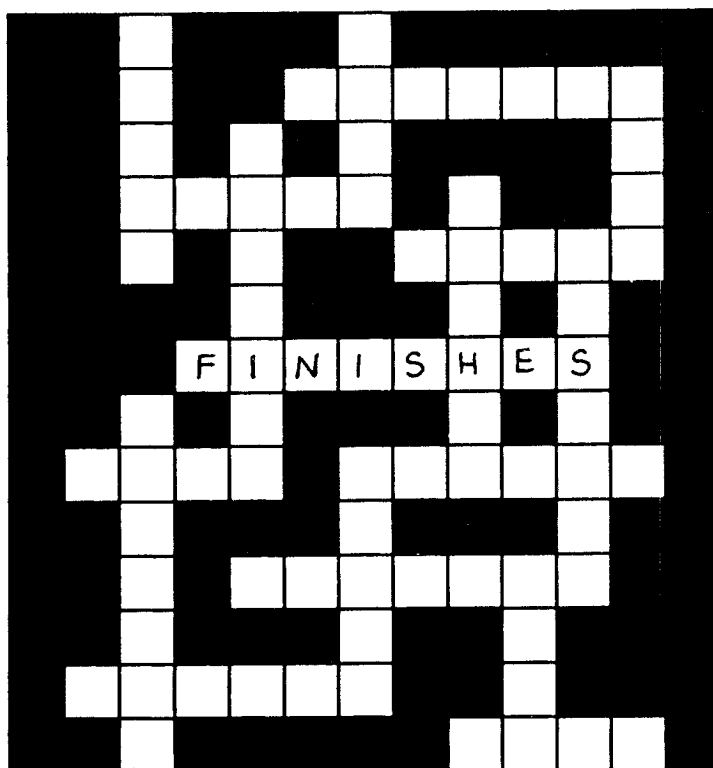

# Add two letters

Write the words on the left. Then add two letters to each word, to get the words on the right.

Here, you've got all the words on the left. Do the words on the right, with the help of the pictures.

I	N		<input type="text"/>	<input type="text"/>	<input type="text"/>	<input type="text"/>	
O	R		<input type="text"/>	<input type="text"/>	<input type="text"/>	<input type="text"/>	
W	E		<input type="text"/>	<input type="text"/>	<input type="text"/>	<input type="text"/>	
H	E		<input type="text"/>	<input type="text"/>	<input type="text"/>	<input type="text"/>	
S	H	E		<input type="text"/>	<input type="text"/>	<input type="text"/>	<input type="text"/>

# TV

## PROGRAMMES

In the crossword there are the names of fifteen programmes from British television.

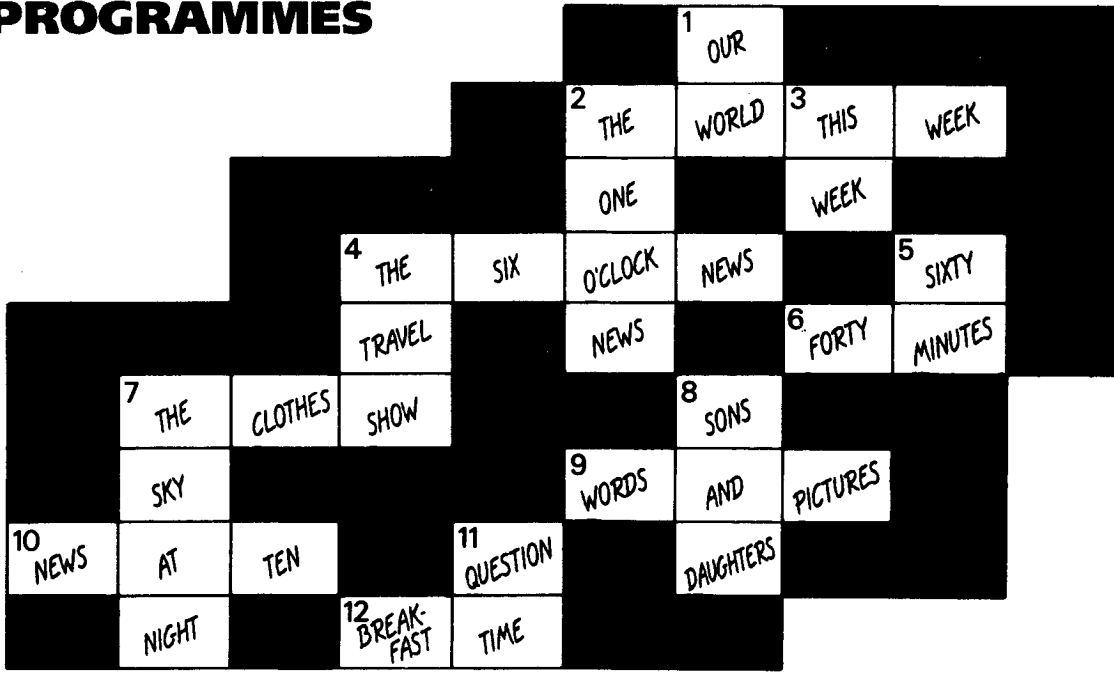

The crossword is complete – but look at the clues below:  
which clue goes with which answer?  
Write the correct number and 'Across' or 'Down'.

<p>9 ACROSS</p>	<p>11 DOWN</p>	<p>1</p>	<p>NEWS</p>	

# JOBS

Separate each line of letters into two jobs.  
The letters for each job are in the correct order.  
The pictures show one job from each pair.  
Here's an example:

1

	TEACHER												
	↑	↑	↑	↑	↑	↑	↑	↑	↑	↑	↑	↑	↑
	T	D	E	O	A	C	C	T	H	E	O	R	R
	↓	↓	↓	↓	↓	↓	↓	↓	↓	↓	↓	↓	↓
	DOCTOR												

Do these in the same way:

2

	R F E P I O R R E T E M R A N												

3

	A P I O R H L I O C S E T E S M A S N												

4

	P B O A L I N K C E W C O L M A E N R K												

5

	S S H O E P A C S R S I E S T T A A N R T Y												



# Song titles

In 1963, the American group The Chiffons recorded a song called 'He's so fine'. From the title you can see that the song is about a man (*he*).

In 1964, the British group The Zombies recorded a song called 'She's not there'. From the title you can see that the song is about a woman (*she*).

THE CHIFFONS 1963 He's so fine

THE ZOMBIES 1964 She's not there

Here are ten more songs. Put  or  in the box after each one.

THE ROLLING STONES 1984 She was hot

THE ROCKIN' BERRIES 1964 He's in town

SISTER SLEDGE 1979 He's the greatest dancer

DONNA SUMMER 1983 She works hard for money

THE BEE GEES 1968 The singer sang his song

THE WALKER BROTHERS 1965 Love her

BILLY FURY 1983 Forget him

RICKY VALANCE 1960 Tell Laura I love her

CAMEO 1984 She's strange

GANG OF FOUR 1979 At home he's a tourist

# BADGES

Assemble the badges.

For each badge, take a piece like this: 

and a piece like this:  and add them to a piece like this: 

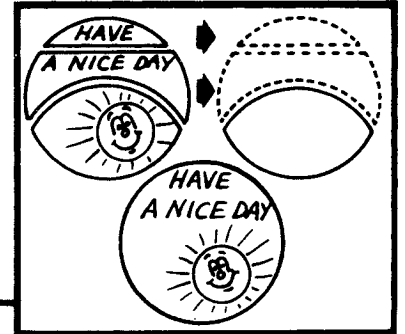

<i>MAKE</i>	<i>I</i>	<i>DON'T READ</i>	<i>I AM NOT A</i>
<i>YES, I'M FAMOUS. DO</i>	<i>I'M A PERSON-</i>	<i>A WOMAN NEEDS A MAN LIKE</i>	
<i>YOU RECOGNISE ME?</i>	<i>LOVE, NOT WAR.</i>	<i>A FISH NEEDS A BIKE.</i>	<i>THIS BADGE!</i>
<i>NOT A NUMBER.</i>	<i>TOURIST. I LIVE HERE.</i>	<i>LOVE NEW YORK.</i>	

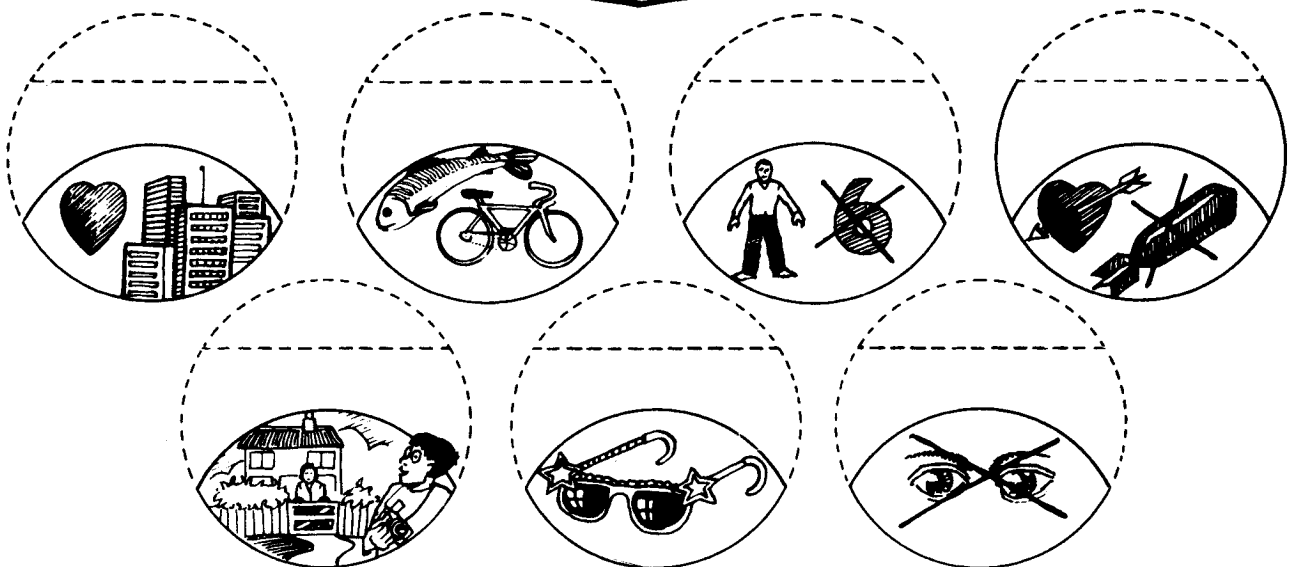



# VERB BACKGAMMON



Do you know the game of 'backgammon'? This puzzle is a bit like that game: there is a board with circular pieces on it. Look at the pieces on the board. They make ten short words. Use the pieces from the box to change each short word into a verb of five letters.

For example:

S E A + P K = S P E A K  
 A T + W C H = W A T C H



# FRUIT

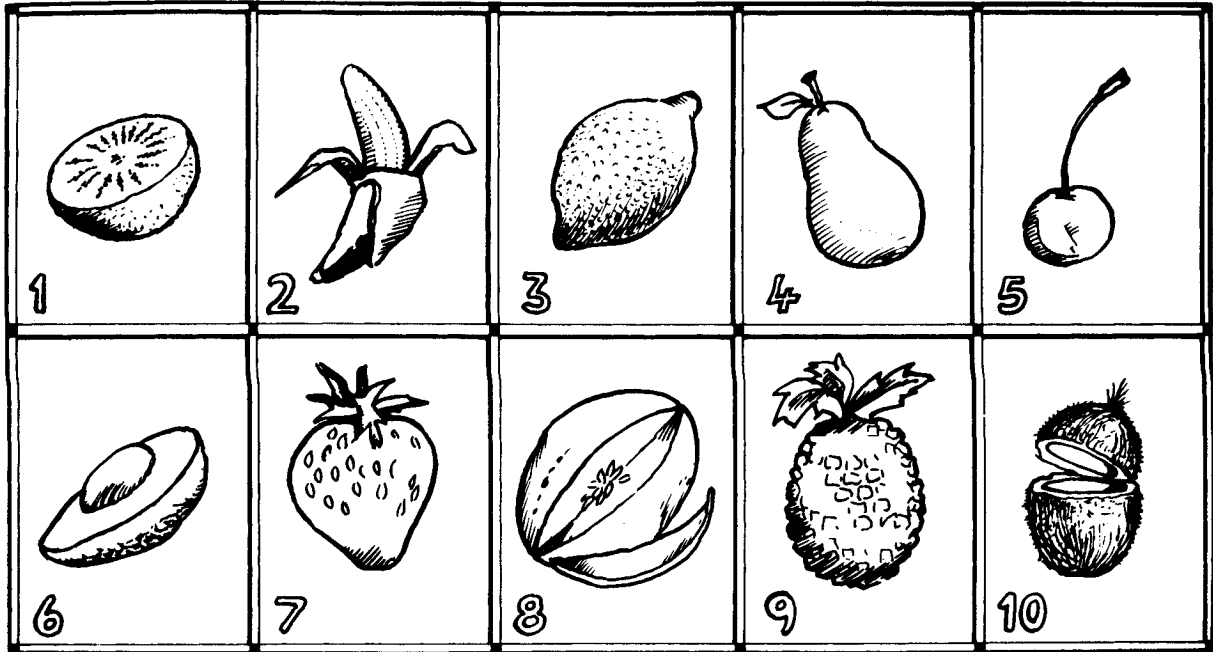

Write the words for the fruit horizontally in the grid. Then find the English proverb by taking the correct letters from the grid.



	a	b	c	d	e	f	g	h	i	j
1	K	I	W	I	F	R	U	I	T	
2										
3										
4										
5										
6										
7										
8										
9										
10										

## PROVERB

7d	2e	6e	9a	9g	3a	7g	2d	6f	9e	7j	1a	5c	8b	9f	7a
10g	5b	7g	6f	3d	5a	1i	6g	7h	2b	1c	6a	5f			



# Mistakes on the

There are nine spelling mistakes in the words on the signpost. Can you correct them?

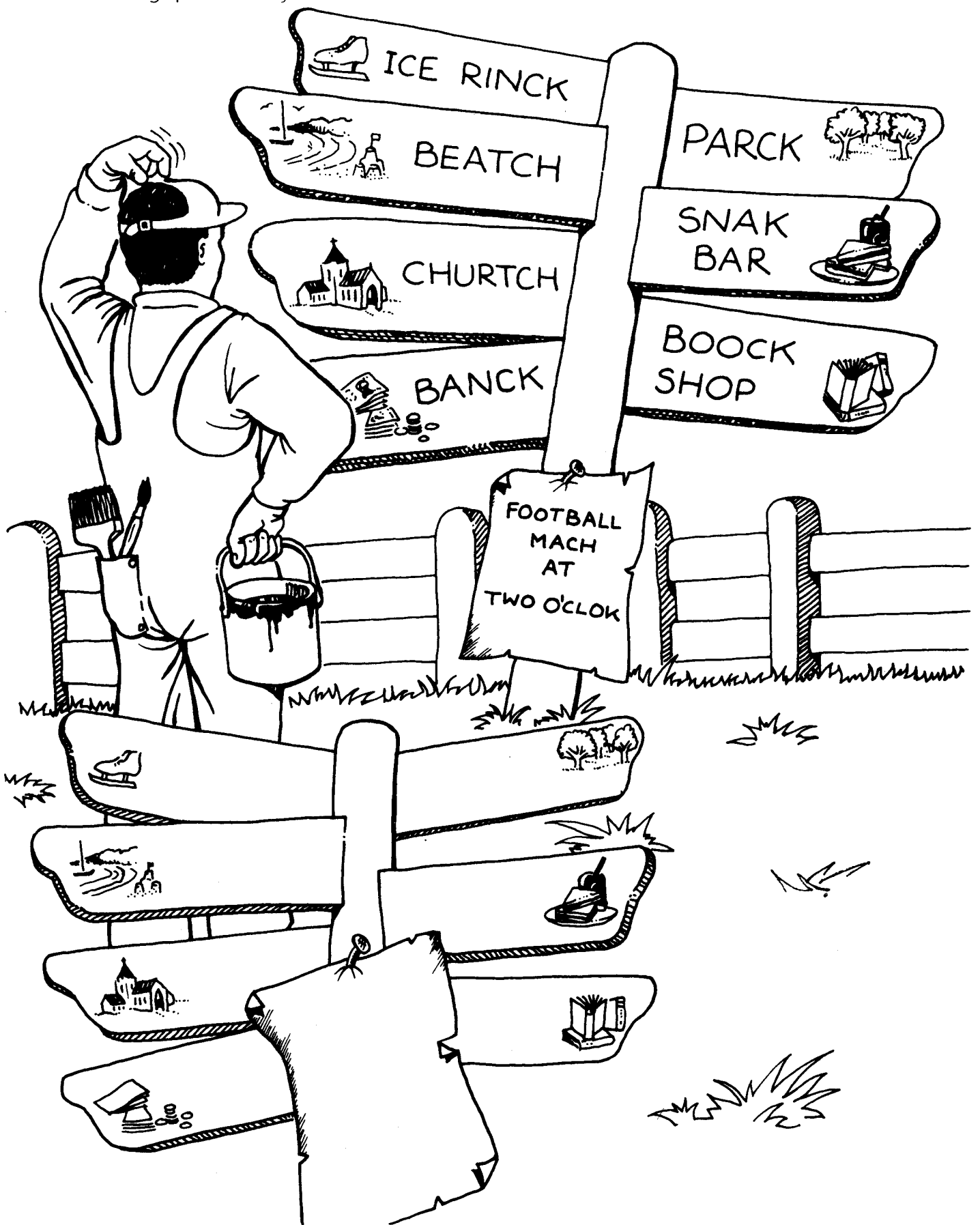

# Pounds and pence

In the nine squares of this grid there are some British coins and notes.

Read each sum of money, and:  
– write it in numbers,  
– mark the correct three squares in the small grid, like the example.

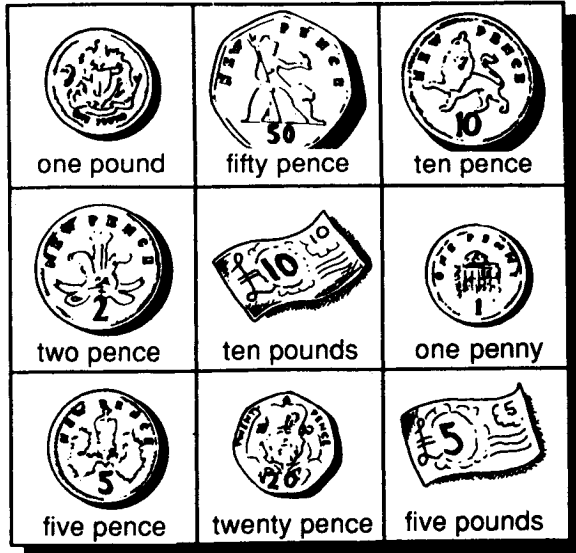

Example:

Ten pounds, three pence  
£10.03p

Five pounds, eleven pence

Ten pounds, fifteen pence

Five pounds, twenty-five pence



Ten pounds, seventy pence

One pound, seven pence

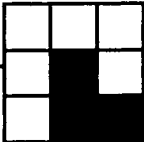
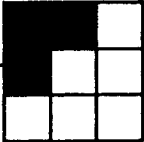
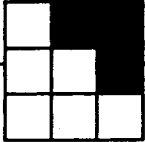
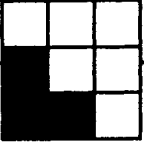
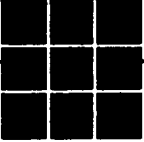

One pound, sixty pence

Sixteen pounds

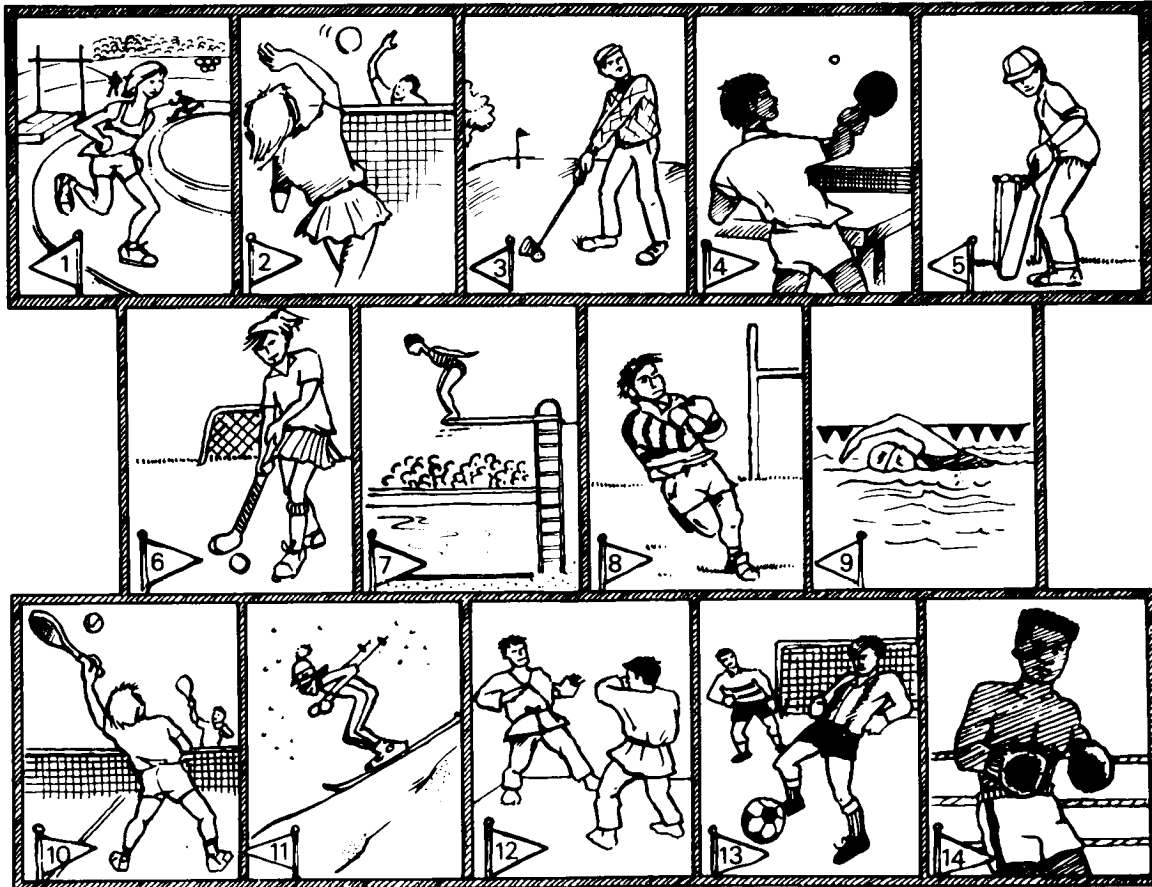

How much money is in *these* squares?

				
<u>£15.20p</u>	_____	_____	_____	_____
<u>Fifteen pounds,</u>	_____	_____	_____	_____
<u>twenty pence</u>	_____	_____	_____	_____

# OLYMPIC RINGS

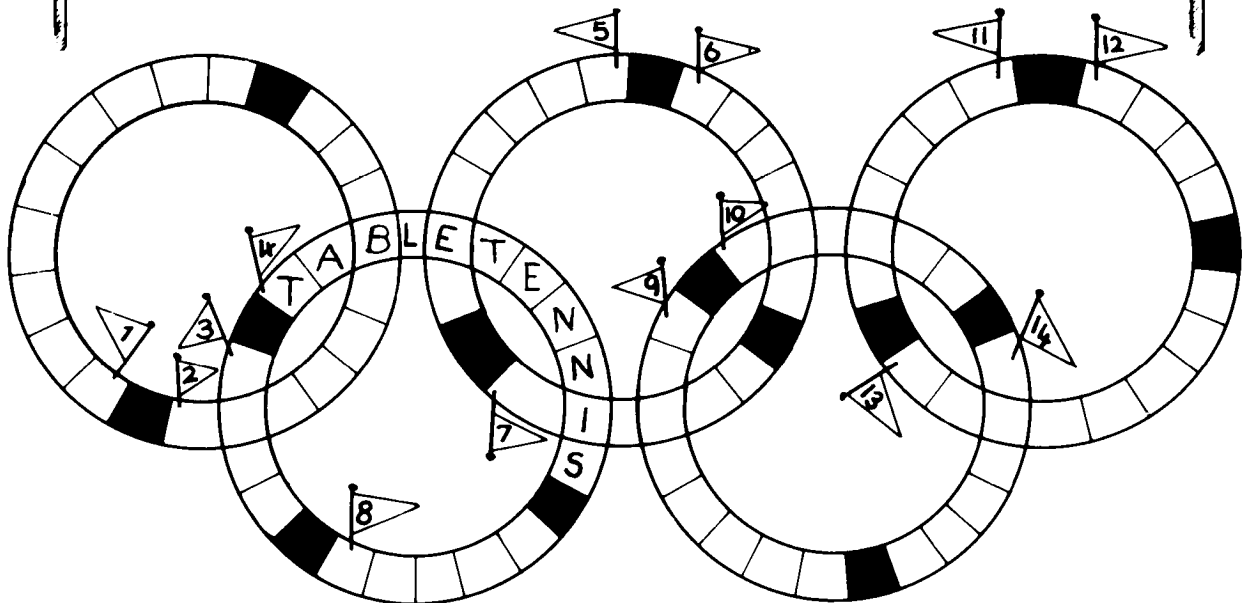

All the answers in this puzzle are sports – Olympic sports and others. Put the words into the rings, in the directions shown by the flags.



# **ENGLISH PUZZLES-1**

## **ANSWERS**

# Solutions

## Coloured Pens

Page 7

1. BLACK
2. YELLOW
3. ORANGE
4. RED
5. GREY
6. BLUE
7. WHITE
8. GREEN
9. BROWN

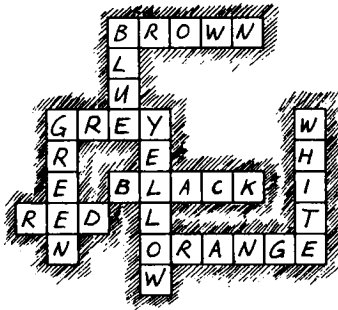

## Film Titles

Page 8

1. Seven Angry Men
2. Three Men on a Horse
3. Two Women
4. Seven Women
5. Three Men in a Boat
6. Two People
7. Ten Tall Men
8. Twelve Angry Men

## Shopping Accident

Page 9

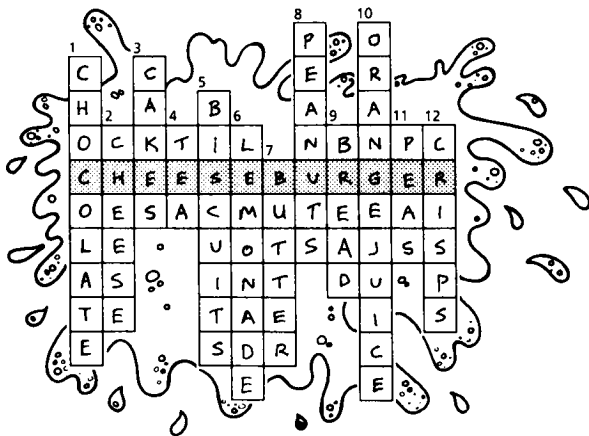

## American Football

Page 10

- Number One's name is WASHINGTON.  
 Number Three's name is JEFFERSON.  
 Number Seven's name is JACKSON.  
 Number Twelve's name is TAYLOR.  
 Number Twenty-eight's name is WILSON.  
 Number Thirty-seven's name is NIXON.  
 Number Forty's name is REAGAN.  
 Number Forty-one's name is BUSH.

Those names are names of American presidents: George Washington, Thomas Jefferson, Andrew Jackson, Zachary Taylor, Woodrow Wilson, Richard Nixon, Ronald Reagan, George Bush. Washington was the 1st president, Jefferson was the 3rd, Jackson was the 7th, etc.

## Find the Words

Page 11

Only the words in the grey squares have an – these are words beginning with A, E, I, O, U (when it is not pronounced /ju:/), and silent H.

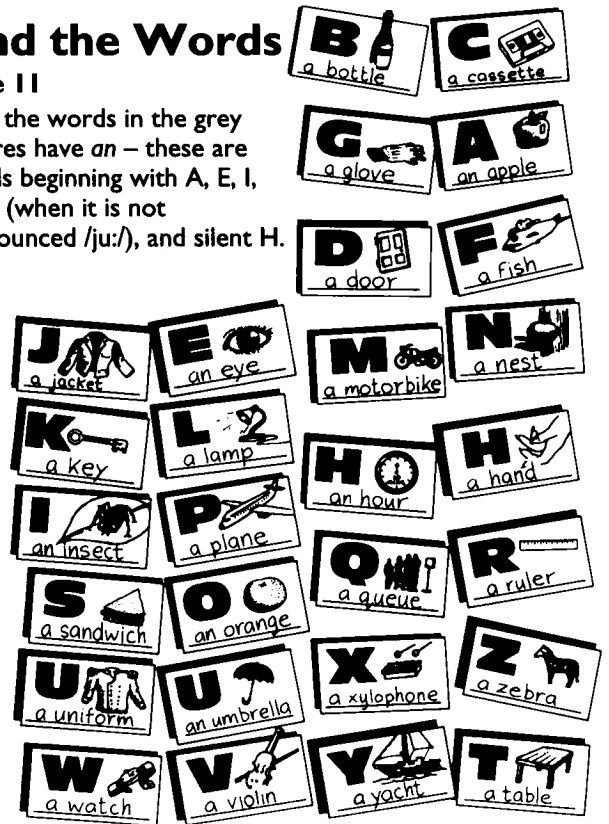

## Wind Damage

Page 12

1. CINEMA
2. RESTAURANT
3. BANK
4. HOTEL
5. SWIMMING POOL
6. BOOKSHOP
7. SCHOOL
8. POST OFFICE
9. SUPERMARKET
10. NEWSAGENT

## Crossword Pieces

Page 13

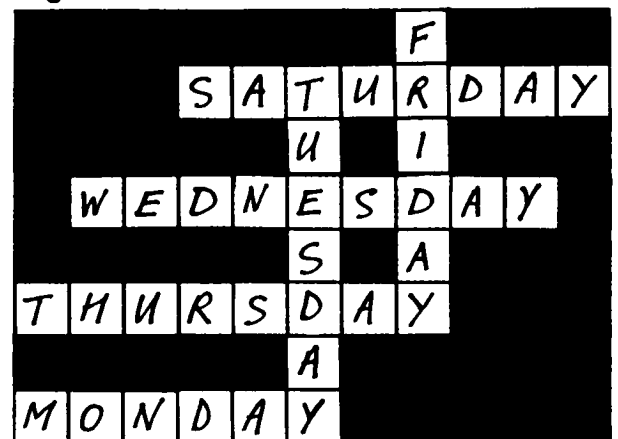

The missing day is SUNDAY.

## Male and Female

Page 14

Crossword B

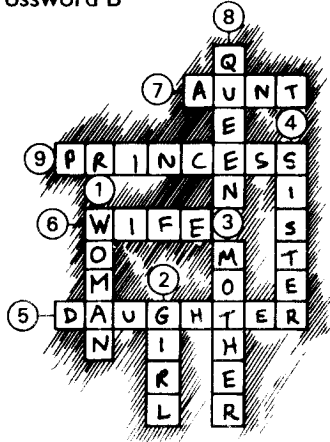

Nouns ending with a consonant +y make their plural with ies (fly – flies).

Nouns ending with x, s, ch or sh make their plural with es (foxes).

Some nouns have irregular plurals (man – men).

## Do-It-Yourself

Page 18

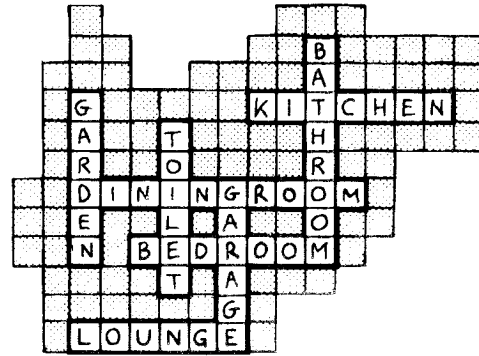

## Add a Letter

Page 15

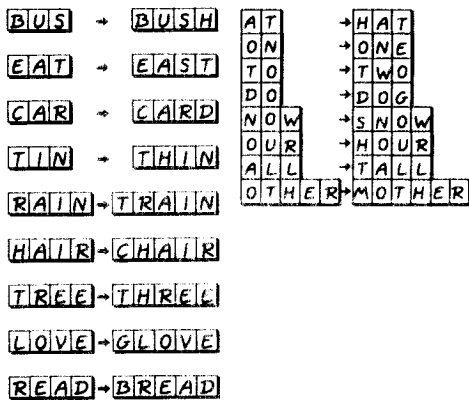

## At the Cinema

Page 19



Mr Smith Goes To Washington	Queen Christina
The Man From Morocco	The Little Princess
Uncle Silas	Mrs Miniver
The Boy With Green Hair	My Daughter Joy
My Son John	Aunt Clara
A King In New York	Good Morning, Miss Dove
Goodbye, Mr Chips	My Sister Eileen
Brother John	A Girl Named Tamiko
The Boyfriend	An Unmarried Woman
The Little Prince	The Good Mother

## Names

Page 16

- LIZ
- BILL
- TOM
- MIKE
- PETE
- SUE
- BOB
- DAN
- DAVE

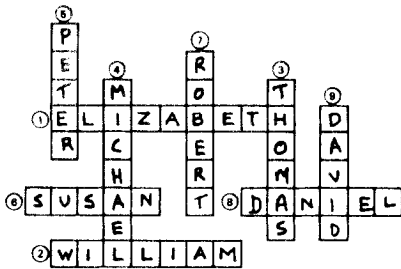

## A Different Alphabet

Page 20

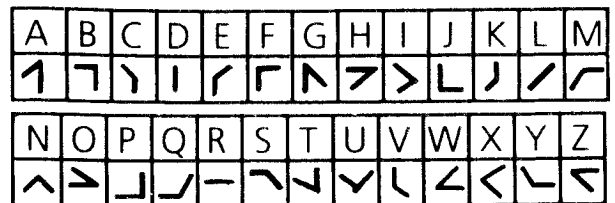

## Theatre Posters

Page 17

- |                        |                     |
|------------------------|---------------------|
| 1. MEN WITHOUT SHADOWS | 5. ALL MY SONS      |
| 2. HAPPY DAYS          | 6. THREE SISTERS    |
| 3. THE BIRDS           | 7. THE FLIES        |
| 4. THE FROGS           | 8. THE LITTLE FOXES |

- |              |                       |
|--------------|-----------------------|
| 1. LIBRARY   | 5. MARKET SQUARE      |
| 2. TAXIS     | 6. HEALTH CENTRE      |
| 3. JAZZ CLUB | 7. SHAKESPEARE AVENUE |
| 4. SWEETSHOP |                       |

Remember:

Most nouns make their plural by adding s to the singular (birds, sisters, sons, frogs, shadows). This includes nouns ending with a vowel + y (days).

In fact, those symbols show the positions of the flags in the semaphore alphabet:

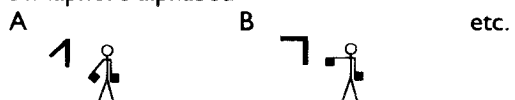

## Countries in Code

Page 21

AYILT	→	ITALY
NSIAP	→	SPAIN
ANAPJ	→	JAPAN
ZRLBAI	→	BRAZIL
CFNEAR	→	FRANCE
ADACNA	→	CANADA
NAGMEYR	→	GERMANY
PATUOGR	→	PORTUGAL

## At Home

Page 22

- |               |             |                   |
|---------------|-------------|-------------------|
| 1. COOKER     | 5. FRIDGE   | 9. TABLE          |
| 2. BED        | 6. BATH     | 10. CHAIR         |
| 3. SOFA       | 7. ARMCHAIR | 11. RECORD-PLAYER |
| 4. TELEVISION | 8. BOOKCASE | 12. WINDOW        |

Proverbs:

Home is where the heart is.  
There's no place like home.  
East, west, home is best.

## Book Titles

Page 23

- |                           |                  |
|---------------------------|------------------|
| The House in Paris        | Elizabeth Bowen  |
| A Fire On The Moon        | Norman Mailer    |
| Our Man In Havana         | Graham Greene    |
| To The Lighthouse         | Virginia Woolf   |
| Just Above My Head        | James Baldwin    |
| A Small Town in Germany   | John le Carré    |
| Under The Volcano         | Malcolm Lowry    |
| Across The River And      |                  |
| Into The Trees            | Ernest Hemingway |
| A Flag On The Island      | V. S. Naipaul    |
| The Waves Behind The Boat | Francis King     |

## Verb Crossword

Page 24

- |           |            |           |
|-----------|------------|-----------|
| 1. BEGIN  | 7. ASK     | 13. CARRY |
| 2. PLAY   | 8. PAY     | 14. WATCH |
| 3. WASH   | 9. FINISH  | 15. WALK  |
| 4. RELAX  | 10. STOP   | 16. SAY   |
| 5. PULL   | 11. LISTEN | 17. EAT   |
| 6. BORROW | 12. PUSH   | 18. GO    |

Remember:

Most verbs add s (begins, pulls, borrows, asks, stops, listens, walks, eats). This includes verbs ending with a vowel + y (plays, pays, says).

Verbs ending with a consonant + y use ies (carry – carries).

Verbs ending with x, s, ch, sh or o add es (washes, relaxes, finishes, pushes, watches, goes).

## Add Two Letters

Page 25

TIN	→	STREET
TREE	→	PENCE
ONE	→	ADDRESS
PEN	→	TRAIN
DRESS	→	PHONE

IN	→	WINE
OR	→	DOOR
WE	→	WEST
HE	→	HEAD
SHE	→	SHELL

## TV Programmes

Page 26

9 ACROSS	11 DOWN	4 DOWN	10 ACROSS	3 DOWN
1 DOWN	6 ACROSS	12 ACROSS	2 ACROSS	2 DOWN
8 DOWN	7 ACROSS	4 ACROSS	7 DOWN	5 DOWN

## Jobs

Page 27

2	REPORTER
	R F E P I O R R E T E M R A N
	FIREMAN
3	AIR HOSTESS
	A P I O R H L I O C S E T E S M A S N
	POLICEMAN
4	POLICEWOMAN
	P B O A L I N K C E W C O L M A E N R K
	BANK CLERK
5	SHOP ASSISTANT
	S S H O E P A C S R S I E S T T A A N R T Y
	SECRETARY

## Song Titles

Page 28

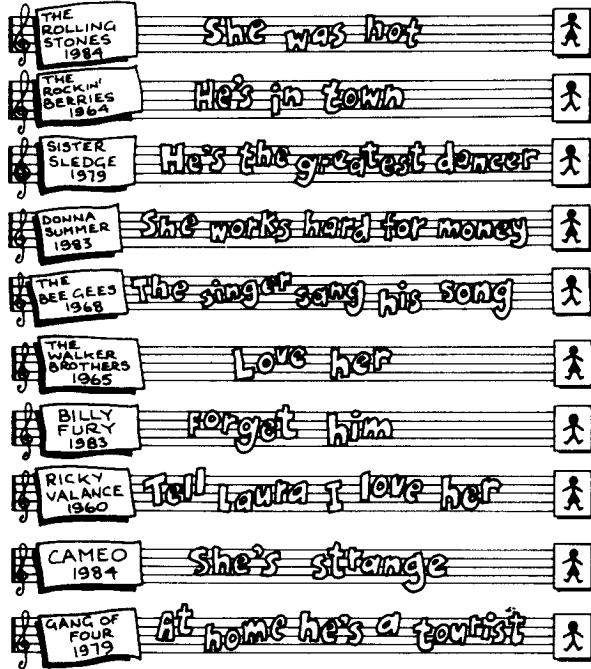

## Badges

Page 29

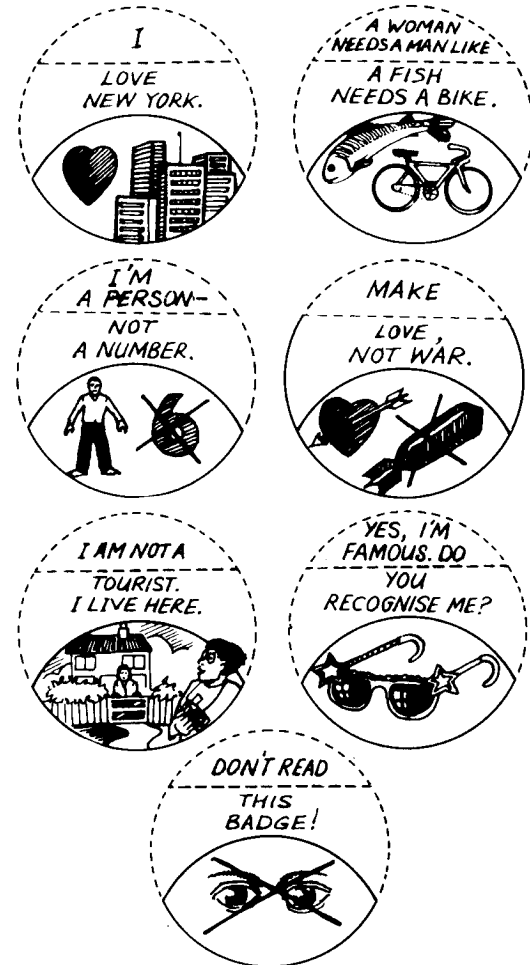

## Verb backgammon

Page 30

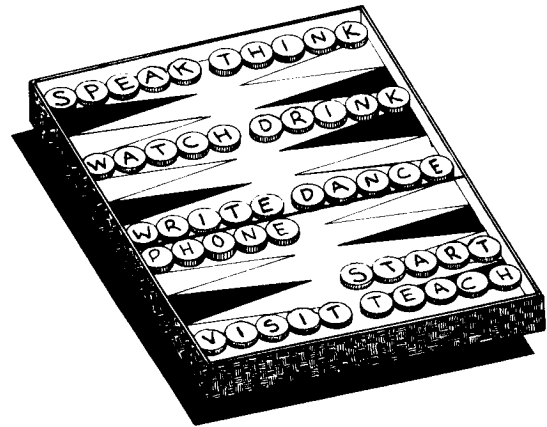

## Fruit

Page 31

1. KIWI FRUIT
2. BANANA
3. LEMON
4. PEAR
5. CHERRY
6. AVOCADO
7. STRAWBERRY
8. MELON
9. PINEAPPLE
10. COCONUT

Proverb: An apple a day keeps the doctor away.

## Mistakes on the Signpost

Page 32

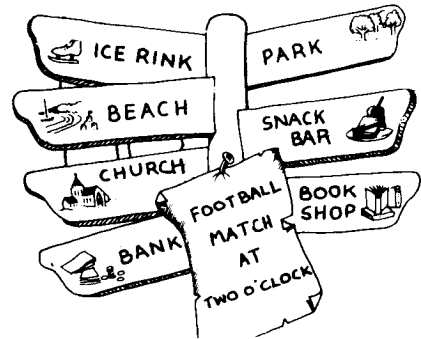

## Pounds and Pence

Page 33

Ten pounds, three pence £10.03p	Five pounds, eleven pence £5.11p	
Ten pounds, fifteen pence £10.15p	Five pounds, twenty-five pence £5.25p	
Ten pounds, seventy pence £10.70p	One pound, seven pence £1.07p	
One pound, sixty pence £1.60p	Sixteen pounds £16	
£15.20p Fifteen pounds, twenty pence	27p Twenty-seven pence	£1.52p One pound, fifty-two pence
£16.88p Sixteen pounds, eighty-eight pence	61p Sixty-one pence	

Remember: In conversation, we often say, for example, 'Fifteen pounds, twenty' or 'Fifteen twenty' instead of 'Fifteen pounds, twenty pence'.



# Musical Instruments

Page 34

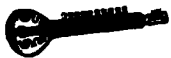
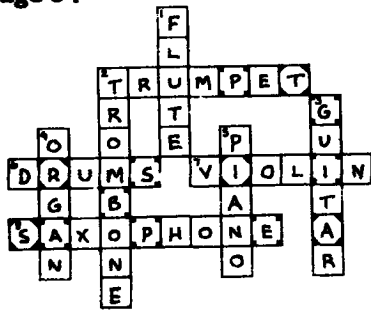

GUITAR



BAGPIPES

# Write the Clues

Page 35

Across

- 1. STUDY
- 4. SPELL
- 6. GET
- 7. START
- 9. LEAVE
- 10. SWIM
- 12. GO
- 14. TAKE
- 15. HOPE
- 16. OPEN

Down

- 2. TELL
- 3. DO
- 5. EAT
- 7. SKATE
- 8. RUN
- 9. LISTEN
- 11. WORK
- 13. STOP
- 15. HELP

To make their *ing*-form, most verbs just add *ing* (studying, spelling, starting, going, opening, telling, doing, eating, listening, working, helping).

Verbs ending with a consonant + *e* lose the *e* (leave – leaving, take – taking, hope – hoping, skate – skating).

Some verbs double the final consonant (get – getting, swim – swimming, run – running, stop – stopping).

# Radio Programmes

Page 36

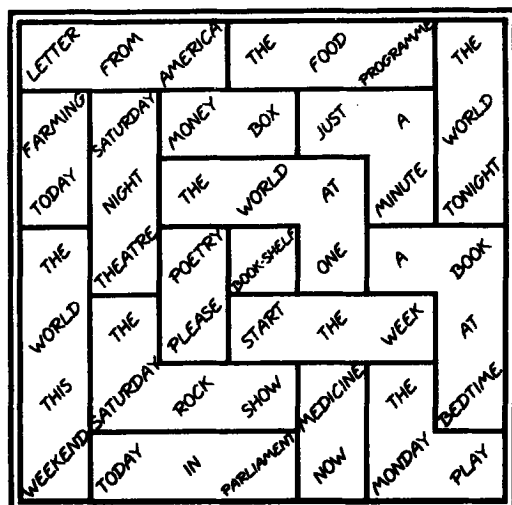

# Fifteen Records

Page 37

is	has	POSSESSIVE
2, 3,	6, 12	1, 4, 7,
5, 8,		9, 13,
10, 11,		14
15		

# Round and Round

Page 38

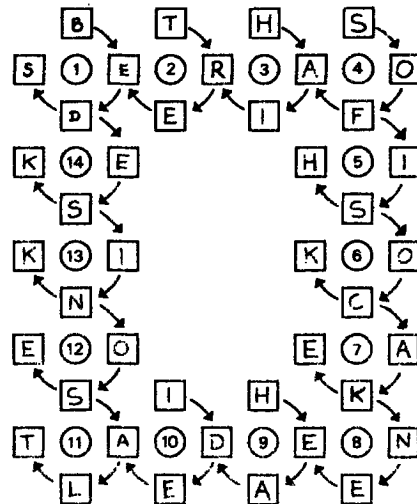

# Letters or Words?

Page 39

The letter	T	sounds like the word	tea
The letter	Q	sounds like the word	queue
The letter	Y	sounds like the word	why
The letter	U	sounds like the word	you
The letter	R	sounds like the word	are
The letter	P	sounds like the word	pea
The letter	C	sounds like the words	see and sea
The letter	I	sounds like the words	eye and I

- 1. Be careful!
- 2. Are you English?
- 3. seaplane
- 4. Queue here.
- 5. teapot
- 6. See you later.
- 7. peanuts
- 8. I'm ill.

# Daily Newspapers

Page 40

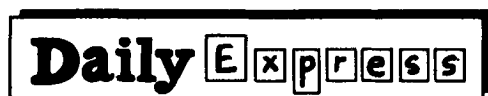

## Add Three Letters

Page 41

NO	→	NORTH
TO	→	TORCH
RED	→	RECORD
PEN	→	PENCIL
FAT	→	FATHER
ICE	→	POLICE
OTHER	→	BROTHERS
US	→	HOUSE
IS	→	DISCO
GO	→	GLOVE
BUT	→	BUTTER
ARE	→	GARDEN
ONE	→	ORANGE
TRUE	→	TRUMPET
THEN	→	KITCHEN

## Rhyming Pairs

Page 42

tea	tree	beer	here
there	chair	hot	what
but	nut	cat	that
put	foot	do	blue
come	some	go	snow
home	Rome	now	how

## Olympic Rings

Page 43

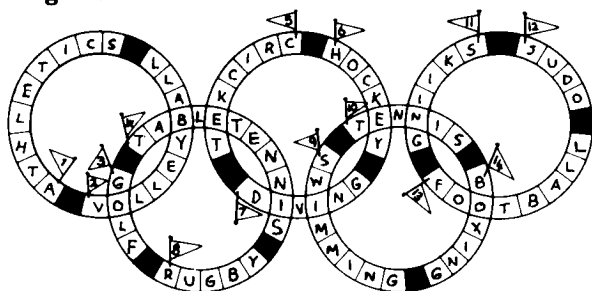

## Computer Keyboard

Page 44

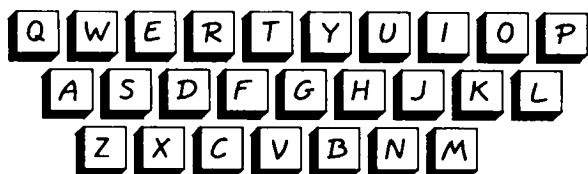

## Animals

Page 45

- lion
- tortoise
- chameleon
- alligator
- parrot
- kangaroo
- rabbit
- cobra
- camel
- spider

## Shapes and Letters

Page 46

- SUN
  - SEA
  - PUT
  - EAST
  - TEA
  - PEN
- The word with all seven letters is: PEANUTS

## More Newspapers

Page 47



## Radio Stations

Page 48

- BBC Radio 2
- BBC Radio 4
- L.B.C.
- BBC Radio 3
- Capital Radio
- BBC Radio 1
- G.L.R.

## Past and Present

Page 49

COME	RUN	DRINK
CAME	RAN	DROOK
FALL	GIVE	RTDE
FELL	GAVE	RODE
RING	SWIM	WIN
RANG	SWAM	WON
THROW	WRITE	SIT
THREW	WROTE	SAT

## Books, Books, Books

Page 50

- A ROOM WITH A VIEW E. M. Forster  
 THEY CAME TO A CITY J. B. Priestley  
 TWELFTH NIGHT William Shakespeare  
 OTHELLO William Shakespeare

# ENGLISH PUZZLES-2

# TOP HALF ONLY

Complete the other words and pictures by adding the bottom half of each one. Draw a line from each word to the correct picture.

- PLATE
- KNIFE
- CUP
- GLASS
- BOWL
- BOTTLE
- COON
- FLID
- CAUCEDAN
- EDVING DAN

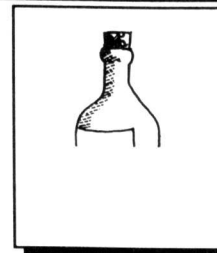
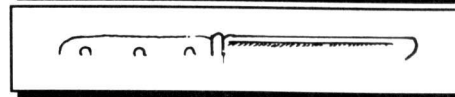
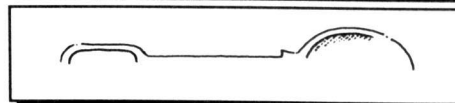
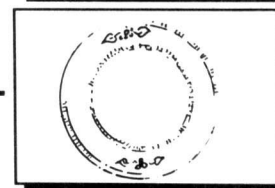
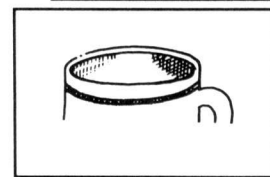
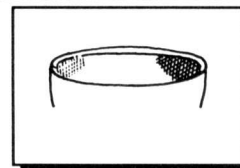
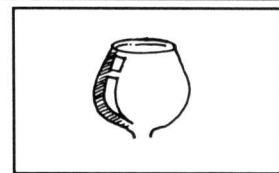
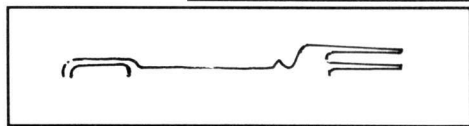
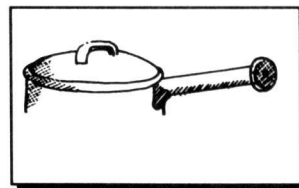

Question:

In which room could you find those things? Complete the word:

KITCHEN

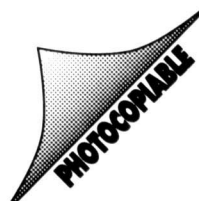

# Well played!

Do you know the British game called 'darts'? This board is a bit like the board used for darts, but it has pieces of words on it:

1

Assemble the pieces to make six words - they are all words you can use to give your opinion of something. For each word, take a piece from the black circle, a piece from the grey circle and a piece from the white circle.



Here is one word - find the other five:

MARVELLOUS

**Question:**

Five of the words mean something is *good* - but one means something is *bad*: which one?

2

Use the pieces of words on these darts to make:

- a word meaning 'very interesting',

- a word meaning 'not interesting'.

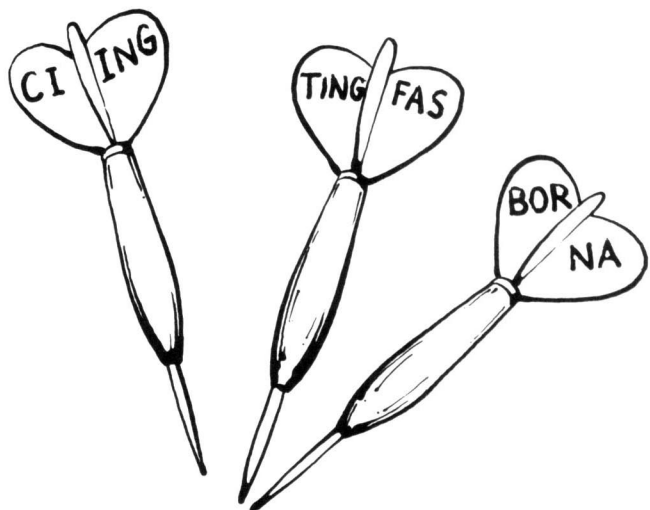



PHOTOCOPIABLE

# People and things

Read the eleven film titles. (They are the titles of films from the United Kingdom and the United States.) By reading each title, decide if the film could be about ...

...a person 

...a thing 

...a person or a thing 





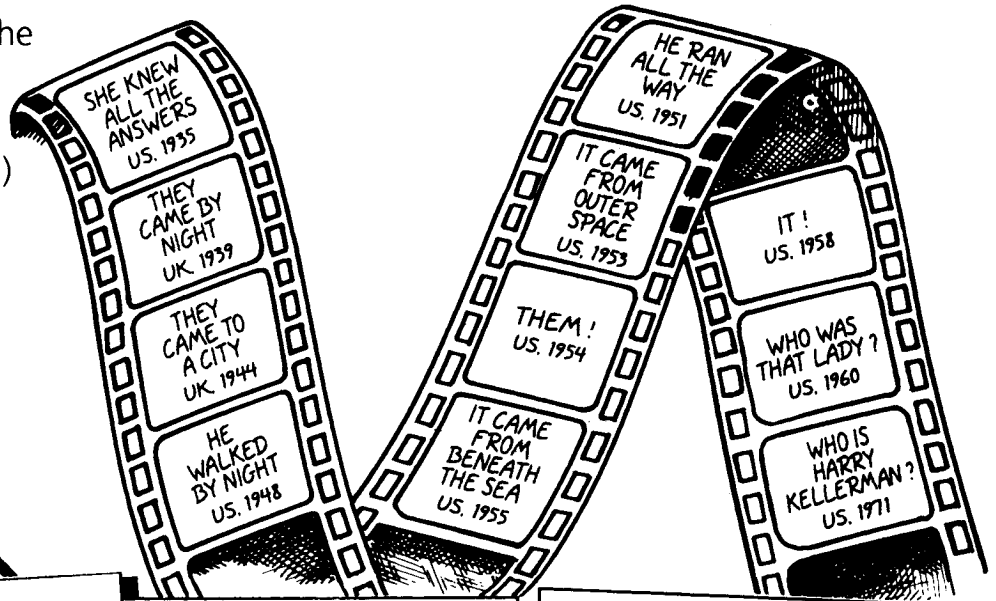

...people 

...things 

...people or things 

Write the titles in the correct boxes. (Be careful - you don't need *all* the boxes!)



		
		

Question:

In the first box, which films are about a man?  
And which films are about a woman?

# What's on the menu?

After an accident with some soup, the first menu is difficult to read. Write the words clearly on the second menu.

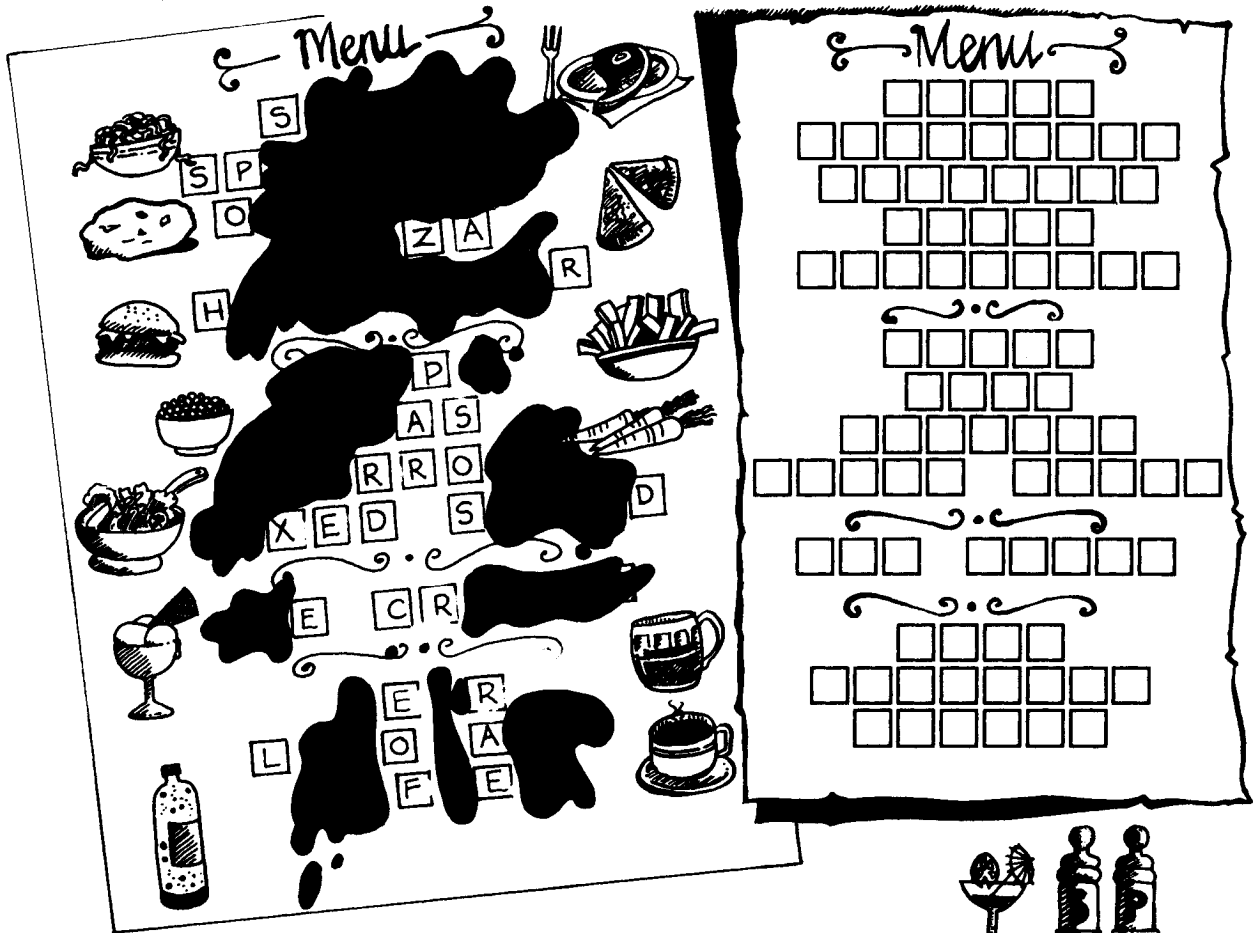

Find all the words from the menu on this corner of the tablecloth - like this:

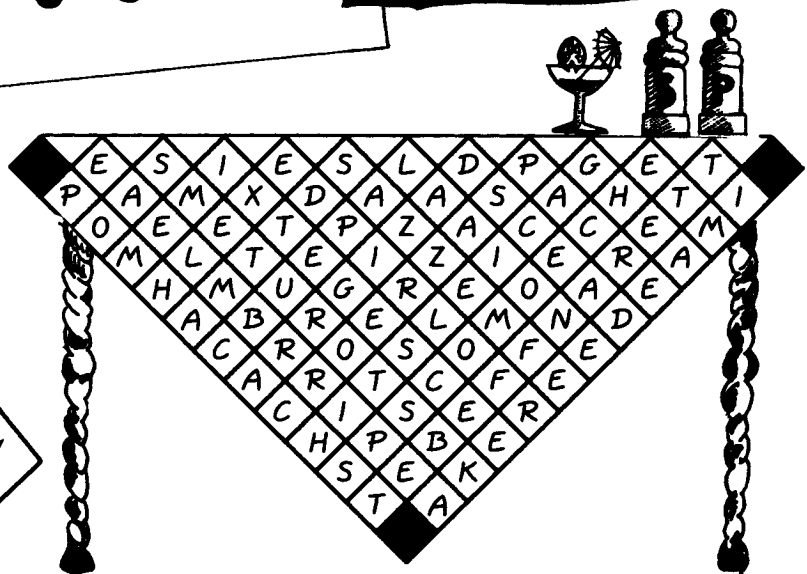
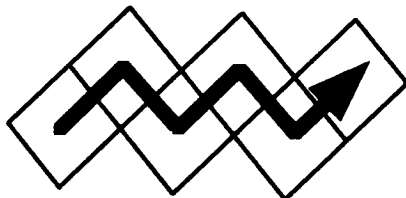

# STRANGE PICTURES

Here's an old joke:

What's this?

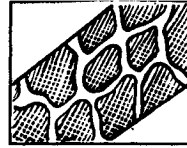

- A **giraffe**,  
passing a **window**.

Here are six more pictures and six more descriptions.  
Put the correct number with each picture.

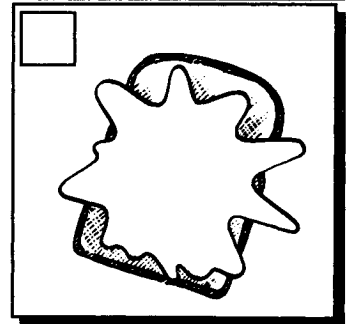
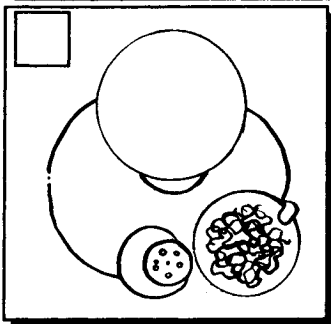
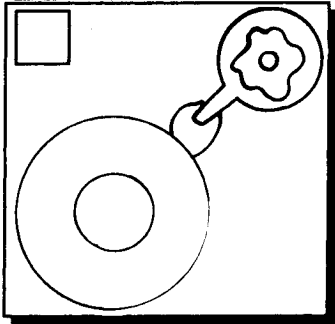
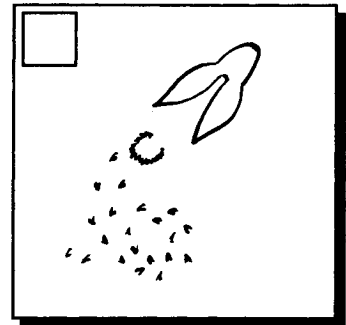
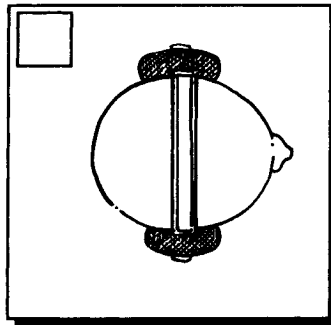
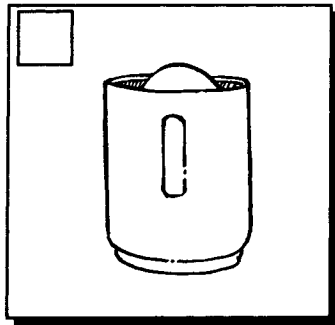

- 1 A **man** with no **hair**, listening to some **music**.
- 2 A **piece** of **bread** with a lot of **butter** on it.
- 3 A **policeman**, eating **spaghetti** and drinking **lemonade**.
- 4 A **cup** of **tea** with a lot of **sugar** in it.
- 5 A **rabbit**, dancing in the **snow**.
- 6 A **cowboy** frying an **egg**.

Look at the eighteen **nouns** in the descriptions. In their uses here, nine are *countable* and nine are *uncountable*. Put them into the correct boxes.

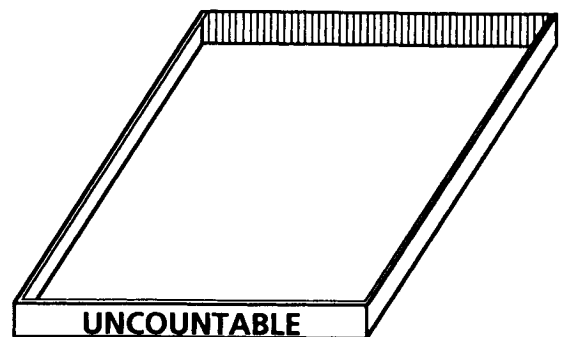
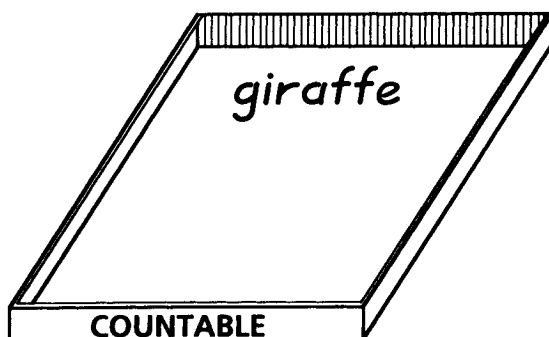



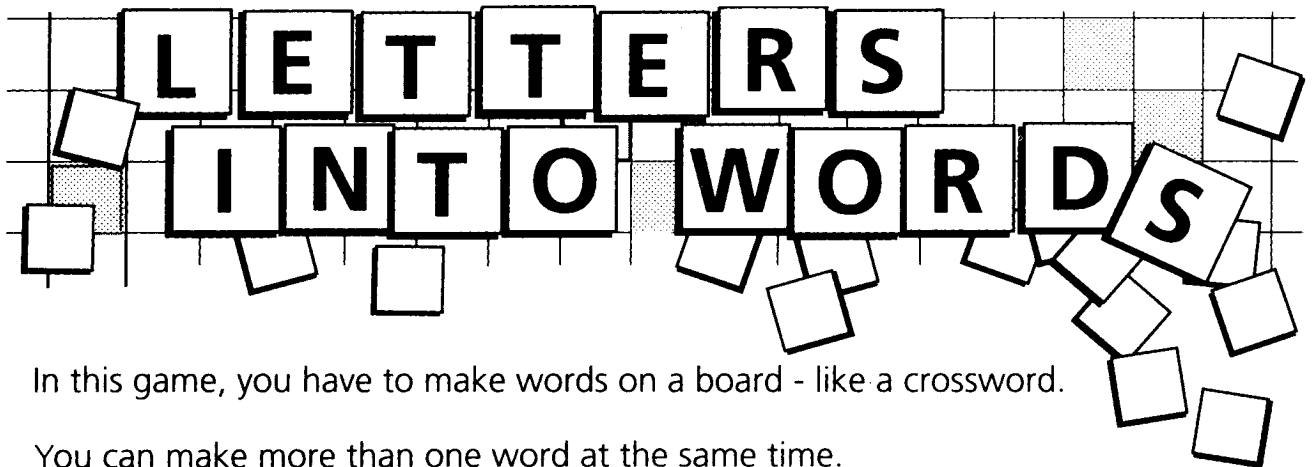

In this game, you have to make words on a board - like a crossword.

You can make more than one word at the same time.  
Here's an example:

If these words are already  
on the board:

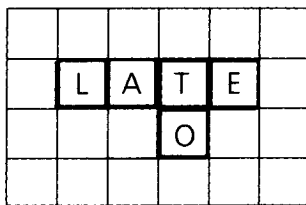

you can add these  
letters:

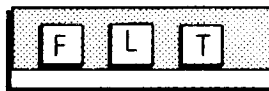

and make *two* new  
words at the same  
time (*LEFT* and *OF*):

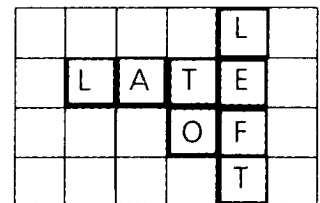

Try the two puzzles below.



REMEMBER:

When you put your letters on the board, you have to put them all in one line of squares. ( It can be a horizontal line or a vertical line.)

Can you put these three letters on the board, to make *four* new words?

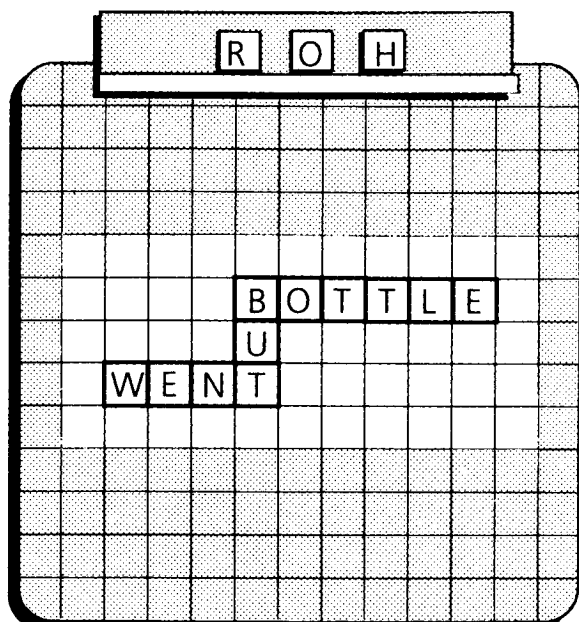

And can you put these five letters on the board, to make *five* new words?

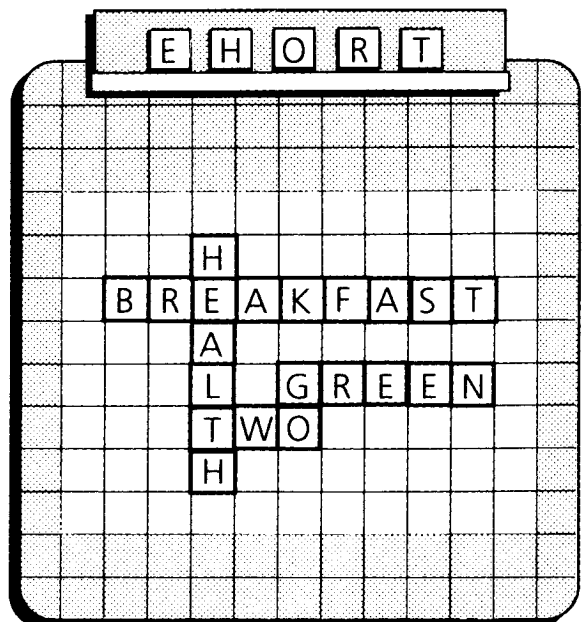

# Beatles Crossword

Between 1962 and 1970, The Beatles wrote and recorded 184 songs. The titles of 26 of those songs are the clues for this crossword.

## ACROSS

- 5 I saw her standing **there**
- 6 Here **comes** the sun
- 10 Good morning good **morning**
- 11 The fool **on** the hill
- 12 P.S I **love** you
- 13 **Yes**, it is
- 16 When I'm **sixty-four**
- 18 Here, there and everywhere
- 20 **She's** a woman
- 22 All you need **is** love
- 23 With a little help from my **friends**
- 24 **Love** my life

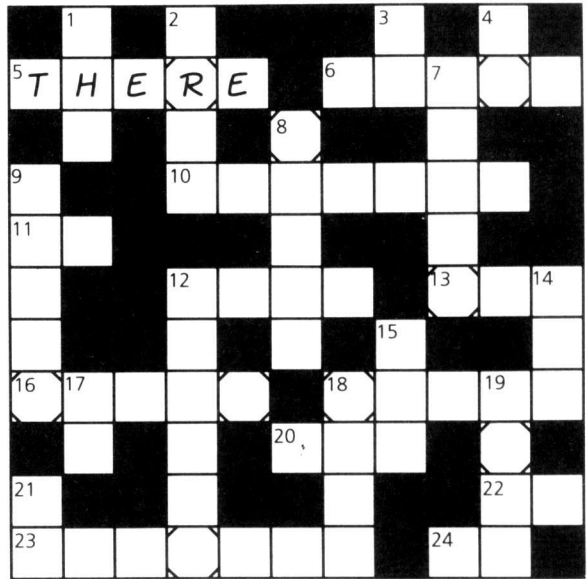

## DOWN

- 1 Across **the** universe
- 2 **From** me to you
- 3 I want **to** hold your hand
- 4 Tell **me** why
- 7 You never give me your **money**
- 8 **Drive** my car
- 9 She **loves** you
- 12 Hello, **little** girl
- 14 **She** came in through the bathroom window
- 15 Back in **the** U.S.S.R.
- 17 Let **it** be
- 18 **My** boy
- 19 **Ram**
- 21 The ballad **of** John and Yoko



## One more song!

Take the letters from the special squares:  and put them in the correct order to make the title of another song by The Beatles. It's just one word.

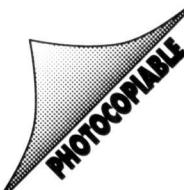



# Rhyming pairs

Six of the words in the box are incomplete. Complete them with the help of the pictures. Then put the twenty-four words into twelve rhyming pairs.

For example:



A collection of word cards and puzzle pieces. Some cards are incomplete and have dashed lines for missing letters. Some puzzle pieces are crossed out with an 'X'.

- Words: rude, note, s --, good, those, ~~great~~, her, food, eat, where, were, ~~wait~~, flute, me, sky, rose, my, c ---, - a ---, --- t, wood, whose

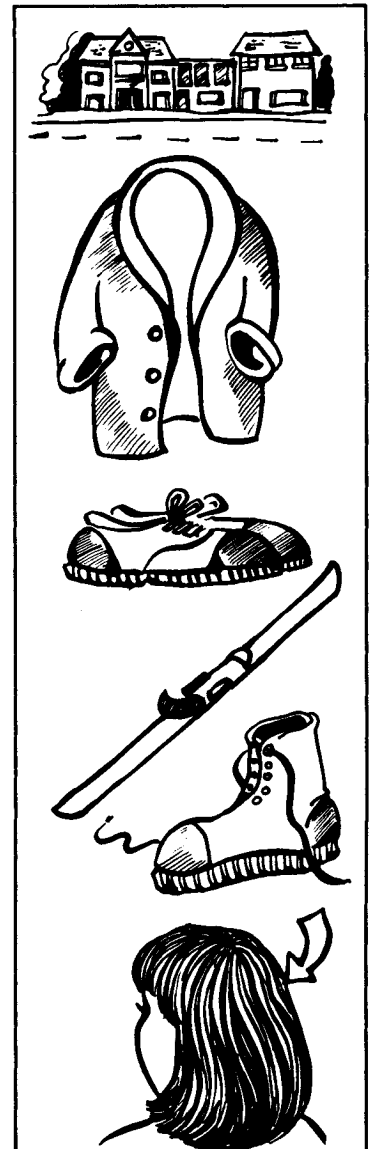

great	wait		

# Words and PICTURES

Put these words into the correct pictures.

No, thanks. Have you got any lemonade?

Here you are. One coffee and two lemonades.

Would you like some coffee?

What would you like?

Strontium is a metal.

No, thanks. I never drink beer.

A beer, please.

I think this door is made of metal.

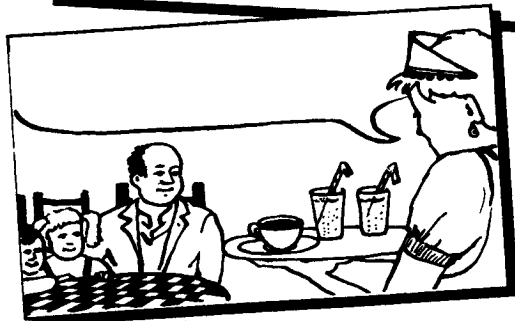
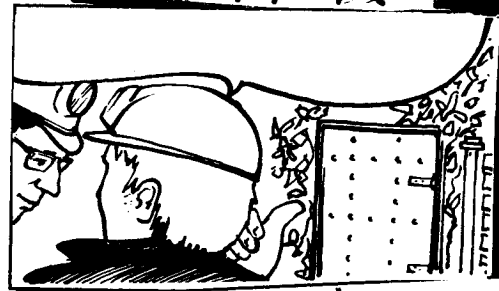
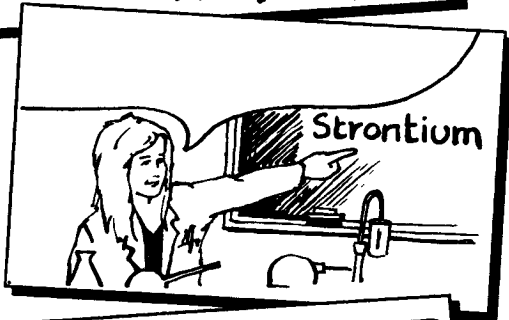

Group 1

Group 2

Question:

Can you see a reason why the pictures are in two groups?

# Famous names

Look at the groups of famous names. In each group, three people are of the same nationality and one person is of a different nationality.

Write the nationality of the three people in Grid A, and the nationality of the other person in Grid B.

(If you have a problem, you can find all the nationalities at the bottom of the page).

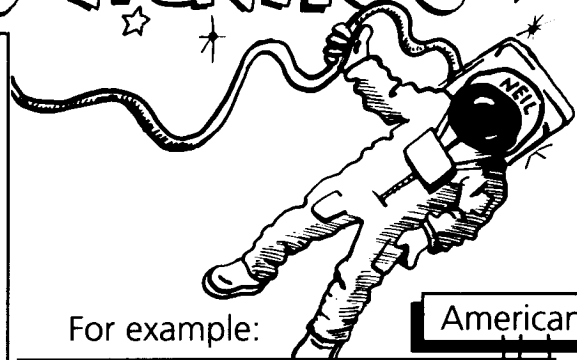

For example:

- 1 **Neil Armstrong**, astronaut
- Walt Disney**, film-maker
- William Shakespeare**, writer
- Frank Sinatra**, singer

American

English

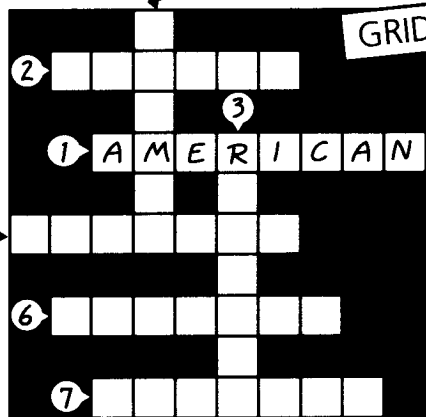

GRID A

- 2 **Brigitte Bardot**, actress
- Mahatma Gandhi**, political leader
- Victor Hugo**, writer
- Jean-Paul Sartre**, philosopher

- 3 **Pyotr Tchaikovsky**, composer
- Valentina Tereshkova**, astronaut
- Wolfgang Amadeus Mozart**, composer
- Alexander Solzhenitsyn**, writer

- 5 **Confucius**, philosopher
- Mao Tse-Tung**, political leader
- Akira Kurosawa**, film-maker
- Lao-Tze**, philosopher

- 4 **Johann Sebastian Bach**, composer
- Johann Wolfgang von Goethe**, writer
- Ludwig van Beethoven**, composer
- Vincent van Gogh**, painter

- 6 **Federico Fellini**, film-maker
- Sophia Loren**, actress
- Leonardo da Vinci**, scientist and artist
- Melina Mercouri**, actress and politician

- 7 **Andrés Segovia**, guitarist
- Fidel Castro**, political leader
- Miguel de Cervantes**, writer
- Pablo Picasso**, painter

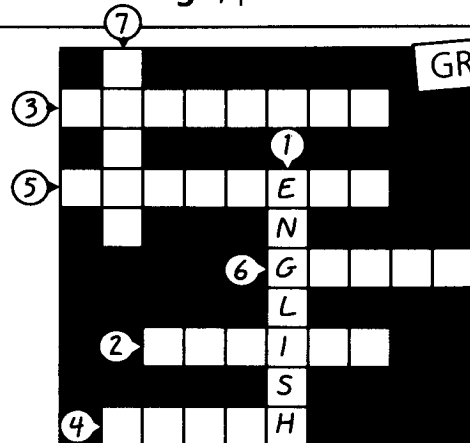

GRID B

American - Austrian - Chinese - Cuban - Dutch - English - French  
German - Greek - Indian - Italian - Japanese - Russian - Spanish

# Take them away

Look at these twenty-eight matches:

If you take away seven matches, you find this word:

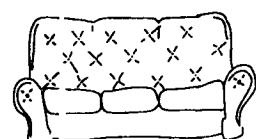
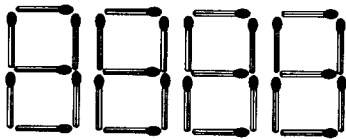

Find the words in the boxes below. For each word, write how many matches you take away. (The total number is sixty-eight).

①

Take away seven.

CUP

②

Take away \_\_\_\_\_

③

Take away \_\_\_\_\_

④

Take away \_\_\_\_\_

⑤

Take away \_\_\_\_\_

⑥

Take away \_\_\_\_\_

⑦

Take away \_\_\_\_\_

⑧

Take away \_\_\_\_\_

# From time to time



Two pieces of this jigsaw are already in position. Add the four others ( just look at the shapes of the pieces -don't worry about the letters for the moment ).

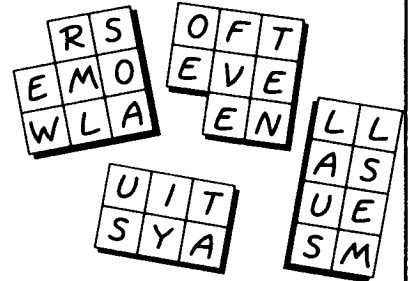
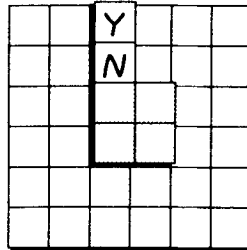

Go round the jigsaw like this:

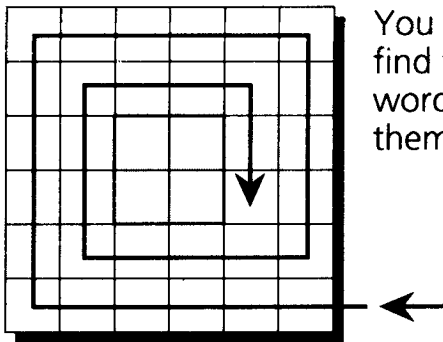

You should find five words. Write them here:



One of those five words is missing from this proverb, song title and film title (the same word in all three places). Which word is it?

**Proverb**

The customer is \_\_\_\_\_ right.

**Song**

You \_\_\_\_\_ hurt the one you love.

**Film**

The postman \_\_\_\_\_ rings twice.



Which word is missing from this proverb, song title and film title?

**Proverb**

Better late than \_\_\_\_\_.

**Song**

I \_\_\_\_\_ go out in the rain.

**Film**

\_\_\_\_\_ look back.

# Find the Families

## Family 1

This family of words has four members: 'THIS' is the first. What are the three others? Like 'THIS', each is hidden in the name of a writer. Can you find them?

1 CHRISTOPHER ISHERWOOD

2 AGATHA CHRISTIE

3 KATHERINE MANSFIELD

4 ARTHUR KOESTLER

1 THIS

2

3

4

## Family 2

This family of words has seven members: 'ME' is the first. What are the others? Like 'ME', each is hidden in the name of a United Nations state.

1 ZIMBABWE

2 BYELORUSSIA

3 THE UNITED KINGDOM

4 THE REPUBLIC OF IRELAND

5 PAKISTAN

6 TUNISIA

7 THE BAHAMAS

1 ME

2

3

4

5

6

7



# WHICH MEDICINE?

These six people are not very well - each has a different problem. Decide which medicine is best for each person: the letters on the pills spell the problems.

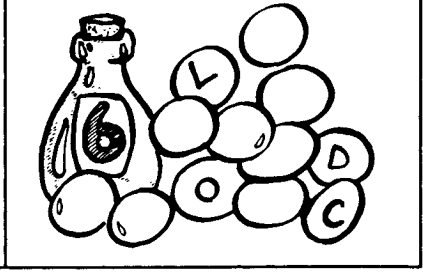
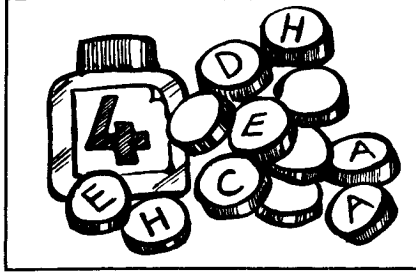
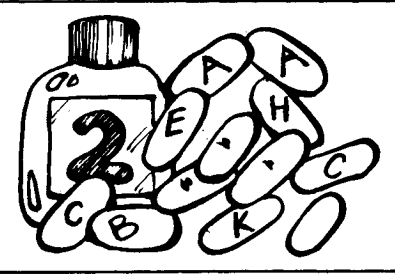
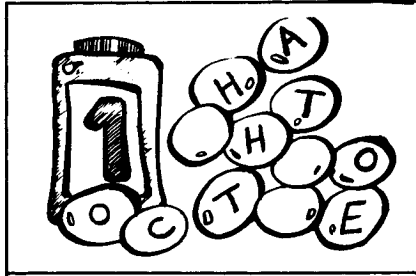

- A has got a  , so Number  is the best medicine.
- B has got a  , so Number  is the best medicine.
- C has got a  , so Number  is the best medicine.
- D has got a  , so Number  is the best medicine.
- E has got a  , so Number  is the best medicine.
- F has got a  , so Number  is the best medicine.

# Song titles

At the bottom of the page, there is an alphabetical list of eleven song titles. Complete the titles by using these verbs, in their *-ing* form:

BREAK	CRY
DO	DANCE
FALL	WAIT
LAUGH	TALK
WALK	LOOK
RAIN	

And... Find the correct picture for each song, and put the numbers in the circles.



8	E	V	E	R	Y	B	O	D	'	S	L	A	U	G	H	I	N	G	PHIL FEARON 1984		
	E	V	E	R	Y	B	O	D	'	S									NILSSON 1969		
	I	'	M																ANIMALS 1964		
	I	'	M																BLUEBELLS 1984		
	I	'	M	S	T	I	L	L											DIANA ROSS 1971		
	I	'	M						B	E	H	I	N	D	Y	O	U			EDDIE FISHER 1953	
	I	T	'	S															DARTS 1978		
	J	O	H	N,	I	'	M	O	N	L	Y								DAVID BOWIE 1972		
	S	O	M	E	O	N	E	'	S							A	T	Y	O	U	BOOMTOWN RATS 1980
	W	H	A	T	A	R	E	Y	O	U					S	U	N	D	A	Y?	DAWN 1971
	Y	O	'	R	E									M	Y	H	E	A	R	T	KEELY SMITH 1965

Question:

One of the songs is not about the present: It's about the *future*. Which one?

# A chemical code

Here are some chemical elements and their symbols:

Aluminium	Al	Copper	Cu	Iron	Fe	Oxygen	O
Calcium	Ca	Fluorine	F	Neon	Ne	Phosphorus	P
Carbon	C	Hydrogen	H	Nickel	Ni	Potassium	K
Chlorine	Cl	Iodine	I	Nitrogen	N	Sulphur	S
Cobalt	Co						

Use the symbols to do this crossword. (All the answers are in the picture.)

**Across**

1 Calcium + Sulphur + Hydrogen.  
 3 Cobalt + Neon.  
 4 Copper + Phosphorus.  
 5 Carbon + Hydrogen + Aluminium + Potassium.  
 7 Calcium + Nitrogen + Aluminium.  
 10 Fluorine + Iodine + Sulphur + Hydrogen.  
 11 Calcium + Iron.

**Down**

1 Calcium + Phosphorus.  
 2 Cobalt + Oxygen + Potassium.  
 4 Chlorine + Oxygen + Carbon + Potassium.  
 6 Hydrogen + Aluminium + Fluorine.  
 8 Nickel + Neon.  
 9 Sulphur + Hydrogen + Iodine + Phosphorus.

# BOTTOM HALF ONLY

Complete the words and pictures by adding the top half of each one.  
Draw a line from each word to the correct picture.

**TOWEL**

**TOOTHBRUSH**

**TOOTH**

**TOOTH**

**TOOTH**

**TOOTH PASTE**

**BATH**

**SHAMPOO**

**MIRROR**

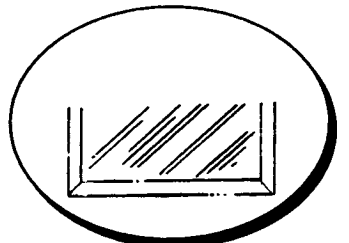
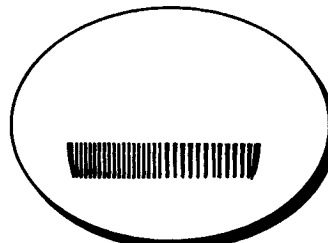
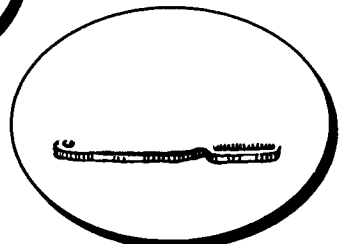
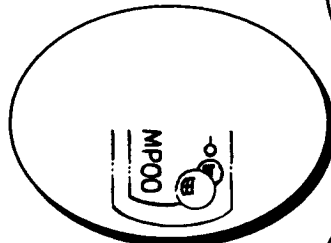
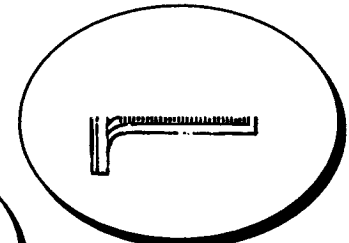
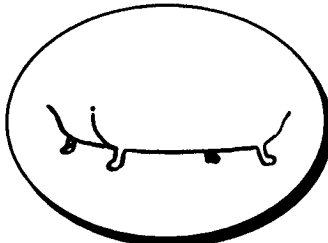
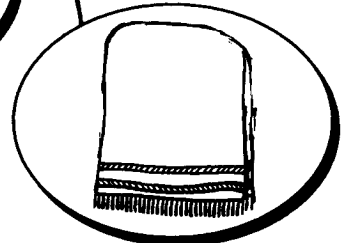
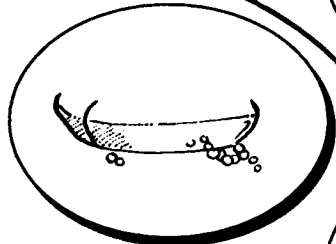
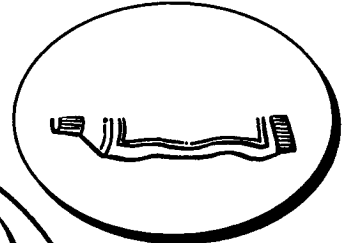

Question:

In which room could you find those things? Complete the word:

**BATHROOM**

# CROSSWORD IN TWO PARTS

In each clue, the missing word is the answer.

## Across

4 THIS IS THE .....

5 WOULD YOU LIKE ..... CLIP OF TEA?

8 MONDAY  
TUESDAY  
WEDNESDAY  
FRIDAY

9 THIS SHOP SELLS .....

10 tall → short  
fat → .....

12 ..... VIRGINIA  
..... CAROLINA  
SOUTH CAROLINA

15 THIS BAG ISN'T MADE OF PLASTIC. IT'S MADE OF .....

16 YOU ..... YOU VERY MUCH.  
..... YOU'RE WELCOME.

17 WHAT'S THE ..... LIKE?  
IT'S RAINING.

## Down

1 THIS ISN'T A CINEMA. IT'S A .....

2 IS THIS YOUR ..... BRUSH?

3 I'VE GOT ONE SISTER AND TWO .....

4 I'M EIGHTEEN TODAY.  
HAPPY .....!

6 IS ..... A SUPERMARKET IN THIS STREET?

7 THANKS. I WAS REALLY .....

11 MR. AND MRS. SMITH AND ..... DAUGHTER ALICE.

13 ENGLAND IS BIGGER ..... WALES.

14 WHAT'S ..... TIME?  
SIX THIRTY.

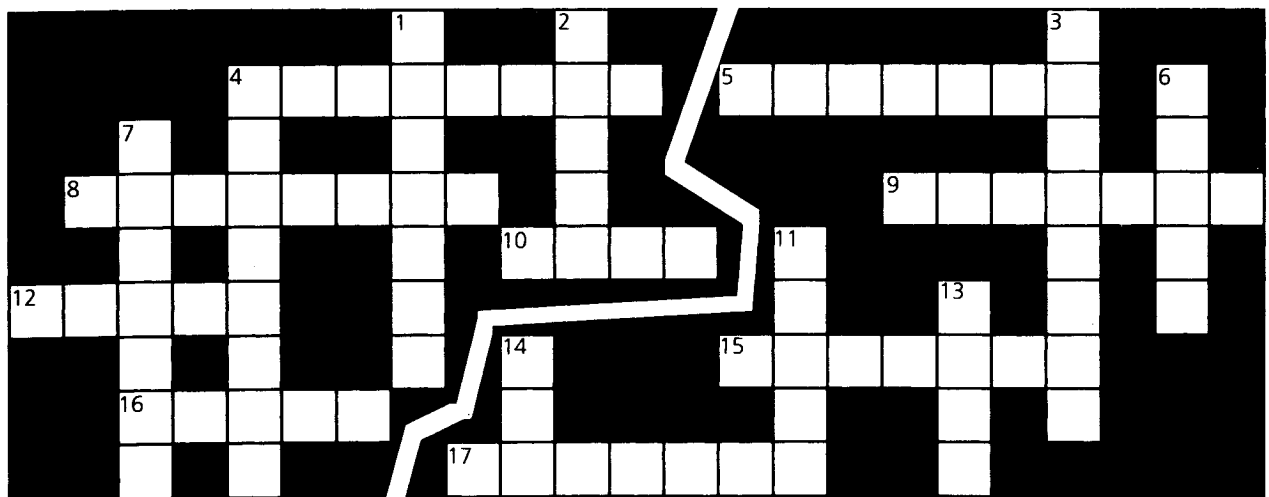

Question:

The crossword is divided into two parts. Why? (If you read aloud the words in each part, you can hear the reason.)

# Road signs

First, colour the twelve British road signs:

A = red      B = black      C = blue      D = yellow

Then read the meanings and put the numbers in the correct places.

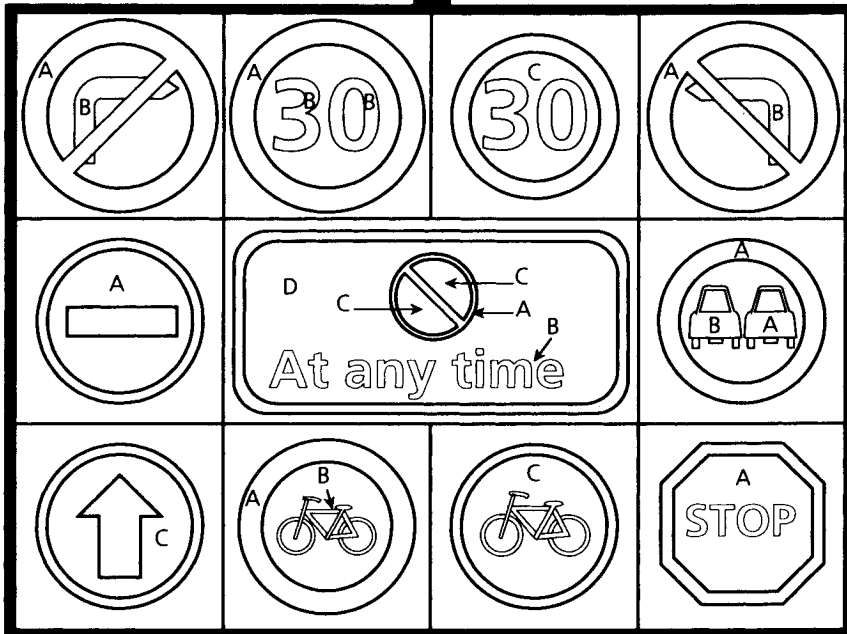

- 1 You've got to stop here.
- 2 You can't enter this street.
- 3 You've got to drive faster than thirty miles per hour here: 30 m.p.h. is the *minimum* speed.
- 4 You can't travel by bicycle here.
- 5 You can't turn right here.
- 6 You can only travel by bicycle here.
- 7 You can't turn left here.
- 8 You've got to go straight on here: you can't turn left or right.
- 9 You can't overtake here.
- 10 You can never park here.
- 11 You can't drive faster than thirty miles per hour here: 30 m.p.h. is the *maximum* speed.

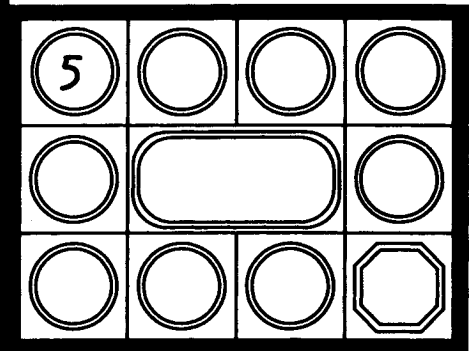

# Eye test

On each eye test chart, there are the letters of two words.  
With the help of the pictures, find the words and write  
them on the backs of the chairs.

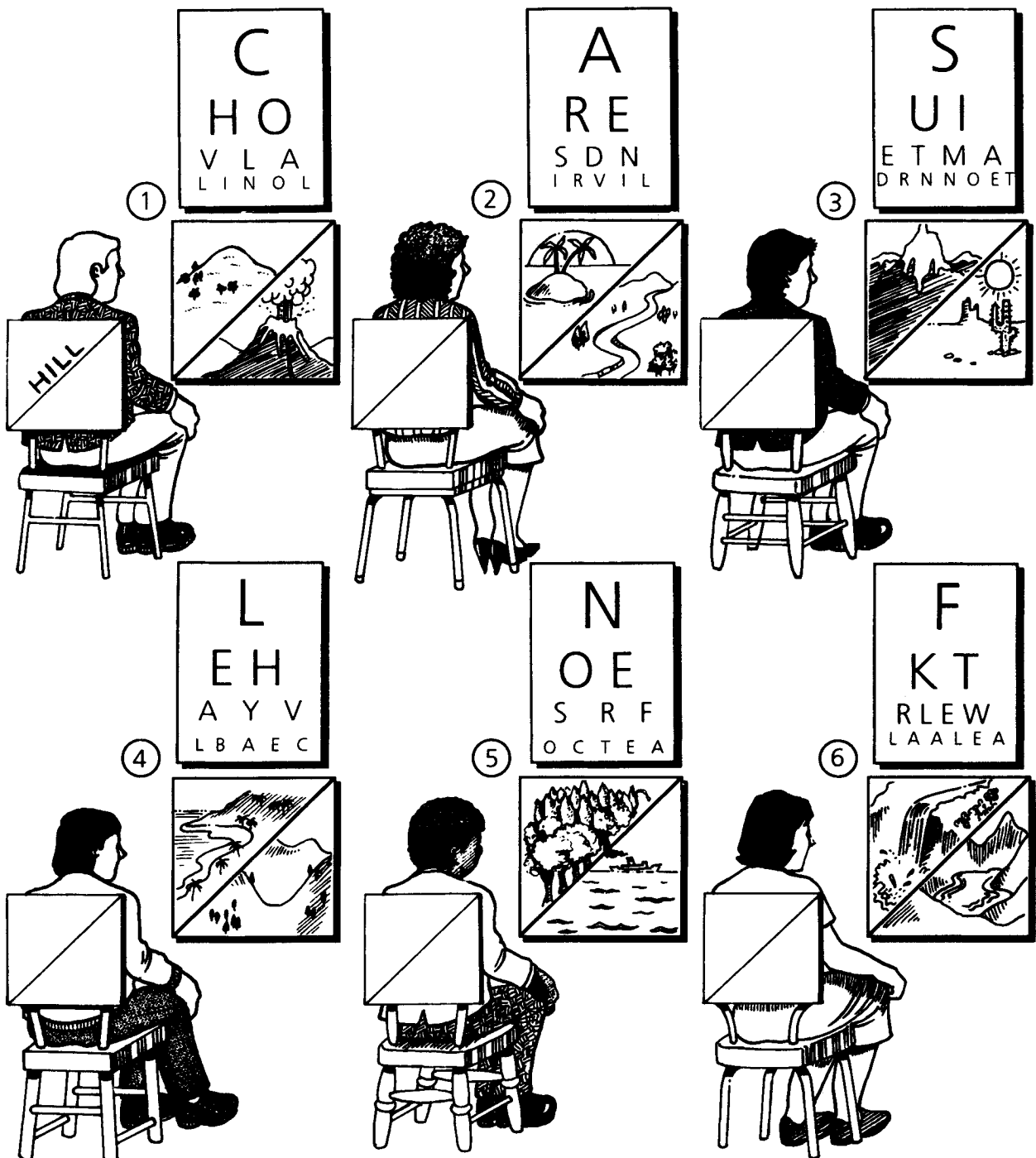











# Holiday photos

Use these words to complete the titles for the photos:

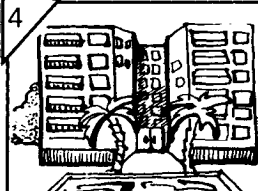
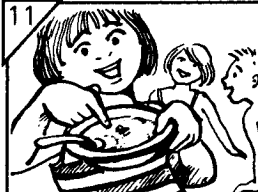
- THEIR
- THERE
- WERE
- WHERE
- HER
- HERE
- IT'S
- IT'S
- THAN
- THAT
- OF
- OFF
- WHO'S
- WHOSE

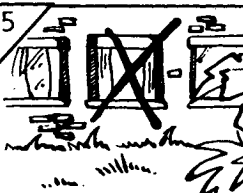
- 3 TOM AND SUE, GETTING OFF THE PLANE.
- IT WAS HOTTER \_\_\_\_\_ LONDON!
- THE FRONT \_\_\_\_\_ OUR HOTEL.
- OUR ROOM WAS \_\_\_\_\_
- THE OLD TOWN, WITH \_\_\_\_\_ NARROW STREETS.
- A CASTLE \_\_\_\_\_ WE VISITED.
- SUE AND \_\_\_\_\_ FRIEND MARIA.
- THE BEACH \_\_\_\_\_ WE WENT SWIMMING.
- TOM AND JILL, WITH \_\_\_\_\_ FRIEND MANUEL.
- \_\_\_\_\_ THIS?
- \_\_\_\_\_ FEET ARE THESE?
- THE ICE-CREAMS \_\_\_\_\_ DELICIOUS!
- \_\_\_\_\_ SIESTA TIME!
- WAITER, \_\_\_\_\_ IS A FLY IN MY SOUP!

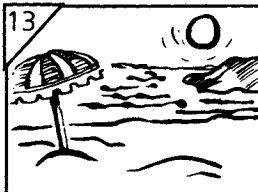
Put the correct number beside each title.

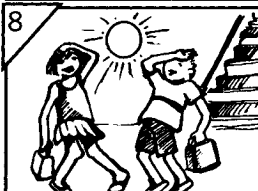
1 	2 	9 	10 
3 	4 	11 	12 
5 	6 	13 	14 
7 	8 		



# Saying the wrong thing

The speakers in these pictures are all saying the wrong thing:

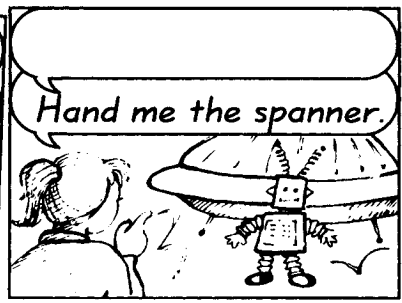
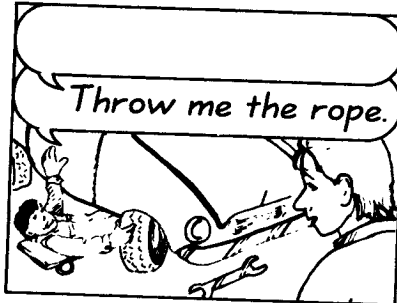
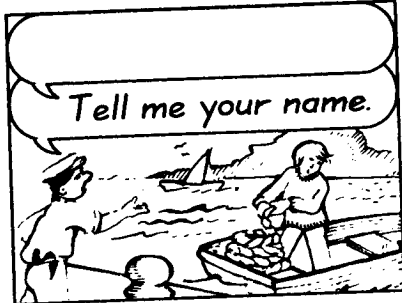

Now they are all saying the right thing:

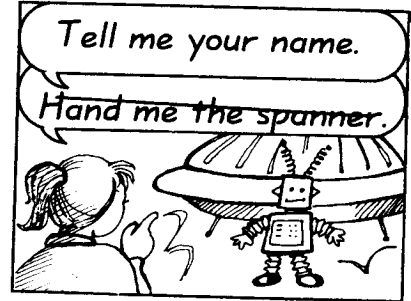
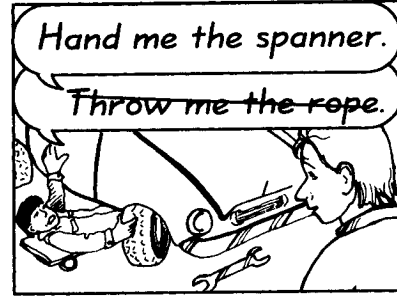
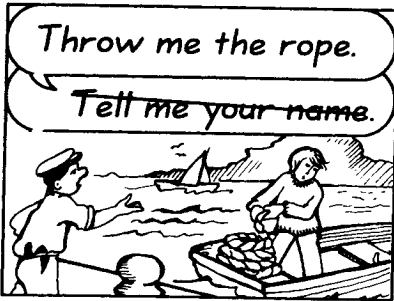

Here are eight more pictures with speakers saying the wrong thing. Move the sentences so that they are all saying the right thing.

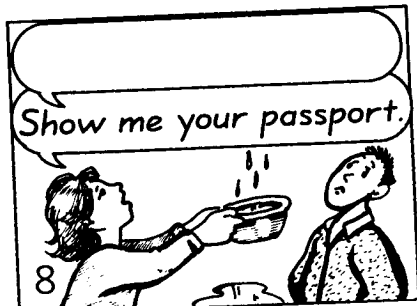
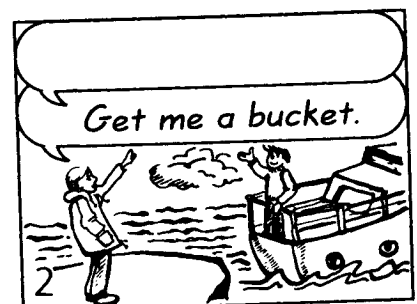
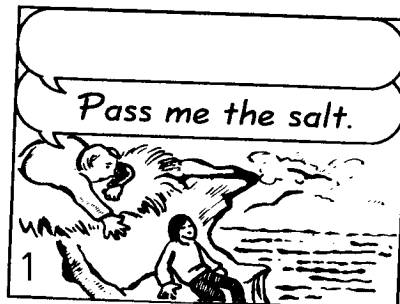

# Heavy syllables

Read these words aloud:

**UNDER**    **BETWEEN**

Both words have two syllables (UN-DER, BE-TWEEN), but the *stress* is different.

In **UNDER**, the stress is on the first syllable: the first syllable is 'heavier'.



In **BETWEEN**, the stress is on the second syllable: the second syllable is 'heavier'.



Here are twelve more words. Put them onto the correct scales.

There are six like this:



and six like this:

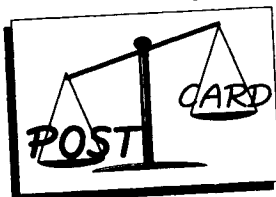
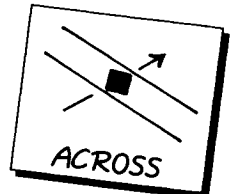
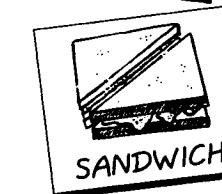
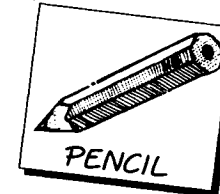
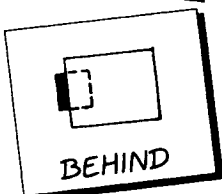
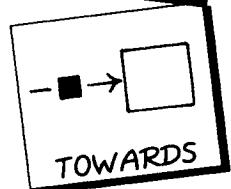
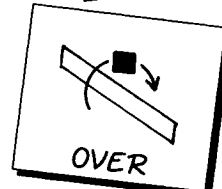
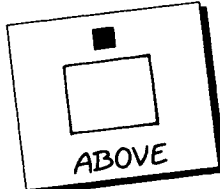
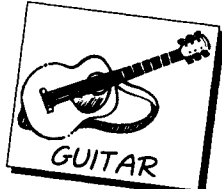
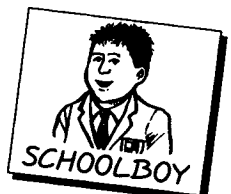
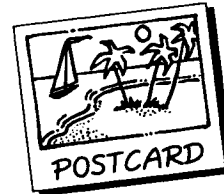

# What are their jobs ?

Each of the names is an anagram of a job. For example:

C. TROOD = DOCTOR

Find the other jobs, and add the correct numbers from the pictures.



8	C. TROOD DOCTOR
	C.R. Roeg
	Pat Rine
	Gena N. West
	R. Coat
	C. HUBERT
	IAN. T. CIPOLI
	Harris S. Reed
	K. BEAR
	T.D. Stein
	E.E. CHART
	G. Rinse
	Lisa J. Troun
	T. I. INSECTS

# COMPLETE THE TITLES

A lot of English words end with the letters 'er'. Here are twelve. Use them to complete the film titles on the posters.

- HIGHER
- ALEXANDER
- CORNER
- LETTER
- PANTHER
- SWIMMER
- CHRISTOPHER
- WALTER
- DRIVER
- BIGGER
- SINGER
- GREENER

<p>1</p> <p>The Grass is</p> <div style="border: 1px solid black; height: 40px; width: 100%;"></div>	<p>4</p> <p>The Jazz</p> <div style="border: 1px solid black; height: 40px; width: 100%;"></div>	<p>7</p> <p>HARRY AND</p> <div style="border: 1px solid black; height: 40px; width: 100%;"></div> <p>GO TO NEW YORK</p>	<p>10</p> <p>DANGEROUS</p> <div style="border: 1px solid black; height: 40px; width: 100%;"></div>
<p>2</p> <div style="border: 1px solid black; height: 40px; width: 100%;"></div> <p>THAN LIFE</p>	<p>5</p> <p>THE</p> <div style="border: 1px solid black; height: 40px; width: 100%;"></div>	<p>8</p> <div style="border: 1px solid black; height: 40px; width: 100%;"></div> <p>COLUMBUS</p>	<p>11</p> <p>The Pink</p> <div style="border: 1px solid black; height: 40px; width: 100%;"></div>
<p>3</p> <p>HIGHER AND</p> <div style="border: 1px solid black; height: 40px; width: 100%;"></div>	<p>6</p> <p>TAXI</p> <div style="border: 1px solid black; height: 40px; width: 100%;"></div>	<p>9</p> <div style="border: 1px solid black; height: 40px; width: 100%;"></div> <p>the Great</p>	<p>12</p> <p>A</p> <div style="border: 1px solid black; height: 40px; width: 100%;"></div> <p>TO BREZHNEV</p>

Question:

Why are the posters in groups of three?

# **ENGLISH PUZZLES-2**

## **ANSWERS**

# Solutions

## Top Half Only

Page 7

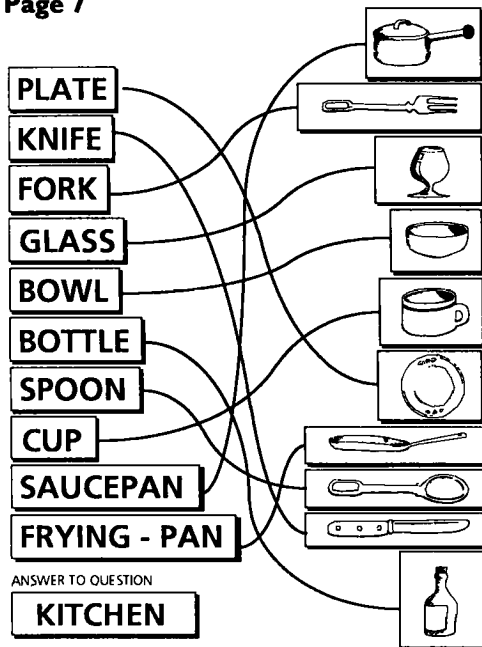

## What's on the Menu?

Page 10

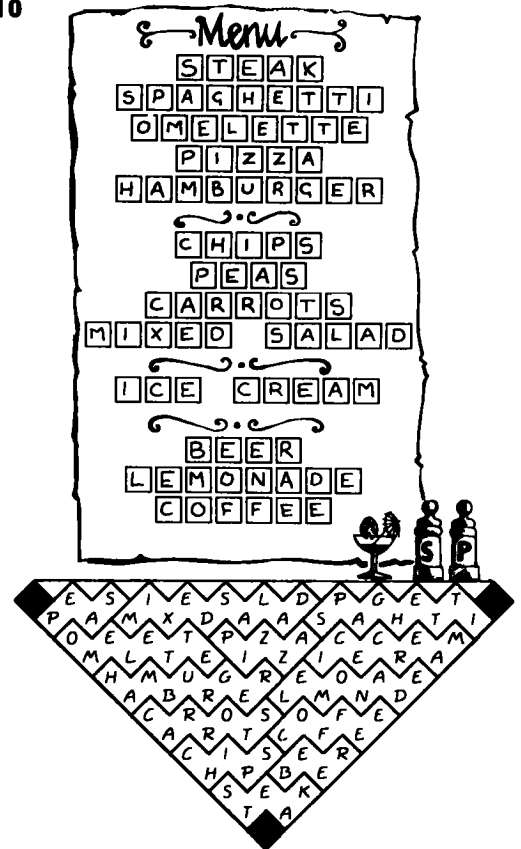

## Well Played!

Page 8



- ①
- |            |
|------------|
| MARVELLOUS |
| WONDERFUL  |
| TERRIBLE   |
| EXCELLENT  |
| TERRIFIC   |
| FANTASTIC  |
- The word meaning 'bad' is *terrible*. All the other words - including *terrific* - mean 'good'.

- ②
- The word meaning 'very interesting' is *FASCINATING*.  
The word meaning 'not interesting' is *BORING*.

## People and Things

Page 9

The eleven titles go into these three boxes (the other boxes are empty):

 SHE KNEW ALL THE ANSWERS HE WALKED BY NIGHT HE RAN ALL THE WAY WHO WAS THAT LADY? WHO IS HARRY KELLERMAN?	 IT CAME FROM OUTER SPACE IT CAME FROM BENEATH THE SEA IT!
---	--

 THEY CAME BY NIGHT THEY CAME TO A CITY THEM!
---

In the first box, these films are about a man: 'He walked by night', 'He ran all the way', 'Who is Harry Kellerman?' These films are about a woman: 'She knew all the answers', 'Who was that lady?'

## Strange Pictures

Page 11

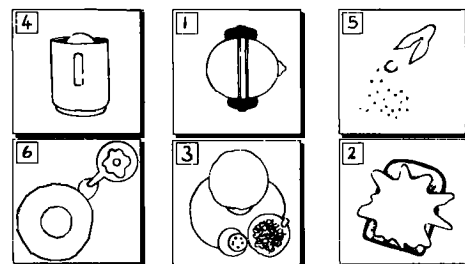

giraffe window man piece policeman cup cowboy egg COUNTABLE	hair music bread butter spaghetti lemonade tea sugar snow UNCOUNTABLE
---	--

## Letters into Words

Page 12

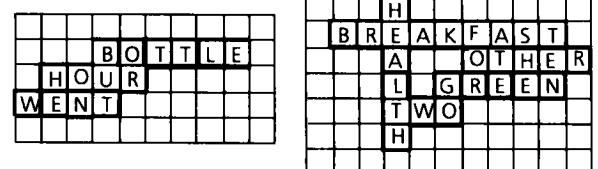

The four new words are: HOUR, HE, ON and OR.  
The five new words are: OTHER, FOR, ATE (the past tense of eat), SHE and TEN.

# Beatles Crossword

Page 13

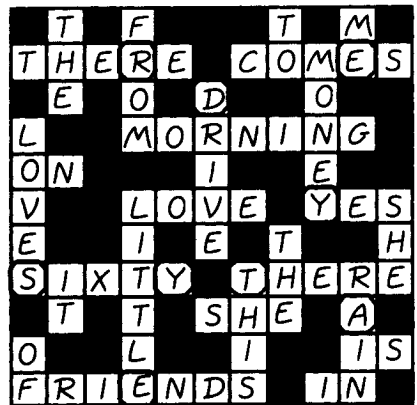

One more song:



# Rhyming Pairs

Page 14

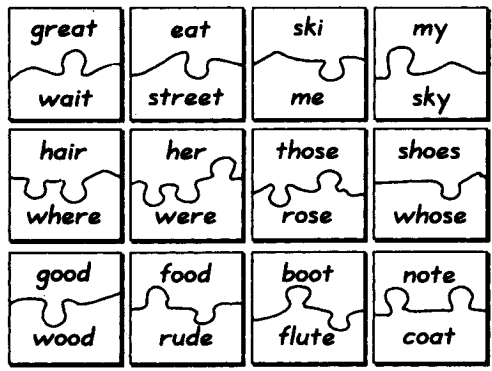

# Words and Pictures

Page 15

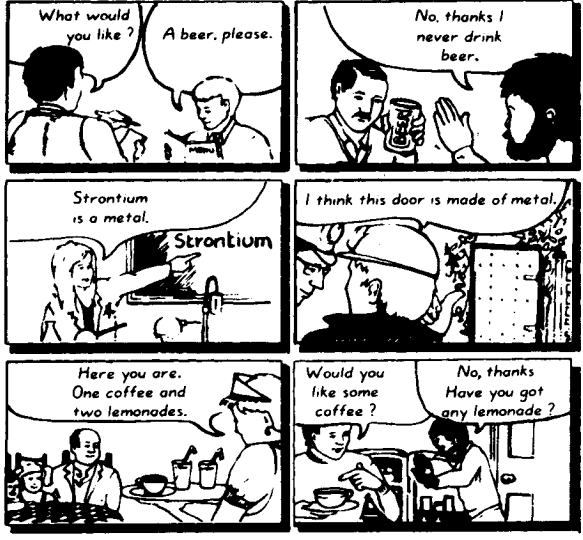

Remember: A lot of nouns can be countable and uncountable. In the first group of pictures, the nouns, 'beer', 'metal', 'coffee' and 'lemonade' are countable; in the second group of pictures, they are uncountable.

# Famous Names

Page 16

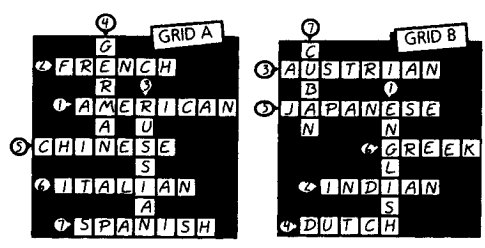

# Take Them Away

Page 17

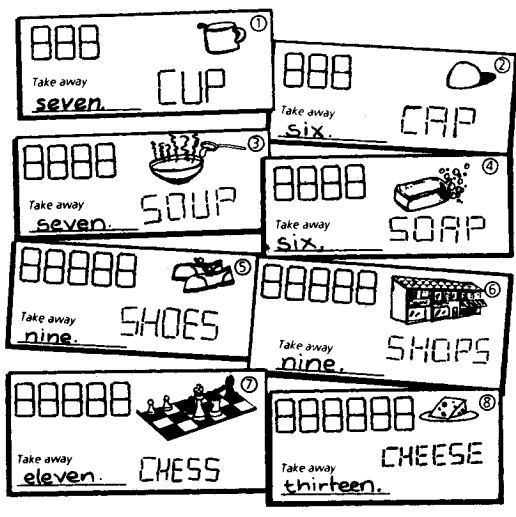

# From Time to Time

Page 18

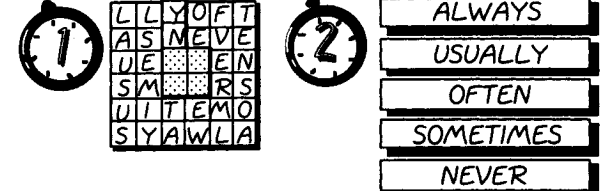

- 3 Proverb: The customer is always right. Song: You always hurt the one you love. Film: The postman always rings twice.
- 4 Proverb: Better late than never. Song: I never go out in the rain. Film: Never look back.

# Find the Families

Page 19

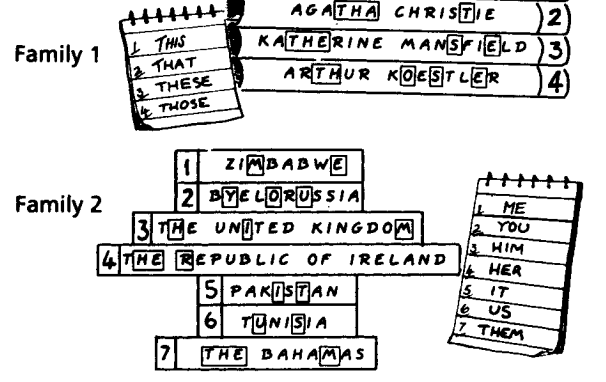

# Beatles Crossword

Page 13

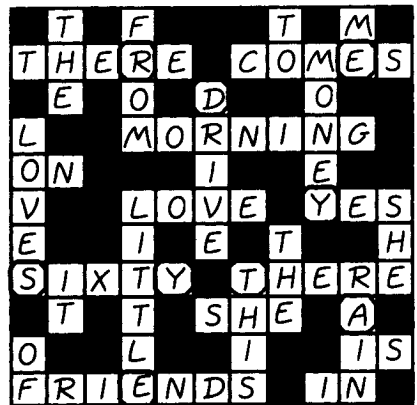

One more song:



# Rhyming Pairs

Page 14

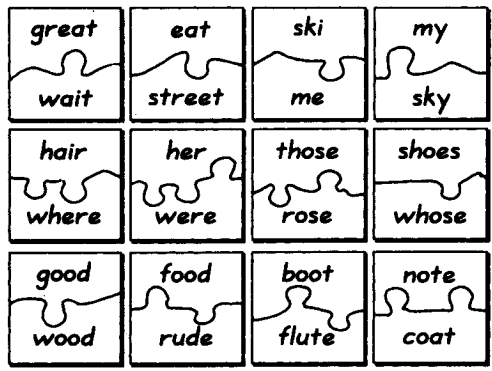

# Words and Pictures

Page 15

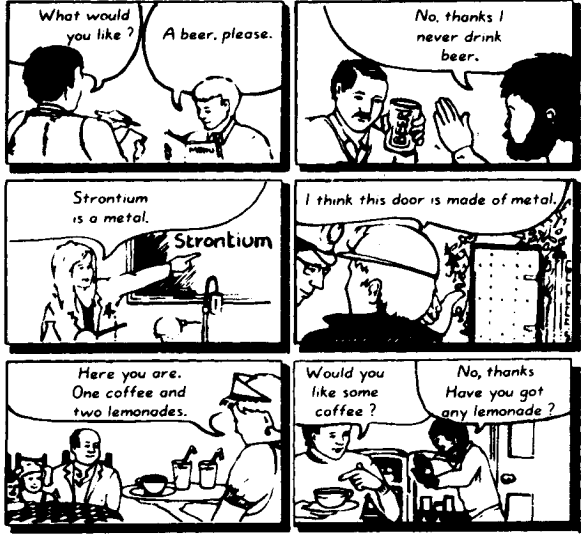

Remember: A lot of nouns can be countable and uncountable. In the first group of pictures, the nouns, 'beer', 'metal', 'coffee' and 'lemonade' are countable; in the second group of pictures, they are uncountable.

# Famous Names

Page 16

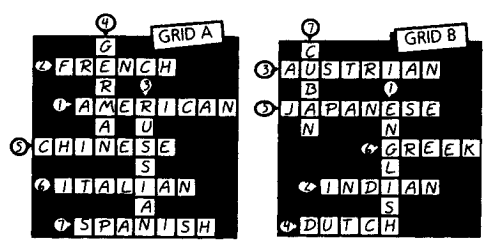

# Take Them Away

Page 17

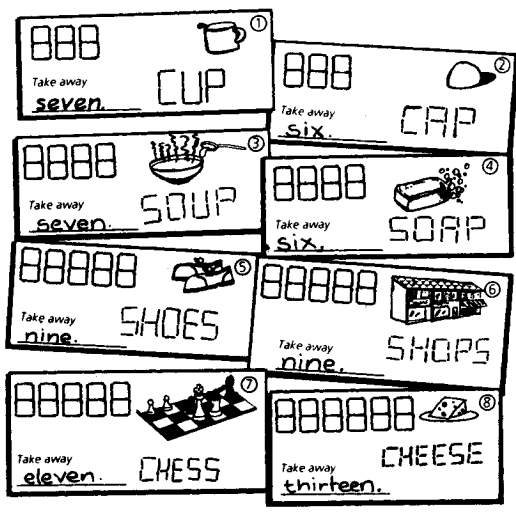

# From Time to Time

Page 18

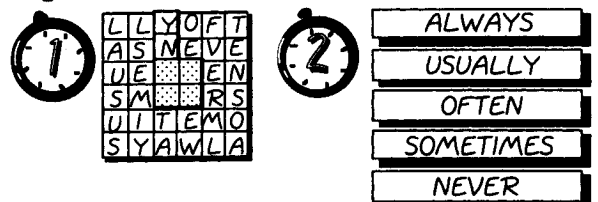

- 3 Proverb: The customer is always right. Song: You always hurt the one you love. Film: The postman always rings twice.
- 4 Proverb: Better late than never. Song: I never go out in the rain. Film: Never look back.

# Find the Families

Page 19

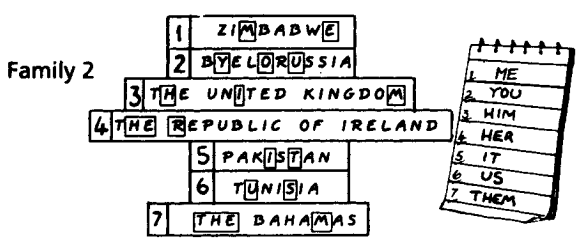



## Which Medicine?

Page 20

- A has got a HEADACHE, so Number 4 is the best medicine.
- B has got a COLD, so Number 6 is the best medicine.
- C has got a TOOTHACHE, so Number 1 is the best medicine.
- D has got a STOMACHACHE, so Number 3 is the best medicine.
- E has got a COUGH, so Number 5 is the best medicine.
- F has got a BACKACHE, so Number 2 is the best medicine.

Remember: it is also possible to say 'toothache', 'stomachache' and 'backache' without 'a' ('I've got toothache', etc.).

## Song Titles

Page 21

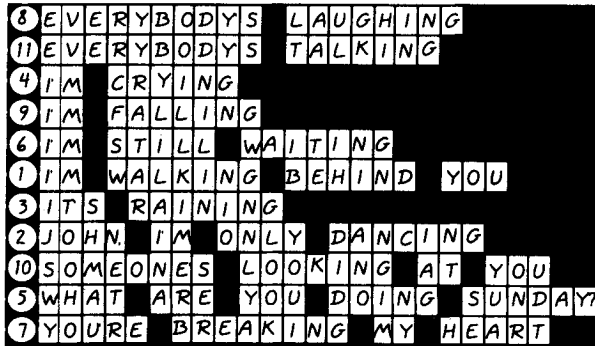

Remember: the *-ing* form of 'dance' is 'dancing' (not 'dancing').  
The song about the future is 'What are you doing Sunday?' (You can also say 'What are you doing on Sunday?')

## A Chemical Code

Page 22

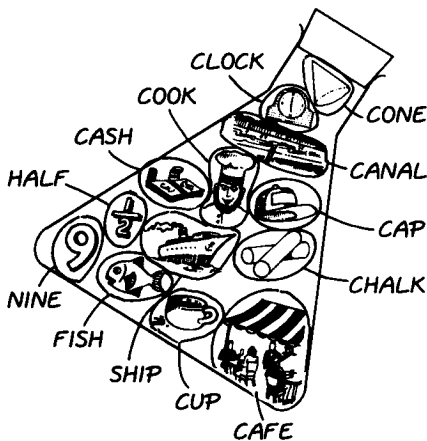

## Bottom Half Only

Page 23

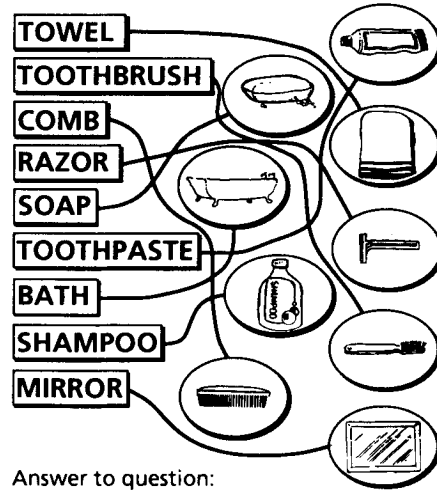

Answer to question:

**BATHROOM**

## Crossword in Two Parts

Page 24



All the words include the letters TH. In the first part of the crossword, the pronunciation is 'soft', /θ/; in the second part of the crossword, the pronunciation is 'hard', /ð/.

## Road Signs

Page 25

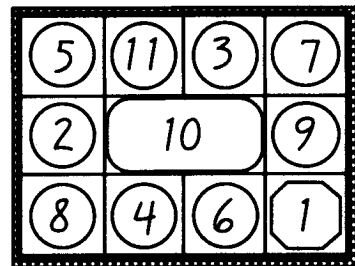

## Eye Test

Page 26

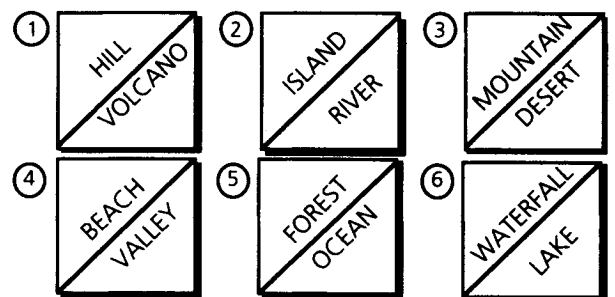

# Holiday Photos

Page 27

3	TOM AND SUE, GETTING <b>OFF</b> THE PLANE.
8	IT WAS HOTTER <b>THAN</b> LONDON !
4	THE FRONT <b>OF</b> OUR HOTEL.
5	OUR ROOM WAS <b>HERE</b> .
12	THE OLD TOWN, WITH <b>ITS</b> NARROW STREETS.
1	A CASTLE <b>THAT</b> WE VISITED.
2	SUE AND <b>HER</b> FRIEND MARIA.
13	THE BEACH <b>WHERE</b> WE WENT SWIMMING.
10	TOM AND JILL, WITH <b>THEIR</b> FRIEND MANUEL.
6	<b>WHOS</b> THIS?
9	<b>WHOSE</b> FEET ARE THESE?
7	THE ICE-CREAMS <b>WERE</b> DELICIOUS!
14	<b>ITS</b> SIESTA TIME!
11	WAITER, <b>THERE</b> IS A FLY IN MY SOUP!*

• This is the first line of a lot of jokes. For example:  
 Waiter, there's a fly in my soup!  
 – Don't speak too loud, sir. I haven't got one for everybody.  
 Waiter, there's a fly in my soup!  
 – I'm sorry, madam. Are you a vegetarian?

# Saying the Wrong Thing

Page 28

- ① Give me your hand
- ② Send me a postcard.
- ③ Show me your passport
- ④ Draw me a map.
- ⑤ Read me a story.
- ⑥ Play me a song.
- ⑦ Pass me the salt.
- ⑧ Get me a bucket.

# Heavy Syllables

Page 29

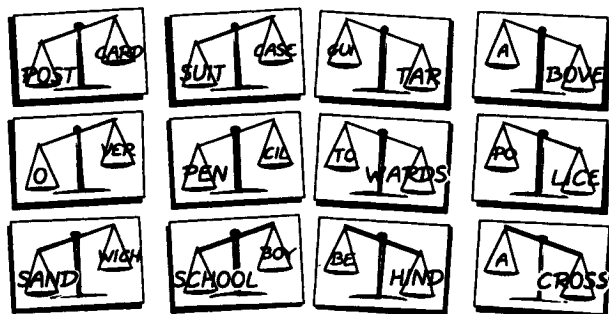

# What Are Their Jobs?

Page 30

8	C. TROOD DOCTOR	4	Harris S. Reed HAIRDRESSER
10	C.R. Roeg GROCER	13	K. BEAR BAKER
5	Pat Rine PAINTER	11	T.D. Stein DENTIST
14	Gena N. West NEWSAGENT	3	E.E. CHART TEACHER
6	R. Coat ACTOR	9	G. Rinse SINGER
12	C. HUBERT BUTCHER	2	Lisa J. Traun JOURNALIST
1	IAN. T. CIPOLI POLITICIAN	7	T. I. INSECTS SCIENTIST

# Complete the Titles

Page 31

1. The grass is greener.
2. Bigger than life.
3. Higher and higher.
4. The jazz singer.
5. The swimmer.
6. Taxi driver.
7. Harry and Walter go to New York.
8. Christopher Columbus.
9. Alexander the Great.
10. Dangerous corner.
11. The Pink Panther.
12. A letter to Brezhnev.

Answer to question:

In the first group, 'greener', 'bigger' and 'higher' are all comparatives.

In the second group, 'singer', 'swimmer' and 'driver' all come from verbs ('sing', 'swim', 'drive').

In the third group, 'Walter', 'Christopher' and 'Alexander' are all names.

The words in the fourth group ('corner', 'panther' and 'letter') can't go into the other groups.

# The United States

Page 32

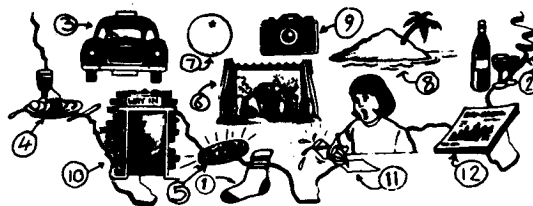
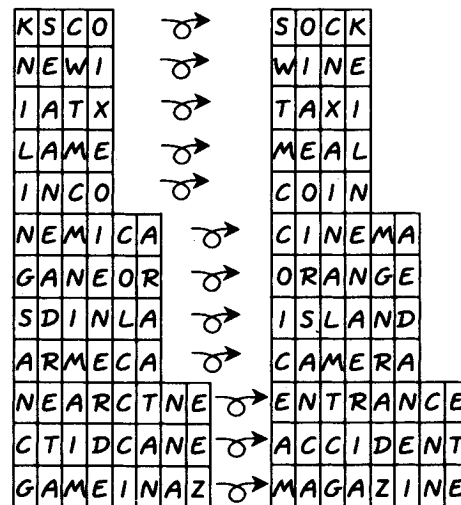

# Dominoes

Page 33

- 1 CHESES
- 2 STAMP-COLLECTING
- 3 FISHING
- 4 PHOTOGRAPHY
- 5 READING
- 6 ASTRONOMY
- 7 PAINTING
- 8 GARDENING

# ENGLISH PUZZLES-3

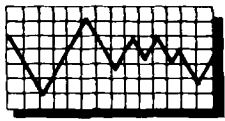

# Doctor!

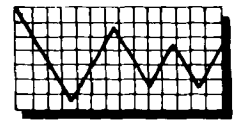

The last line of a joke is called the *punchline*. Find the correct punchline for each of these jokes. (All of the jokes are conversations between a doctor, *D*, and a patient, *P*.)

1

*P* Doctor, I've swallowed a pencil. What shall I do?

*D*

5

*P* Doctor, I'm very nervous. This is the first operation I've ever had.

*D*

2

*P* Doctor, I've lost my memory.  
*D* When did this happen?

*P*

6

*P* Doctor, I think I've become invisible.

*D*

3

*P* Good morning, doctor.  
*D* Good morning, Mr Jones. I haven't seen you for a long time.

*P*

7

*P* Doctor, after the operation, will I be able to play the violin?

*D* Yes, of course.

*P*

4

*P* What do you think, doctor?  
*D* Have you had this problem before?  
*P* Yes, doctor.

*D*

8

*P* Doctor, no-one is interested in me.

*D*

## Punchlines

That's fantastic! I've never been able to play it before.

I'm nervous too. It's the first operation I've ever done.

Well, you've got it again.

I know, doctor. I've been ill.

Use a pen.

Who said that?

Next!

When did what happen?



# NUMBERPLATES

Do you know the English words for the car parts marked in the pictures? The numberplates will help you: each numberplate includes the first letter and the last three letters of the word you need. For example, the first answer is MIRROR (the numberplate includes the letters M and ROR).

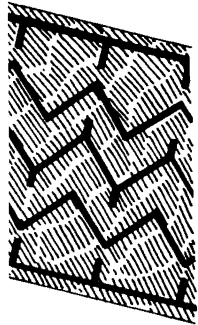
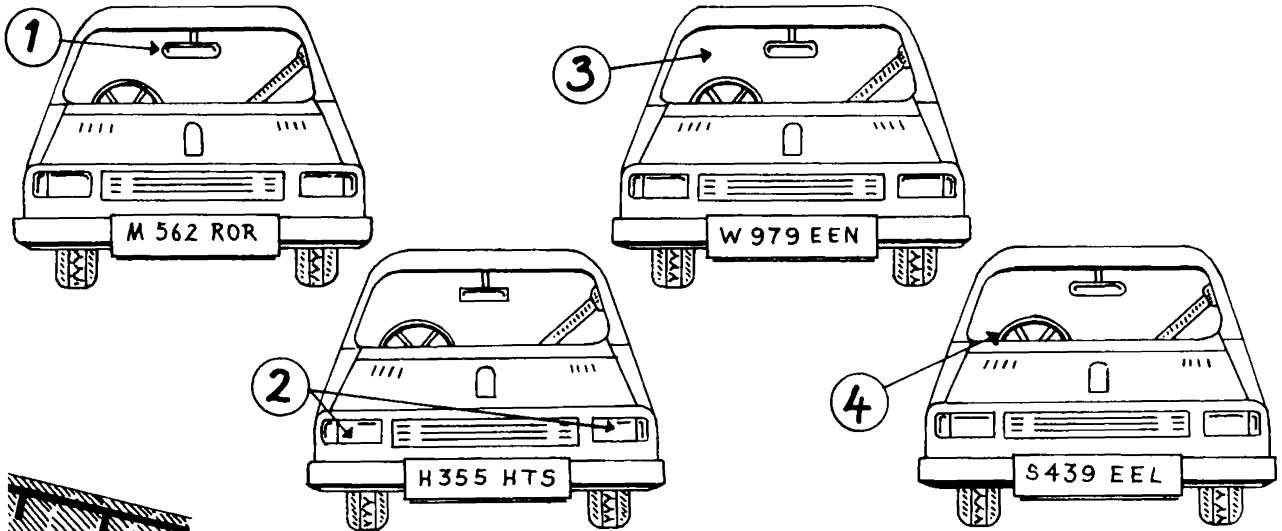

①	M	I	R	R	O	R											
②																	
③																	
④									-								
⑤																	
⑥																	
⑦																	
⑧																	

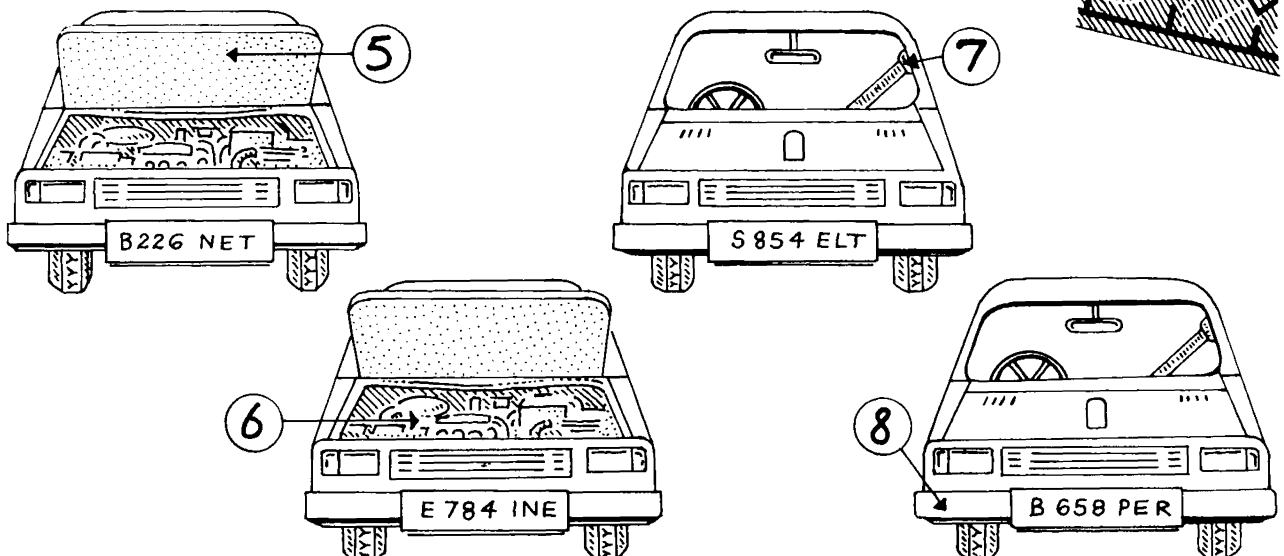
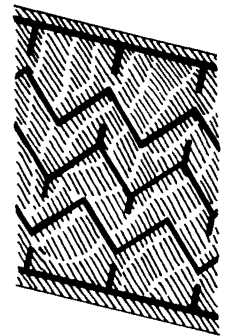

# Absurd riddles

There is a particular kind of riddle which we can call an 'absurd riddle'. Its answer is logical but silly (or 'absurd'). Here are two examples:

What is yellow and always points to the north? – A magnetic banana.

What is white and yellow and travels at 200 kilometres an hour? – A train-driver's egg sandwich.

Here are eight more absurd riddles. Complete the answers with the help of the pictures. (All the words you need are at the bottom of the page.)

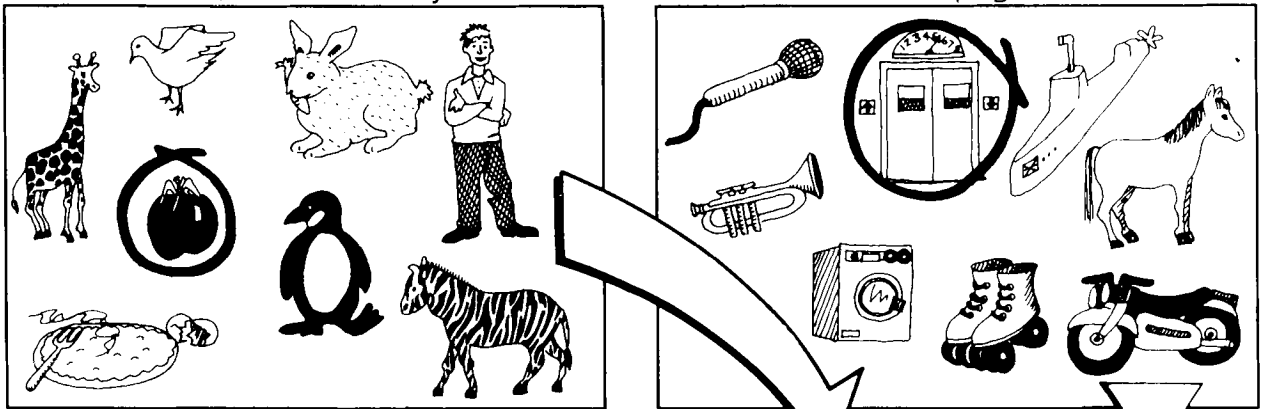

- |   |   |                                    |
|---|---|------------------------------------|
| 1 | What is red and goes up and down?                                       | A <u>tomato</u> in a <u>lift</u> . |
| 2 | What has six legs, four ears and a tail?                                | A _____ on a _____.                |
| 3 | What is soft and yellow and goes round and round?                       | An _____ in a _____.               |
| 4 | What is black and white and has eight wheels?                           | A _____ on _____.                  |
| 5 | What is black and white, has four legs and makes a lot of noise?        | A _____ with a _____.              |
| 6 | What can fly underwater?  | A _____ in a _____.                |
| 7 | What has big ears and can travel at 150 kilometres an hour underground? | A _____ on a _____.                |
| 8 | What is very tall and has a very loud voice?                            | A _____ with a _____.              |

One more question:

What is big and yellow and eats rocks?

bird giraffe horse lift man microphone  
motorbike omelette penguin rabbit  
rollerskates submarine tomato trumpet  
washing-machine zebra

# Crossword in two halves

This crossword is about verbs. Each clue gives you the Base Form and the Past Simple form of a verb – and the Past Participle is missing. For each verb, decide what the Past Participle is, and put it into the grid.

## Across

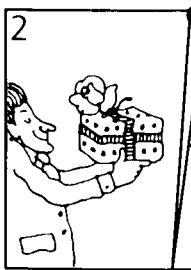
2  GIVE  
GAVE

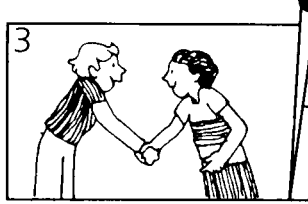
3  MEET  
MET

5  STAND  
STOOD

7  WRITE  
WROTE

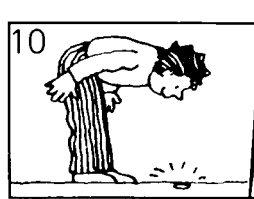
10  FIND  
FOUND

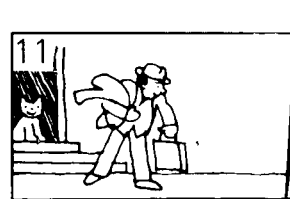
11  LEAVE  
LEFT

12  SING  
SANG

13  THINK  
THOUGHT

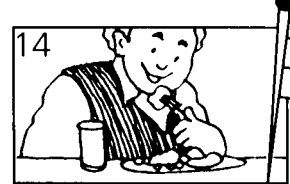
14  EAT  
ATE

## Down

1  SAY  
SAID

2  GO  
WENT

4  TEACH  
TAUGHT

5  SLEEP  
SLEPT

6  DRINK  
DRANK

8  TAKE  
TOOK

9  SEE  
SAW

## Part A

## Part B

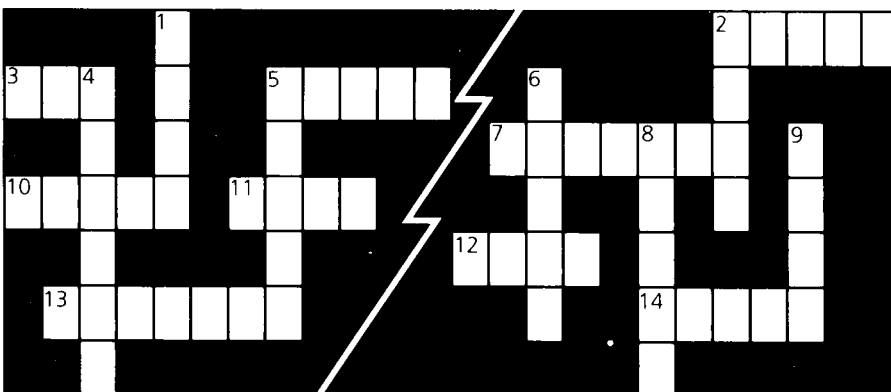

## Question:

The crossword is divided into two halves. Can you think of a reason why the verbs in Part A are different from the verbs in Part B? (Look carefully at their Past Simple forms and their Past Participles.)

# Silent letters

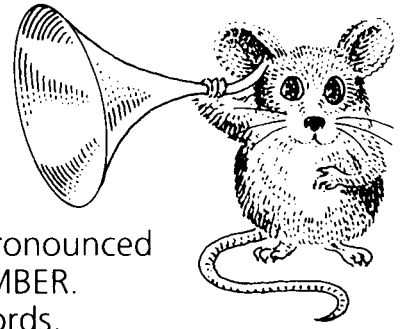

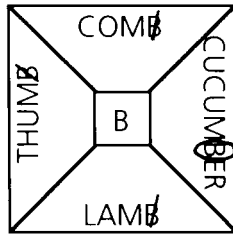

Look at this group of four words:



The letter B is only pronounced in one word: CUCUMBER. In the other three words, the letter B is silent: COMB, LAMB, THUMB.

Mark the words in these groups in the same way. In each group:

-  circle the letter in the word in which it is pronounced.
-  cross out the letter in the three words in which it is silent.

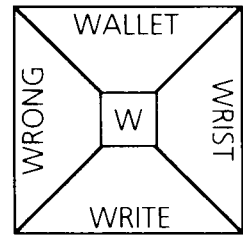
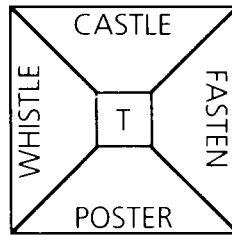
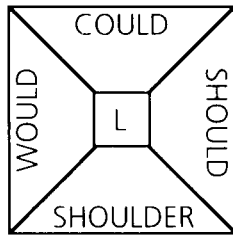
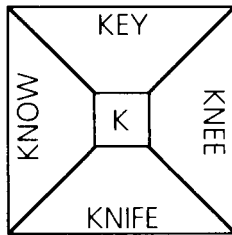
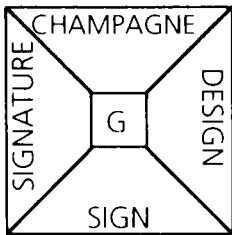

These pictures represent some of the words in the six groups.

For each one, write the correct letter in the square.

12 numbered puzzles, each consisting of a triangle with a picture and a small square at the bottom for a letter:

1. Picture: Comb. Square: B
2. Picture: Foot with shoe. Square: (empty)
3. Picture: Whistle. Square: (empty)
4. Picture: Knife. Square: (empty)
5. Picture: Castle. Square: (empty)
6. Picture: Lamb. Square: (empty)
7. Picture: Corn and coins. Square: (empty)
8. Picture: Hand with thumb up. Square: (empty)
9. Picture: Champagne glass and bottle. Square: (empty)
10. Picture: Key. Square: (empty)
11. Picture: Hand with index finger circled. Square: (empty)
12. Picture: Signet ring. Square: (empty)
13. Picture: Person with backpack. Square: (empty)



# Imaginary jobs and real jobs

Here are two imaginary jobs:

And here are two real jobs:

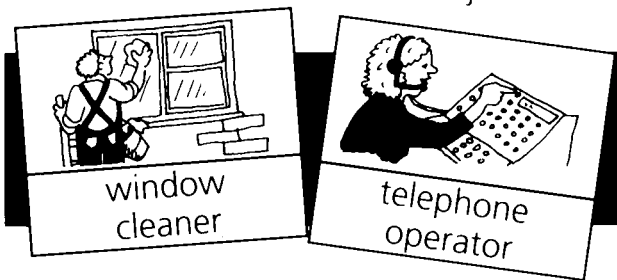
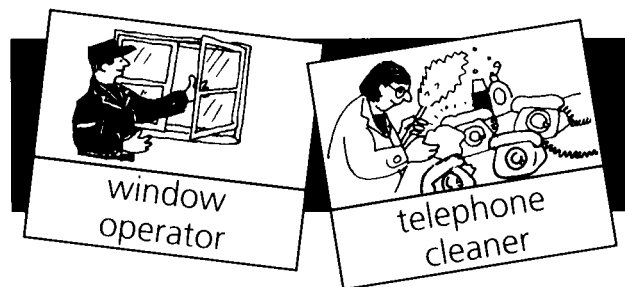

From this list of twelve imaginary jobs, put the correct first and second parts together to find the real jobs shown in the pictures. Write each real job under the correct picture.

1

2

3

4

5

computer    dancer

hotel        photographer

driving      manager

newspaper   singer

opera        programmer

rock         worker

film         driver

aircraft     director

ballet       editor

construction instructor

lorry        musician

wedding     technician

8

9

10

11

12





# Pairs of words







First, put these nine words in the correct places below:

TAP US DAN PIP  
CAN NOT PIN PET  
HAT

Then, by adding the letter E to the end of each word on the left, make nine other words and write them in the correct places here:

Join the pairs of words:

	CAN
	
Short form of DANIEL.	
	
A dog, a cat or a goldfish, for example.	
	
	
'To be or <span style="background-color: black; color: black;">      </span> to be.'	
I → me we → <span style="background-color: black; color: black;">      </span>	

	
	Person from Denmark.
	
	
CANE	
	
	
	Opposite of LOVE.
	Short form of PETER.

**Question:** What is special about the pronunciation of the words in the pairs (can/cane, etc.)?

# Abbreviations

Complete the crossword grid by putting in the full forms of the twenty-two abbreviations.

**Dr. Graham Kent**  
25 Market Sq.  
Shakespeare Rd.  
Birchchester

**Prof. Margaret Baker**  
Dept. of Linguistics  
Churchill Bldg  
Univ. of Birchchester  
Milton Ave.  
Birchchester

**The Johnson Computer Co. Ltd.**  
77-79 King St.  
Birchchester

**SOME WORLD RECORDS**  
The highest active volcano:  
Ojos del Salado, 6885 m. (22588 ft.)  
The longest river:  
The Nile, 6670 kms. (4145 mls.)  
The longest space flight:  
Vladimir Titov and Musa Manarov,  
365 days 22 hrs. 39 mins. 47 secs.  
(21 Dec. 1987 - 21 Dec. 1988)

**A FAMOUS QUOTATION**  
Big Brother is watching you.  
- George Orwell,  
Nineteen Eighty-Four,  
Pt. 1, Chap. 1, p. 1

# A Strange Quiz

The questions in this quiz are *riddles* – they may appear strange, but they all have logical answers. Find the correct answers in the box, and write them under the questions.

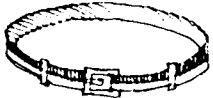
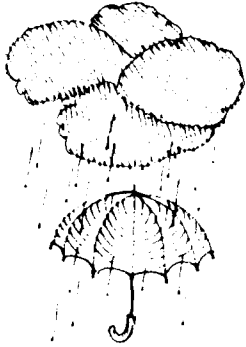

- ① What do elephants do when it rains?  
\_\_\_\_\_
- ② Why do businessmen carry umbrellas?  
\_\_\_\_\_
- ③ What kind of umbrella does a businessman carry when it's raining very hard?  
\_\_\_\_\_
- ④ Twelve businessmen were standing under one small umbrella, but none of them got wet. Why?  
\_\_\_\_\_
- ⑤ Why did William Shakespeare wear a red and green belt?  
\_\_\_\_\_
- ⑥ Who wears the biggest boots in the army?  
\_\_\_\_\_
- ⑦ What can you add to a bucket of water to make it lighter?  
\_\_\_\_\_
- ⑧ What can fall on water without getting wet?  
\_\_\_\_\_
- ⑨ How do you stop water coming into your house?  
\_\_\_\_\_
- ⑩ What kind of lion has purple feet?  
\_\_\_\_\_
- ⑪ Why do giraffes have long necks?  
\_\_\_\_\_
- ⑫ Why do white sheep sleep more than black sheep?  
\_\_\_\_\_

The soldier with the biggest feet.

Holes.

A very wet one.

The kind that makes its own wine.

Because there are more of them.

Because it wasn't raining.

Because umbrellas can't walk.

A shadow.

To join their heads to their bodies.

To keep his trousers up.

They get wet.

Stop paying your water bill.

# A very official jigsaw

Find a more formal or 'official' way of saying each of these things. You can find the 'official' versions in the jigsaw. The words of each sentence are on pieces which are joined together.

**1**

WHAT'S YOUR JOB?

WHAT IS YOUR OCCUPATION?

**2**

ARE YOU MARRIED?

**3**

HOW OLD ARE YOU?

**4**

HOW TALL ARE YOU?

**5**

HOW MUCH DO YOU WEIGH?

**6**

WHICH COUNTRY DO YOU LIVE IN?

**7**

WHAT'S YOUR ADDRESS?

WHAT	WHAT	IS
IS	YOUR	YOUR
WHAT	COUNTRY	OCCUPATION?
IS	OF	RESIDENCE?
YOUR	WHAT	IS
HEIGHT?	WHAT	YOUR
WHAT	IS	AGE?
IS	YOUR	MARITAL
YOUR	WHAT	STATUS?
FULL	IS	YOUR
POSTAL	ADDRESS?	WEIGHT?

The replies in these nine conversations are not very polite. Find a polite way of saying each one. All the polite sentences you need are in the jigsaw. The words of each sentence are on pieces which are joined together.

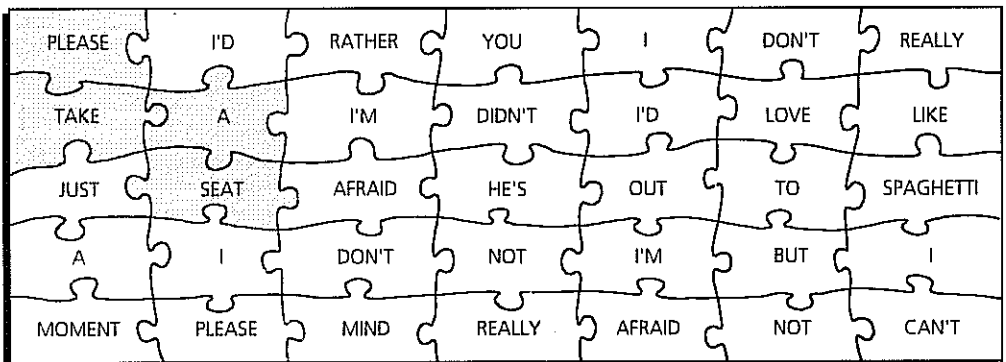
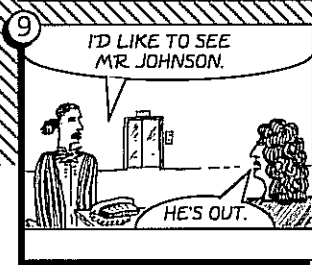
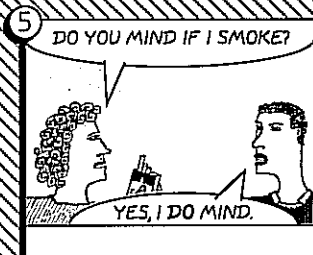
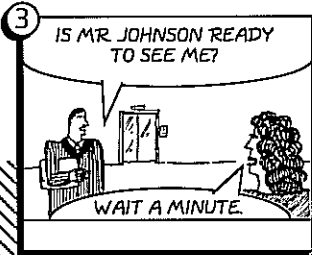
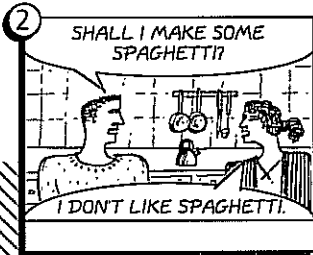
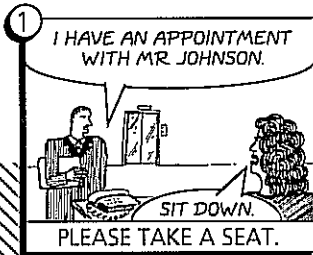

Put the missing words from the conversations into the grid, vertically. If you complete the grid correctly, the job of one of the people in the pictures will appear in the special squares, horizontally.

THE LINE'S **9**. I'LL TRY AGAIN LATER.

IS A VERY BAD LINE. COULD YOU SPEAK **11** A BIT?

IT'S RINGING, BUT THERE'S NO **8**.

COULD I SPEAK **16** SUSAN JONES, PLEASE?

I THINK YOU HAVE THE **13** NUMBER.

COULD I **5** TO DR. WATSON, PLEASE?

**12**.

COULD I SPEAK TO MR. SMITH, **4**?

I'LL PUT **7** THROUGH. WHO'S **14**?

**1** 2582, PLEASE.

PUTTING YOU **17**.

IF YOU'D LIKE TO **3** A **2**, PLEASE SPEAK **15** THE **10**.

<b>1</b>	<b>3</b>	<b>5</b>	<b>7</b>	<b>9</b>	<b>11</b>	<b>13</b>	<b>15</b>	<b>17</b>
	<b>2</b>	<b>4</b>	<b>6</b>	<b>8</b>	<b>10</b>	<b>12</b>	<b>14</b>	<b>16</b>
			T					
			H					
			I					
			S					

In each of these conversations, make the reply 'stronger' – more *emphatic* – by adding a word.

You can find the emphatic versions of the replies in the jigsaw. (The words of each reply are on pieces which are joined together.)

1. ANIMALS SHOULD NOT BE KEPT IN ZOOS. YOU'RE RIGHT. YOU'RE ABSOLUTELY RIGHT.

2. WHERE DID THE ACCIDENT HAPPEN? HERE.

3. WHAT DO YOU THINK OF MY NEW HAT? I LIKE IT.

4. CIGARETTE ADVERTISING SHOULD BE ILLEGAL. I AGREE.

5. WHEN ARE YOU LEAVING? NOW.

6. SPACE EXPLORATION IS A WASTE OF TIME AND MONEY. I DISAGREE.

7. ARE YOU FEELING BETTER? MUCH BETTER.

8. DO YOU THINK DRIVING WITHOUT A SEATBELT IS DANGEROUS? YES, I DO.

YOU'RE ABSOLUTELY VERY RIGHT NOW I  
 I RIGHT MUCH BETTER YES TOTALLY  
 REALLY I QUITE RIGHT I DISAGREE  
 LIKE IT AGREE HERE CERTAINLY DO

**Question:**

Can you make the sentences below more emphatic by using these grey pieces to replace the grey pieces in the sentences?

- NOT. HUGE EXHAUSTED. AGES. GREAT CAN'T STAND  
 DEFINITELY. TINY LOVE DEFINITELY

- (A) IT WAS A GOOD PARTY. (E) YES.  
 (B) I WAS BORN IN A SMALL VILLAGE. (F) NO.  
 (C) I'M TIRED. (G) I HAVEN'T SEEN YOU FOR A LONG TIME.  
 (D) TOKYO IS A BIG CITY. (H) I DON'T LIKE MODERN JAZZ.  
 (I) I'D LIKE TO VISIT PARIS.



# Grammar

# FILES

Here are eighteen files. On each file, there is an English grammatical term, but these terms are not written in full. What are the full forms? For example, ADJ'S means ADJECTIVES, and ADJ'S (POSS.) means ADJECTIVES (POSSESSIVE).

Write the full forms here. (If you have a problem, you can find all the words in the alphabetical list at the bottom of the page.)

ADJ'S 1	ADJ'S (POSS.) 2	ADV'S 3	ART. (DEF.) 4	ART. (INDEF.) 5
CONJ'S 6		NOUNS (UNC.) 7	NOUNS (C., SING.) 8	NOUNS (C., PL.) 9
PREP'S 10		PRON'S (SUBJ.) 11	PRON'S (OBJ.) 12	PRON'S (POSS.) 13
VERBS (REG.): INF. 14	VERBS (IRREG.): INF. 15	VERBS: -ing FM 16	VERBS: PAST SIMP. FM 17	VERBS: PAST PART. 18

List of files	
1	ADJECTIVES
2	ADJECTIVES (POSSESSIVE)
3	
4	
5	
6	
7	
8	
9	
10	
11	
12	
13	
14	
15	
16	
17	
18	

When you have done this puzzle, try the 'Documents for the files' puzzle.

SINGULAR	PLURAL	FORM	ADJECTIVES
SUBJECT	POSSESSIVE	INDEFINITE	ADVERBS
UNCOUNTABLE	PREPOSITIONS	INFINITIVE	ARTICLE
	PRONOUNS	IRREGULAR	CONJUNCTIONS
	REGULAR	OBJECT	COUNTABLE
	SIMPLE	PARTICIPLE	DEFINITE

# Documents for the FILES

**⚠** Do the 'Grammar files' puzzle before you do this one.

Each of the documents below belongs in one of the files on the opposite page. Read the words on each document and decide where it belongs. For example: The words *my, your, his, her, its, our* and *their* are Possessive Adjectives, so document A belongs in file 2.

The documents contain the following words:

- A:** my, your, his, her, its, our, their (File 2)
- B:** and, because, but, or, (etc.)
- C:** I, you, he, she, it, we, they
- D:** car, child, table, woman, (etc.)
- E:** begin, eat, see, take, (etc.)
- F:** a/an
- G:** arrived, asked, began, ate, (etc.)
- H:** always, here, recently, sometimes, (etc.)
- I:** mine, yours, his, hers, its, ours, theirs
- J:** arrived, asked, begun, eaten, (etc.)
- K:** at, from, into, with, (etc.)
- L:** cars, children, tables, women, (etc.)
- M:** arrive, ask, invite, stop, (etc.)
- N:** advice, information, luggage, music, (etc.)
- O:** blue, small, terrible, thin, (etc.)
- P:** the
- Q:** me, you, him, her, it, us, them
- R:** arriving, asking, beginning, eating, (etc.)

**Question:** Some of the documents don't have (etc.) at the end. Why not?

# Strong feelings

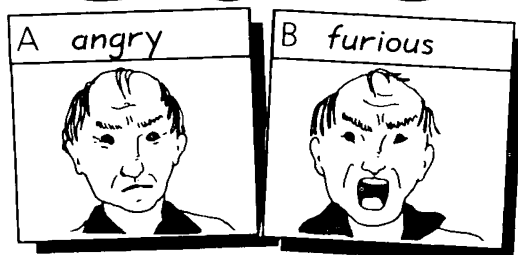

◀ In this pair of adjectives, B is *stronger* than A: 'furious' means 'very angry'.

Find six more pairs of adjectives, and write them in the correct pictures below. (Adjective B is always stronger than Adjective A.) You can find the letters of each adjective in one of the small grids – starting in the middle square and going in one of these directions:

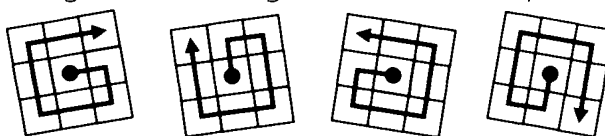

**A**

D	U	R
E	S	P
S	I	R

E	D	N	T
T	I	E	
S	E	R	

X	C
E	I
D	E

D		
L	P	E
E	A	S

D		
E	S	H
K	C	O

I	E	D
R	W	
R	O	

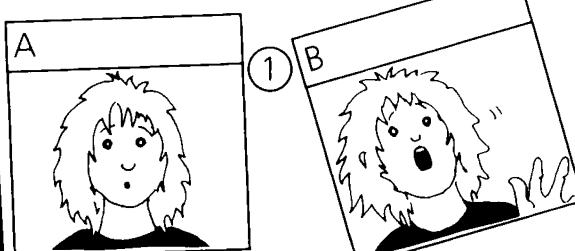

**B**

D	E	L
E	D	I
T	H	G

E	T	A
E	D	R
S	P	E

L	L	E
I	T	D
R	H	

S	H	E	D
I	A	S	
N	O	T	

D	E	I
O	H	F
R	R	I

I	N	A	
C	F	T	
S	A	E	D

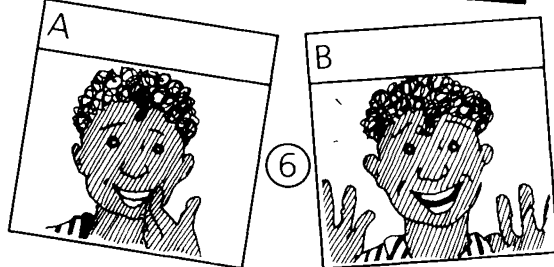
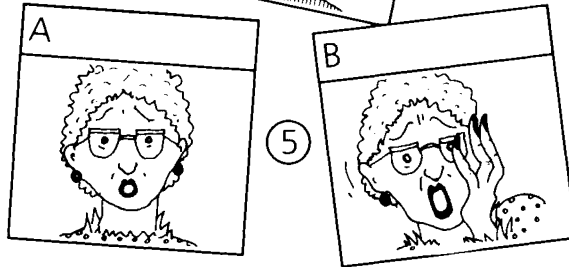
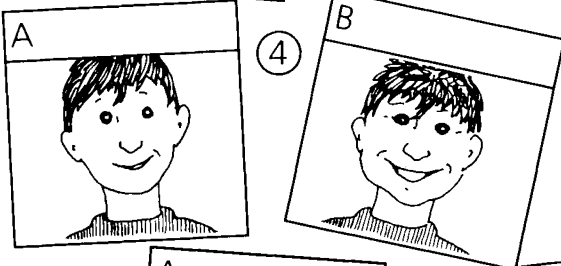
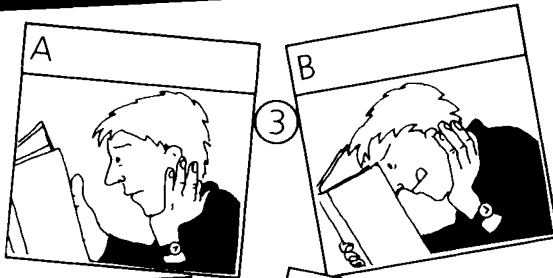

# Telegram LANGUAGE

In this telegram: **ARRIVING GATWICK AIRPORT FRIDAY 10.30.**

these words have been omitted: **I'LL BE AT ON AT**

The complete sentence is:  
**I'LL BE ARRIVING AT GATWICK AIRPORT ON FRIDAY AT 10.30.**

'Telegram language' is used in other kinds of writing too. There are some examples in this puzzle.

Read these seven texts, and put the numbers with the correct descriptions below:

Then write each text in complete sentences. These are the words which have been omitted:

**I THE THE WAS**  
**THE THEM**  
**WE'RE THE IS WE'LL**  
**I'VE I'LL BE**  
**IF YOU HAVE YOU HAVE A**  
**THE HAS BEEN**  
**I I'LL BE ME**

	Descriptions	Complete sentences
	A newspaper headline	
	A sentence from a recipe	
	A sentence from a diary	
	Three sentences from a postcard	
	A proverb	
1	A message	<i>I've gone to lunch. I'll be back at 2.15.</i>
	Another message	

# Logical laws

Look at these two 'logical laws':



A person with one watch knows what time it is; a person with two watches is never sure.



In the summer, bus windows never open; in the winter, bus windows never close.



Here are eight more 'logical laws'. Work out what the missing words are, and put them into the crossword grid.

If anything can possibly go wrong, **1** will.

If several things can go wrong, the one that will cause most damage will be the one that **3** wrong. **2**

If you leave things to themselves, **4** get worse. **4**

If everything appears to be going well, you **5** forgotten something. **6**

If you know the difference **7** good advice and bad advice, you don't need advice. **7**

If you have to tell people you're famous, **8** aren't. **8**

If you **9** wearing one white shoe and **10** black **11**, you have another pair like that in the cupboard. **11**



If you tell someone that **12** are 300 billion stars **13** the universe, they will believe you. If you tell them that a chair has wet paint **14** it, they will touch it **15** be sure. **14**

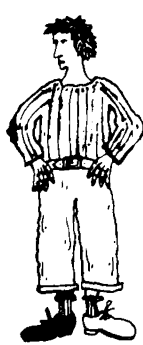

The crossword grid consists of 15 numbered starting points for words:

- 1: Down, 1st row, 1st column
- 2: Down, 2nd row, 1st column
- 3: Down, 1st row, 2nd column
- 4: Down, 1st row, 5th column
- 5: Down, 2nd row, 3rd column
- 6: Down, 2nd row, 4th column
- 7: Down, 3rd row, 1st column
- 8: Down, 1st row, 6th column
- 9: Down, 3rd row, 2nd column
- 10: Down, 1st row, 3rd column
- 11: Down, 1st row, 4th column
- 12: Down, 1st row, 7th column
- 13: Down, 2nd row, 5th column
- 14: Down, 2nd row, 6th column
- 15: Down, 3rd row, 4th column



# At the theatre

With just ten words, you can complete all the titles in this list of plays by British, Irish and American writers. The clues will help you to discover the ten words.

1	2	3	
by Alan Bennett			
ONE	FINE	4	
by Alan Bennett			
5			
by Edward Bond			
FATHERS	6	7	
by Brian Friel			
1	LONG,	1	SHORT
6	1	TALL	
by Willis Hall			
8	MY	7	
by Arthur Miller			
1	MAN	WHO	HAD
8	1	LUCK	
by Arthur Miller			
ANOTHER	3		
by Julian Mitchell			
TILL	1	4	
9	DIE		
by Clifford Odets			
10	SCHOOL		
by Harold Pinter			
2	TIMES		
by Harold Pinter			
A	10	OUT	
by Harold Pinter			
9	HAVE	BEEN	
HERE	BEFORE		
by J.B. Priestly			
10	6	4	
by Tom Stoppard			
MOTHER'S	4		
by David Storey			
SUDDENLY	LAST	5	
by Tennessee Williams			

- Clues
- 1 Definite article (three letters).
  - 2 Adjective, opposite of *young* (three letters).
  - 3 Noun – France, for example, or Brazil, or Japan . . . (seven letters).
  - 4 Noun, a period of twenty-four hours (three letters).
  - 5 Noun, the season when the weather is hot (six letters).
  - 6 Conjunction (three letters).
  - 7 Noun, opposite of *daughters* (four letters).
  - 8 Adjective, opposite of *no* (three letters).
  - 9 Pronoun (one letter).
  - 10 Noun, opposite of *day* (five letters).

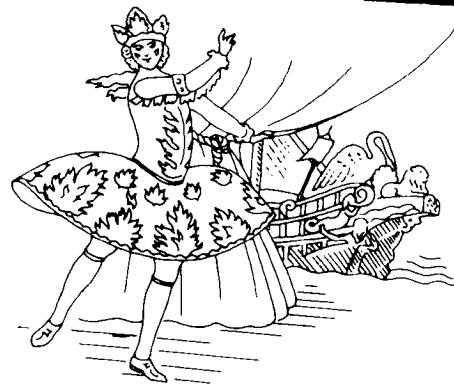

# Disc jockey

The disc jockey is planning to play twelve records. All twelve are about love – a very popular subject for songs! Read his list and complete each song title, using one of these words:

LOVE    LOVED    LOVING



1	DANNY WILSON 1989	IF YOU REALLY <input type="text"/> ME, LET ME GO.
2	TAYLOR DAYNE 1988	I'LL ALWAYS <input type="text"/> YOU.
3	A FLOCK OF SEAGULLS 1984	THE MORE YOU LIVE, THE MORE YOU <input type="text"/> .
4	GARY GLITTER 1972	I DIDN'T KNOW I <input type="text"/> YOU, TILL I SAW YOU ROCK'N'ROLL.
5	MICHAEL JACKSON 1987	I JUST CAN'T STOP <input type="text"/> YOU.
6	FREDDIE JACKSON 1987	HAVE YOU EVER <input type="text"/> SOMEBODY?
7	JOAN JETT 1988	I HATE MYSELF FOR <input type="text"/> YOU.
8	ALEXANDER O'NEAL 1988	WHAT CAN I SAY TO MAKE YOU <input type="text"/> ME?
9	QUEEN 1976	SOMEBODY TO <input type="text"/> .
10	OTIS REDDING 1966	I'VE BEEN <input type="text"/> YOU TOO LONG.
11	STING 1988	IF YOU <input type="text"/> SOMEBODY, SET THEM FREE.
12	THE ZOMBIES 1965	I REMEMBER WHEN I <input type="text"/> HER.

### Questions:

- In which three titles is the verb *love* in the *Present Simple*?
- In which two titles is *loved* the *Past Simple*?
- In which title is *loved* part of the *Present Perfect*?
- Which title is in the *Present Perfect Continuous*?



# House and garden

Label the parts of the house and garden. The letters you need for each thing are given, but not in the correct order.

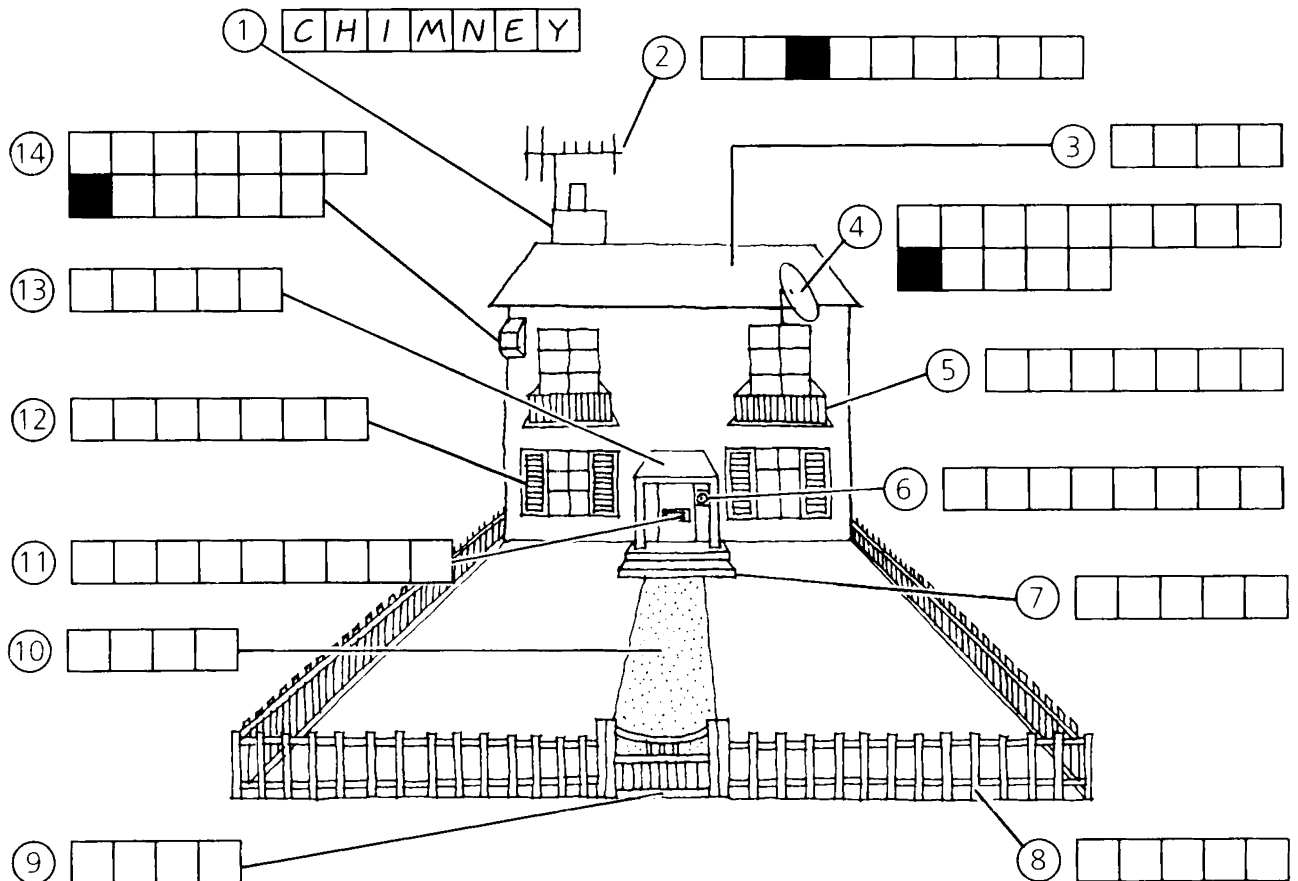
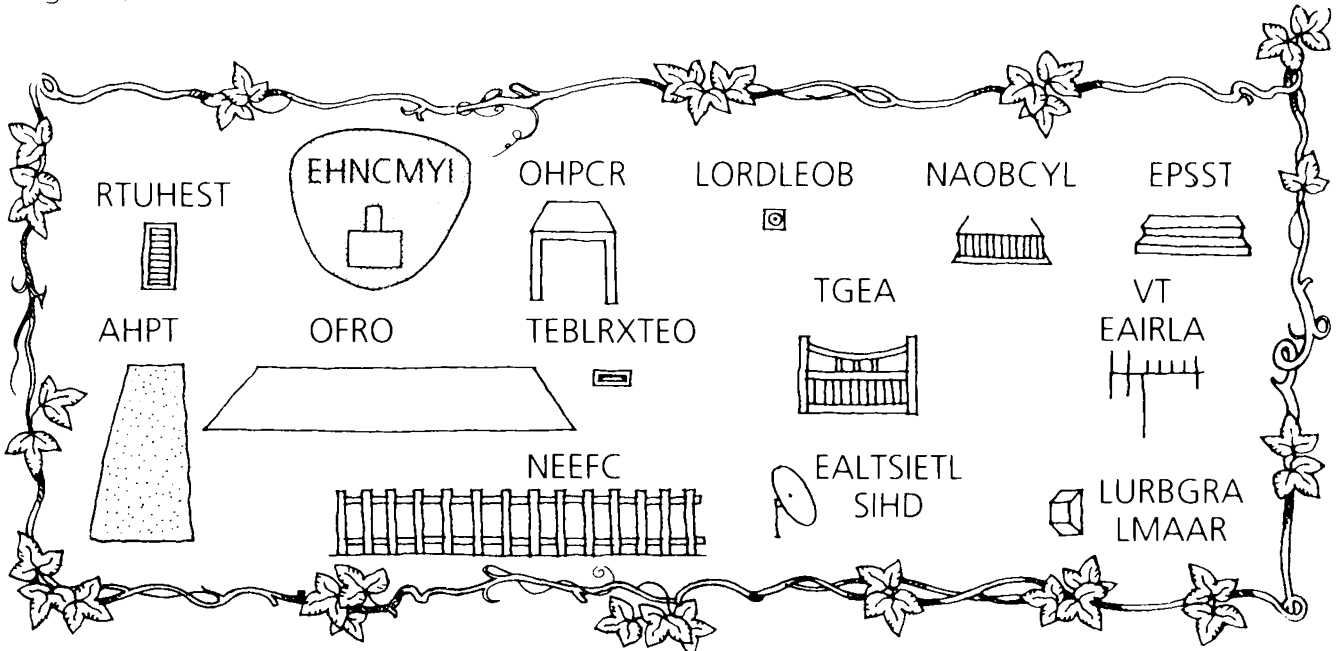



# What do they *really* mean?

Find the correct meaning for each of these road signs, and write it instead of the incorrect meaning. All the correct meanings are in the boxes at the bottom of the page. For example, the first sign doesn't *really* mean 'Danger: Sausages in road'. It means 'Roundabout'.

The image shows 15 numbered road signs with incorrect text labels. The signs are arranged in three rows. Below the signs is a cloud containing 13 boxes with correct meanings. A cartoon rabbit is near sign 8, a cartoon boy holding a burger is near sign 14, and a cartoon hand is near sign 5.

**Signs and their incorrect labels:**

- 1: Danger: Sausages in road
- 2: Danger: Large hat in road
- 3: Umbrellas must be carried
- 4: Underwater car park
- 5: Airport visitors this way
- 6: No snakes
- 7: No boomerangs
- 8: Low-flying motorcycles
- 9: Rocket launching site
- 10: Mountain road
- 11: Tunnel under mountain
- 12: Italian vehicles only
- 13: Pizza on sale here
- 14: Hamburgers on sale here
- 15: Bottles of lemonade on sale here

**Correct meanings (from the bottom boxes):**

- No motor vehicles
- Picnic area
- Road works ahead
- Hump ahead
- Parking area
- No U-turns
- Camping site
- Museum
- Low-flying aircraft
- Information
- Roundabout
- No right turn
- Quayside or river bank
- Hospital
- Road narrows on both sides



# **ENGLISH PUZZLES-3**

## **ANSWERS**

# Solutions

## Doctor!

Page 7

1. Use a pen.
2. When did *what* happen?
3. I know, doctor. I've been ill.
4. Well, you've got it again.
5. I'm nervous too. It's the first operation I've ever done.
6. Who said that?
7. That's fantastic! I've never been able to play it before.
8. Next!

## Numberplates

Page 8

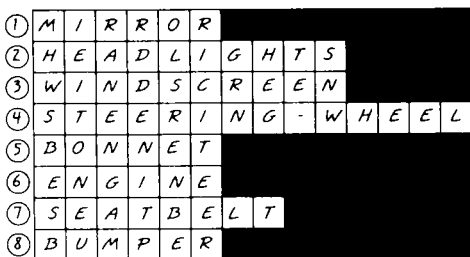

Note: In American English, *license plate* is used instead of *numberplate*; also, *windshield* is used instead of *windscreen*, and *hood* instead of *bonnet*.

## Absurd Riddles

Page 9

1. A tomato in a lift.
2. A man on a horse.
3. An omelette in a washing machine.
4. A penguin on rollerskates.
5. A zebra with a trumpet.
6. A bird in a submarine.
7. A rabbit on a motorbike.
8. A giraffe with a microphone.

The answer to the question *What is big and yellow and eats rocks?* is *A big yellow rock-eater*.

## Crossword in Two Halves

Page 10

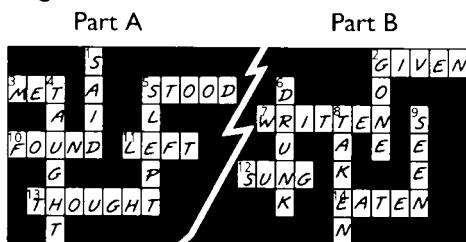

All the verbs are irregular, but:

- for the verbs in Part A, the Past Simple and the Past Participle are the same: *meet/met/met*, *say/said/said*, *stand/stood/stood*, etc;
- for the verbs in Part B, the Past Simple and the Past Participle are different: *give/gave/given*, *go/went/gone*, *write/wrote/written*, etc.

## Film Encyclopedia

Page 11

1. THE MAN WHO CAME TO DINNER.
2. THE MAN WITH THE GOLDEN GUN.
3. THE MAN FROM LARAMIE.
4. THE MAN ON THE EIFFEL TOWER.
5. THE MAN WHO WATCHED TRAINS GO BY.
6. THE MAN IN THE BACK SEAT.
7. THE MAN WHO SHOT LIBERTY VALANCE.
8. THE MAN IN THE WHITE SUIT.

Answer to question:

The hidden word in each title is *who*: THE BOY WHO STOLE A MILLION, THE GIRL WHO HAD EVERYTHING, THE SPY WHO LOVED ME, THE WOMAN WHO CAME BACK.

## Silent Letters

Page 12

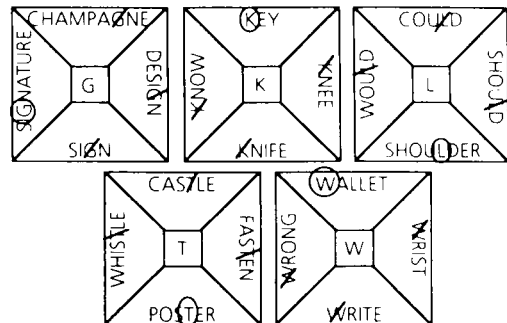

1. B
2. K
3. T
4. K
5. T
6. B
7. B
8. B
9. G
10. K
11. W
12. W
13. L

Remember these useful rules:

- In *-mb* at the end of a word, the *b* is always silent.
- In *-gn* or *-gne* at the end of a word, the *g* is always silent.
- In *kn-* at the beginning of a word, the *k* is always silent.
- In *wr-* at the beginning of a word, the *w* is always silent.
- In *could*, *should* and *would*, the *l* is always silent.
- In *-st-* in the middle of a word, the *t* is usually pronounced, but it is silent in some words.

## Football Team

Page 13

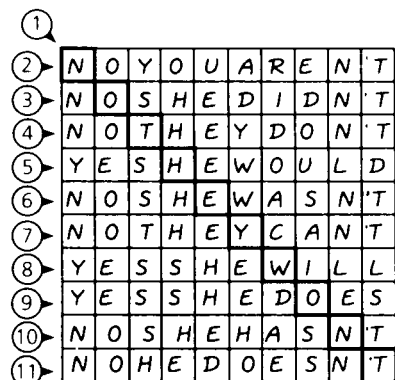

## Documents for the Files

### Page 43

A:2      D:8      G:17      J:18      M:14      P:4  
 B:6      E:15      H:3      K:10      N:7      Q:12  
 C:11      F:5      I:13      L:9      O:1      R:16

Answer to question:

In the documents which don't have (*etc.*) at the end, the lists of words are *complete*. Document A shows all the Possessive Adjectives; document C shows all the Subject Pronouns; document F shows the two forms of the Indefinite Article; document I shows all the Possessive Pronouns; document P shows the only form of the Definite Article, and document Q shows all the Object Pronouns.

In the documents which have (*etc.*) at the end, the lists of words are just *examples*. For instance, document B shows four conjunctions, but there are others.

## Strong Feelings

### Page 44

- |                  |               |
|------------------|---------------|
| 1. A) surprised  | B) astonished |
| 2. A) worried    | B) desperate  |
| 3. A) interested | B) fascinated |
| 4. A) pleased    | B) delighted  |
| 5. A) shocked    | B) horrified  |
| 6. A) excited    | B) thrilled   |

## Telegram Language

### Page 45

- A newspaper headline.  
The Prime Minister has been admitted to hospital.
  - A sentence from a recipe.  
Wash the apples in warm water and cut them into quarters.
  - A sentence from a diary.  
I wanted to go to the beach, but the weather was terrible.
  - Three sentences from a postcard.  
We're having a great holiday. The weather is marvellous. We'll see you in two weeks.
  - A proverb.  
If you have cold hands, you have a warm heart.
  - A message.  
I've gone to lunch. I'll be back at 2.15.
  - Another message.  
I need to speak to you urgently. I'll be at home all evening. Please phone me.
- Note: The proverb is always said in its 'telegram language' form, *Cold hands, warm heart*.

## Logical Laws

### Page 46

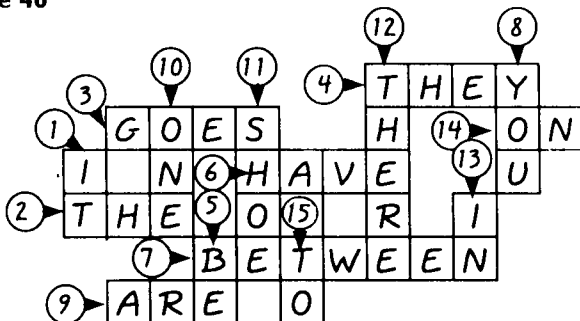

## At the Theatre

### Page 47

The ten words are:

- |            |           |           |
|------------|-----------|-----------|
| 1. THE     | 5. SUMMER | 9. I      |
| 2. OLD     | 6. AND    | 10. NIGHT |
| 3. COUNTRY | 7. SONS   |           |
| 4. DAY     | 8. ALL    |           |

So the titles of the plays are:

THE OLD COUNTRY  
 ONE FINE DAY  
 SUMMER  
 FATHERS AND SONS  
 THE LONG, THE SHORT AND THE TALL  
 ALL MY SONS  
 THE MAN WHO HAD ALL THE LUCK  
 ANOTHER COUNTRY  
 TILL THE DAY I DIE  
 NIGHT SCHOOL  
 OLD TIMES  
 A NIGHT OUT  
 I HAVE BEEN HERE BEFORE  
 NIGHT AND DAY  
 MOTHER'S DAY  
 SUDDENLY LAST SUMMER

## Disc Jockey

### Page 48

- |         |           |           |            |
|---------|-----------|-----------|------------|
| 1. love | 4. loved  | 7. loving | 10. loving |
| 2. love | 5. loving | 8. love   | 11. love   |
| 3. love | 6. loved  | 9. love   | 12. loved  |

Answers to questions:

1. (1) (3) (11)      2. (4) (12)      3. (6)      4. (10)

## House and Garden

### Page 49

- |                   |             |                   |
|-------------------|-------------|-------------------|
| 1. Chimney        | 6. Doorbell | 11. Letterbox     |
| 2. TV aerial      | 7. Steps    | 12. Shutter       |
| 3. Roof           | 8. Fence    | 13. Porch         |
| 4. Satellite dish | 9. Gate     | 14. Burglar alarm |
| 5. Balcony        | 10. Path    |                   |

## What Do They Really Mean?

### Page 50

- |                           |                                |
|---------------------------|--------------------------------|
| 1. Roundabout             | 9. Picnic area                 |
| 2. Hump ahead             | 10. Museum                     |
| 3. Road works ahead       | 11. Camping site               |
| 4. Quayside or river bank | 12. Information                |
| 5. Low-flying aircraft    | 13. Parking area               |
| 6. No U-turns             | 14. Hospital                   |
| 7. No right turn          | 15. Road narrows on both sides |
| 8. No motor vehicles      |                                |

## Interesting Facts

### Page 51

20, 80, 10, 3, 200, 4, 5, 5, 50, 7, 9, 27, 50, 30, TOTAL: 500

A woodpecker can peck *five hundred* times per minute.

## Folded Paper

Page 52

1. TOO MANY GAMES
  2. TOO MUCH TROUBLE
  3. ONE OF US
  4. MOST OF US ARE SAD
  5. HALF A MINUTE
  6. ONE MORE SATURDAY NIGHT
  7. NO MORE LONELY NIGHTS
- A ONE OF OUR AIRCRAFT IS MISSING  
 B ONE MORE RIVER  
 C ONE IN A MILLION  
 D ONE BY ONE

## What Are They Saying?

Page 53

- A How long have you been studying Chinese?
- B It's been raining all morning.
- C We've been looking forward to this holiday for months.
- D It's been doing that all morning.
- E I haven't been feeling very well recently, doctor.
- F How long have you been working on it?
- G Have you been waiting long?
- H You've been working too hard.

The tense is the *Present Perfect Continuous*. This tense is used in all the sentences in the pictures.

## The Second Half

Page 54

- |                              |                  |
|------------------------------|------------------|
| RICH MAN, POOR MAN           | Irwin Shaw       |
| BLUE EYES, BLACK HAIR        | Marguerite Duras |
| BLACK FACES, WHITE FACES     | Jane Gardam      |
| INSIDE, OUTSIDE              | Herman Wouk      |
| I'M O.K., YOU'RE O.K.        | Thomas A. Harris |
| DARK GREEN, BRIGHT RED       | Gore Vidal       |
| A LITTLE TEA, A LITTLE CHAT  | Christina Stead  |
| GOOD TIMES, BAD TIMES        | Harold Evans     |
| OTHER VOICES,<br>OTHER ROOMS | Truman Capote    |

Answers to questions:

- (A) The book about psychology is *I'm O.K., You're O.K.*  
 (B) The autobiography is *Good Times, Bad Times.*

## Grammatical Terms

Page 55

- |              |            |
|--------------|------------|
| A SENTENCES  | F VOWELS   |
| B SUFFIXES   | G LETTERS  |
| C SYLLABLES  | H WORDS    |
| D PHRASES    | I PREFIXES |
| E CONSONANTS |            |
1. In this phrase, there are three words.
  2. This word has nine letters.
  3. This word has a prefix and a suffix.
  4. This word has only one syllable.
  5. In this sentence, there are four words.
  6. In this word, there are four vowels and six consonants.

## Shopping List

Page 56

- |                  |               |
|------------------|---------------|
| 1. INK           | 6. TOOTHPASTE |
| 2. WRITING PAPER | 7. SARDINES   |
| 3. MATCHES       | 8. SELLOTAPE  |
| 4. JAM           | 9. CHOCOLATE  |
| 5. ORANGE JUICE  | 10. BISCUITS  |

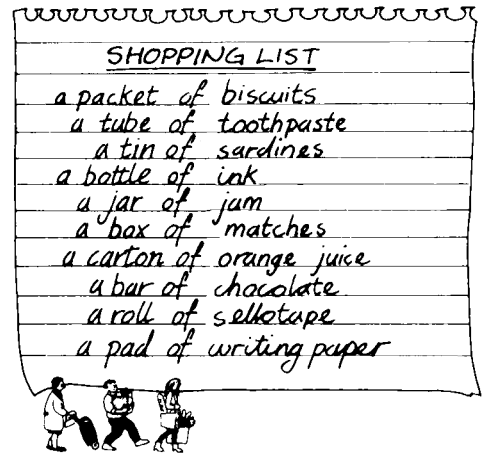

## More Logical Laws

Page 57

- |     |      |     |     |     |
|-----|------|-----|-----|-----|
| A:9 | B:3  | C:1 | D:7 | E:8 |
| F:4 | G:10 | H:6 | I:5 | J:2 |

## A Very Polite Jigsaw

Page 58

1. Please take a seat.
2. I don't really like spaghetti.
3. Just a moment, please.
4. I'd love to but I can't.
5. I'd rather you didn't.
6. I'm afraid not.
7. I don't mind.
8. Not really.
9. I'm afraid he's out.

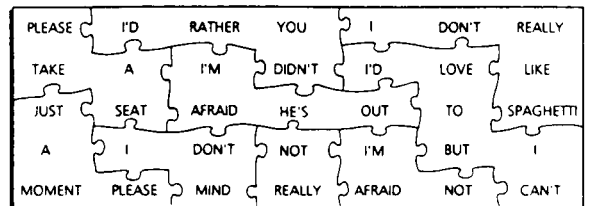

## Titles and Authors

Page 59

1. A HOT DAY IN SUMMER by I. Scream.  
(*I. Scream* sounds the same as 'ice-cream'.)
2. THE SOUTH POLE by Anne Tarktik.  
(*Anne Tarktik* sounds the same as 'Antarctic'.)
3. HORROR STORIES by R. U. Frightened.  
(*R. U. Frightened* sounds the same as 'Are you frightened?')
4. ON THE BEACH by C. Shorr.  
(*C. Shorr* sounds the same as 'sea shore'.)
5. THE JUDGE HAS JUST COME IN by Stan Dupp.  
(*Stan Dupp* sounds the same as 'Stand up'.)
6. DON'T BE LATE by Justin Tyme.  
(*Justin Tyme* sounds the same as 'just in time'.)

**3 Play**

**Games  
with  
English**

**PLAY GAMES  
WITH  
ENGLISH**



# CONTENTS

**WS** – Worksheet  
**TN** – Teaching notes

1. Connections1 (WS)
2. Connections1 (TN)
3. Instructions (WS)
4. Instructions (TN)
5. Observation 5 (WS)
6. Observation 5 (TN)
7. Differences-2 (WS)
8. Differences-2 (TN)
9. True Or False (WS)
10. True Or False (TN)
11. Connections 7 (WS)
12. Opposites Quiz (WS)
13. Opposites Quiz (TN)
14. Observation 4 (WS)
15. Observation 4 (TN)
16. Categories (Both-All) (WS)
17. Categories (Both-All) (TN)
18. Observation 4 (WS)
19. Observation 4 (TN)
20. Memory 4 (WS)
21. Memory 1 (WS)
22. Memory (TN)
23. The Name Game (things in a room) (WS)
24. The Name Game (things in a room) (TN)
25. Shadows (WS)
26. Shadows (TN)
27. Opposites (WS)
28. Opposites (TN)
29. Mime (WS)
30. Mime (TN)
31. Categories (WS)
32. Categories (TN)
33. The Name Game (Kitchen Utensils) (WS)
34. The Name Game (Kitchen Utensils) (TN)
35. Memory 1 (WS)
36. Memory 1 (TN)
37. Definitions (WS)
38. Definitions (TN)
39. Categories 1 (WS)
40. Categories 1 (TN)
41. Memory 7 (WS)
42. Memory 7 (TN)
43. Close Ups (have something done) (WS)
44. Close Ups (have something done) (TN)

# CATEGORIES 2

Find the words for each category.  
Write a sentence using **both** or **all**.

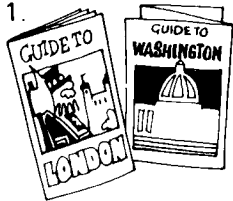

CAPITAL CITIES

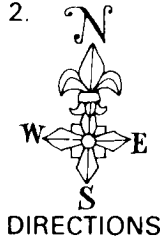

DIRECTIONS

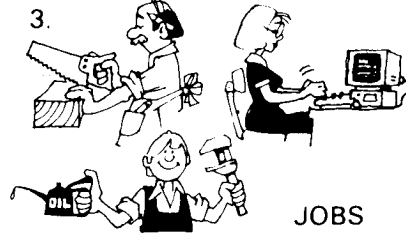

JOBS



ROOMS

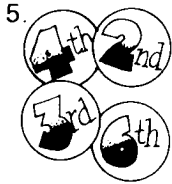

NUMBERS

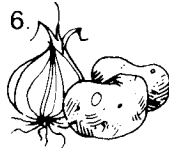

VEGETABLES



SPORTS

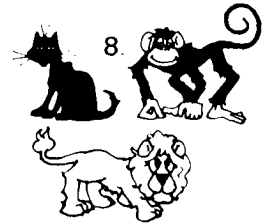

ANIMALS

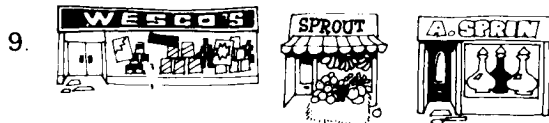

SHOPS



VEHICLES

Use these words:

football    monkey    carpenter    third    North    lorry    bus    golf  
 cat    East    fourth    London    tennis    secretary    South  
 bathroom    supermarket    chemist's    greengrocer's    West    Washington    mechanic  
 sixth    second    potatoes    lion    kitchen    onions

1. London, Washington. They're both capital cities.
2. North, South, East, West. They're all directions.
3. ....
4. ....
5. ....
6. ....
7. ....
8. ....
9. ....
10. ....

## CATEGORIES 2

**Both/All:** *They're both capital cities.  
 They're all directions.*

Working individually (or in pairs), the players write sentences placing the 28 words into ten categories. The first player to do this correctly is the winner.

- |                 |  |
|-----------------|--|
| <b>ANSWERS:</b> | <ol style="list-style-type: none"> <li>1. London, Washington. They're both capital cities.</li> <li>2. North, South, East, West. They're all directions.</li> <li>3. Carpenter, secretary, mechanic. They're all jobs.</li> <li>4. Bathroom, kitchen. They're both rooms.</li> <li>5. Fourth, second, third, sixth. They're all numbers.</li> <li>6. Onions, potatoes. They're both vegetables.</li> <li>7. Football, golf, tennis. They're all sports.</li> <li>8. Cat, lion, monkey. They're all animals.</li> <li>9. Greengrocer's, chemist's, supermarket. They're all shops.</li> <li>10. Lorry, bus. They're both vehicles.</li> </ol> |
|-----------------|--|

## SIMILARITIES GAME

**Both/All:** *They both speak English.  
 They're all ways of cooking food.*

Ask each player in turn to state some sort of similarity between two or more words, e.g.

- |           |  |
|-----------|--|
| You:      | <i>What can you tell me about an Australian and an American?</i> |
| Player 1: | <i>They both speak English.</i>                                  |
| You:      | <i>What can you tell me about boiling, frying and baking?</i>    |
| Player 2: | <i>They're all ways of cooking food.</i>                         |

Score 2 points for each answer; 1 point if *both* or *all* are wrongly used. At the end, the player with the most points is the winner.

**Sample questions** (adapt to the knowledge of your class).

- |                        |  |
|------------------------|--|
| <i>Capital cities:</i> | Paris, London, Washington                                  |
| <i>Materials:</i>      | wool, cotton   |
| <i>Cars:</i>           | a Mini, a Toyota, a Golf, a Jaguar                         |
| <i>Vegetable:</i>      | peas, beans  |
| <i>Ports:</i>          | Hamburg, Liverpool, New York                               |
| <i>Rooms:</i>          | kitchen, bathroom  |
| <i>Fuels:</i>          | coal, oil  |
| <i>Meat:</i>           | beef, pork, lamb, chicken                                  |
| <i>Fruit:</i>          | orange, lemon, apple                                       |
| <i>Actors:</i>         | Gerard Depardieu, Robert de Niro,<br>Arnold Schwarzenegger |
| <i>Trees:</i>          | oak, beech   |
| <i>Scientists:</i>     | Einstein, Galileo, Copernicus                              |

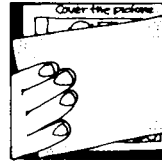
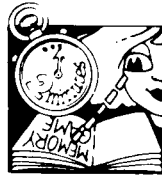
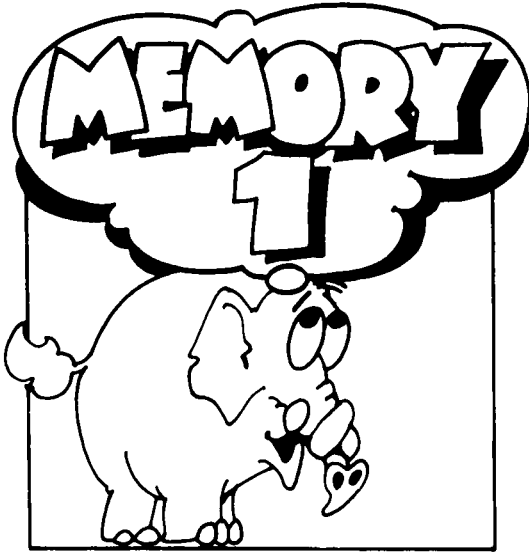

1. Look at the picture for two minutes.

2. Cover the picture.

3. Write down all the things you can remember.

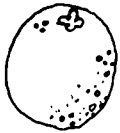

orange



pie



apple

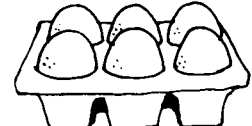

eggs



tomatoes

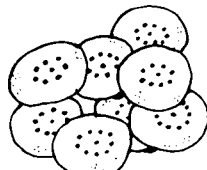

biscuits



sandwiches

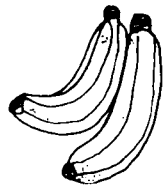

bananas



cakes

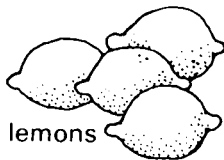

lemons



cabbage



potatoes



sweets

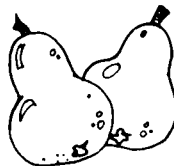

pears



onions

*an apple, seven tomatoes, a pie...*

.....

.....

.....

.....

.....

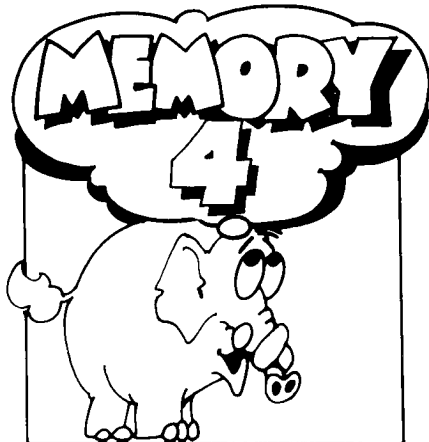

Frank is waiting at the bus stop. It's 8.20 in the morning. Frank is going to work. Look at the picture of Frank's flat. He was having breakfast there a few moments ago.

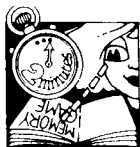
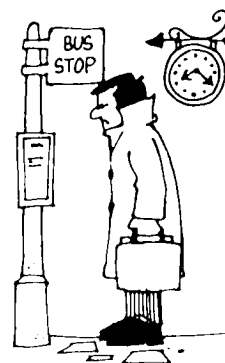

1. Look at this picture for two minutes.



2. Turn the page over.



3. Answer the questions on the second page.

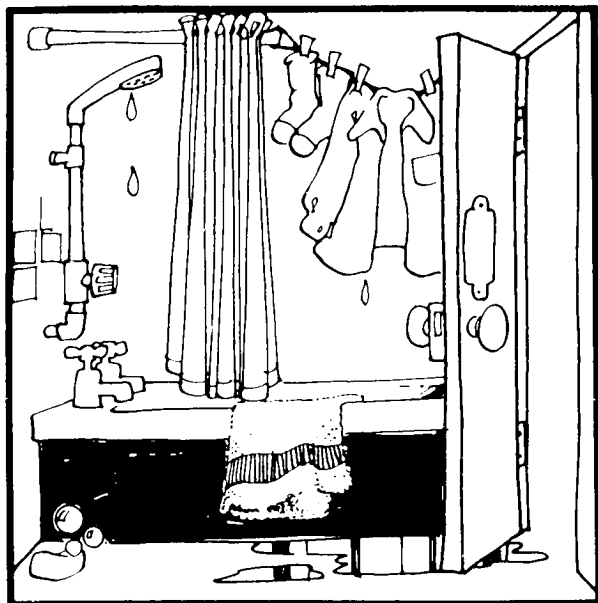

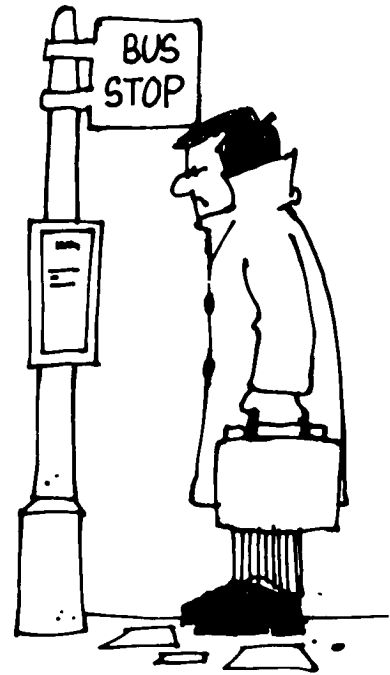

Answer these questions about the picture.

1. Did he make the bed? ..... *No, he didn't.*
2. Did he have breakfast? ..... *Yes, he did.*
3. Did he have coffee for breakfast? .....
4. Did he have an egg? .....
5. Did he close the window? .....
6. Did he open his mail? .....
7. Did he read the morning newspaper? .....
8. Did he wash up the dishes? .....
9. Did he take his umbrella to work? .....
10. Did he have a shower this morning? .....
11. Did he do any washing? .....
12. Did he switch off the gas? .....
13. Did he switch off the light in the bedroom? .....
14. Did he make the bed? .....

## MEMORY 4

**Past Simple:** *No he didn't. Yes he did.*

**Photocopy pages 65 and 94 to play this game.**

Divide the class into small teams of two to three players and appoint team secretaries. Hand out page 65 and give the teams two minutes to study and memorise the pictures. Then get the teams to cover or hand you back page 65. Hand out page 94 and go through the example with the class. The team secretaries, helped by the rest of their team, write down the answers to the questions on page 94. They must not look at the first page while doing this. The team with the most correct answers is the winner.

**Hints:** Practise *he didn't* sentences by getting the class to say what Frank didn't do this morning, e.g.:

*He didn't switch off the light.  
He didn't close the window.  
etc.*

<b>ANSWERS:</b>	1. No, he didn't.	7. Yes, he did.	13. No, he didn't.
	2. Yes, he did.	8. No, he didn't.	14. No, he didn't.
	3. No, he didn't.	9. No, he didn't.	
	4. Yes, he did.	10. Yes, he did.	
	5. No, he didn't.	11. Yes, he did.	
	6. Yes, he did.	12. Yes, he did.	

## CAN'T REMEMBER STORY

**Past Simple:** *Did he get up at seven?*

*He got up at a quarter to twelve.*

Explain to the class that it was Frank's birthday yesterday (that is why he was in such a rush this morning), and that you are going to tell them what Frank did on this very special day. Begin to tell the story, then break off as though you can't remember:

You: *Yesterday was Frank's birthday. In the morning he got up at ... er ... he got up at ... I'm sorry, I can't remember. Ask me 'Did he get up at ...?'*

Player: *Did he get up at seven?*

You: *No, he didn't get up at seven.*

Player: *Did he get up at ten?*

You: *No, he didn't get up at ten.*

Player: *Did he get up at a quarter to twelve?*

You: *Yes, he did. He got up at a quarter to twelve.*

Guide the players to the right answer by saying a definite *No* if they are way off the mark, and an encouraging *No* if they are getting warm. (If nobody can guess, accept any reasonable alternative as the 'correct' answer.)

*Yesterday was Frank's birthday. In the morning he got up at a quarter to twelve. For his breakfast he had ... er, he had ... I'm sorry, I can't remember. Ask me 'Did he have ...?'*

When they have found out what Frank had, begin again, retelling the story in full each time with the help of the class, and breaking off at the appropriate points for them to guess what happened.

### The complete story

*Yesterday was Frank's birthday. In the morning he got up at ... a quarter to twelve. For breakfast he had ... fish and chips. In the afternoon he went to ... the zoo. He rode on ... a camel and bought ... an ice-cream. In the evening he went to the cinema and saw ... a horror film.*

# MIME GAME

What are these people doing?

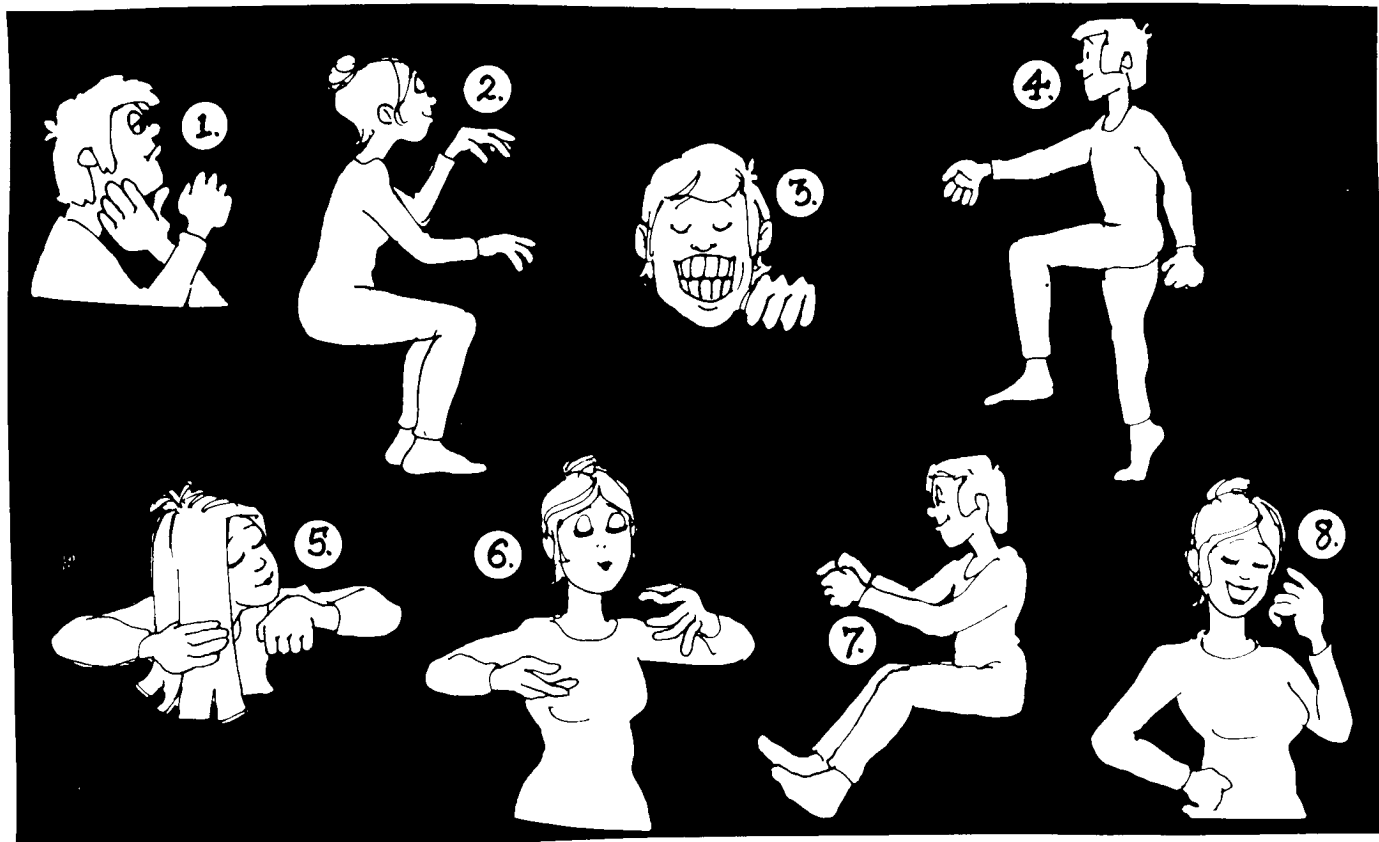

Use these words:

shave

clean his teeth

comb her hair

drive a car

go upstairs

drink a cup of tea

phone

play the piano

1. *He's shaving.*
2. ....
3. ....
4. ....
5. ....
6. ....
7. ....
8. ....



## MIME GAME

**Present Continuous:** *He's shaving.*

Divide the class into small teams of two to three players and appoint team secretaries. Set a time limit of five to eight minutes for the team secretaries, helped by the rest of their team, to write down the actions being mimed in the pictures. The team with the most correct sentences is the winner.

**Hints:** Point out the spelling rule SHAVE + ING = SHAVING before playing the game.

- |                 |                             |                                 |
|-----------------|-----------------------------|---------------------------------|
| <b>ANSWERS:</b> | 1. He's shaving.            | 5. She's combing her hair.      |
|                 | 2. She's playing the piano. | 6. She's drinking a cup of tea. |
|                 | 3. He's cleaning his teeth. | 7. He's driving.                |
|                 | 4. He's going upstairs.     | 8. She's telephoning.           |

## MIME GAME – extension

**Present Continuous:** *Are you combing your hair?*  
*Yes, I am./No, I'm not.*

Ask one of the players to write an action on a slip of paper and hand it to you, without any of the other players seeing it. Mime the action for the rest of the group to guess: *Are you combing your hair? Are you brushing your hair?* Answer with *Yes, I am* or *No, I'm not*. (Your mime does not have to be good — the more amateur the mime, the more questions will have to be asked.) Give verbal hints if necessary. The player who guesses the right answer then gets the chance to mime an action for the others to guess, and so on, until everyone has had a turn.

**Hints:** You could practise *Is he/Is she* questions by getting two students to think of an action; one then mimes the action while the other answers the questions. If the players cannot think of an action to mime, you could suggest *washing hands, telephoning, driving a car, playing chess, lighting a fire, making an omelette, having a shower*. Another variant of the game is to suggest different categories such as *eating something, cooking something, doing something in the house, playing a game*. Each player then has to mime, for example, eating a different kind of food for the others to guess, e.g. *eating spaghetti, eating an egg, eating peas*.

# OBSERVATION 4

There are some deliberate mistakes in this nineteenth century family scene.



There are seven mistakes. Can you find them?

Use these verbs:

wear

watch

use

drink

eat

listen to

have

1. *People didn't wear jeans.*
2. ....
3. ....
4. ....
5. ....
6. ....
7. ....

## OBSERVATION 4

**Past Simple:** *People didn't wear jeans.*

Divide the class into small teams of two to three players and appoint team secretaries. Give the teams eight minutes to spot the deliberate mistakes and for the team secretaries, with the help of the rest of their team, to write down the answers in complete sentences. The team with the most correct sentences is the winner.

**Hints:** Afterwards you could ask the class what people **did** wear, **did** write with, etc. in 1850.

**ANSWERS:**

People didn't watch television/TV.  
 People didn't listen to disco music.  
 People didn't use vacuum cleaners.

People didn't eat hamburgers.  
 People didn't have computers.  
 People didn't drink Coke.

## YOU DO IT LIKE THIS

**Past Simple:** *You didn't turn off the tap.*

Give each player quite a complex task to mime, e.g. *cleaning his or her teeth, starting a car, doing the washing up, making an omelette, shaving, changing a wheel, telephoning from a coin box.*

Each player in turn then mimes his or her task. Explain that it is not important if their mime is not very good but that they should try to represent **all** the different actions associated with their task. (e.g. *cleaning teeth — turning on tap, unscrewing top from toothpaste, picking up toothbrush, putting it under the tap, etc.*)

The rest of the class watch each mime and say afterwards what, in their opinion, wasn't represented, e.g.

*You didn't spit out the water.  
 You didn't turn off the tap.*

The player who mimes a task where nobody can make such comments is the winner.

## DETECTIVE STORY— 'ROMEO AND JULIET'

**Past Simple:** *Did somebody break a glass?  
 Were they murdered?*

Read the story to the class, explaining any difficult vocabulary. Explain that the class must play detectives and find the solution to the problem.

### The story

*Romeo and Juliet are lying dead on the floor of the bedroom. There is some broken glass and some water on the floor. The door of the room is locked. The window is open.*

The class then ask you questions to find the solution to the story. They can only ask questions which have Yes/No answers, e.g. *Were they murdered? Did somebody break a glass?* Give hints to elicit questions, e.g.

*Ask me questions about the broken glass. Was the glass from a flower vase? etc.  
 Ask me questions about the water on the floor.  
 Ask me questions about the open window.  
 Ask me questions about how they died.*

### The solution

*Romeo and Juliet are goldfish. A cat came through the open window and tried to fish them out of the bowl with its paw. The bowl fell off the table and smashed on the floor. The cat leapt out of the window because of the noise, leaving Romeo and Juliet to die on the floor from suffocation.*

# OPPOSITES QUIZ

Find the opposite to these words.

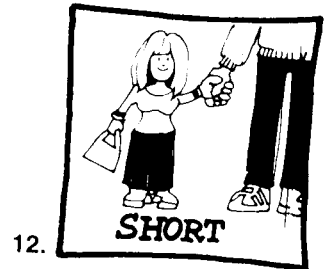
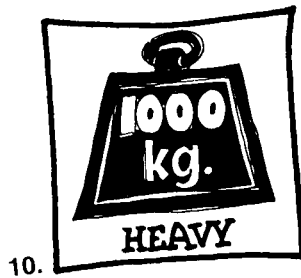
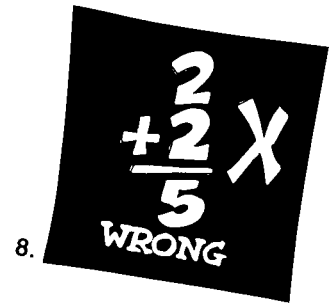
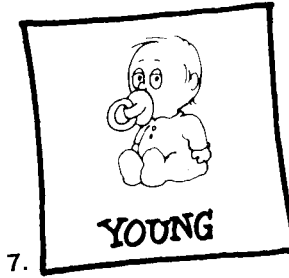
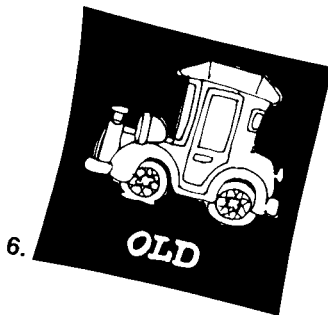
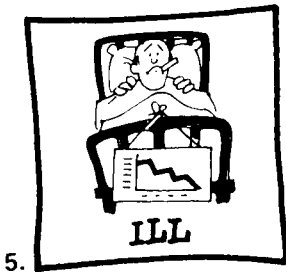
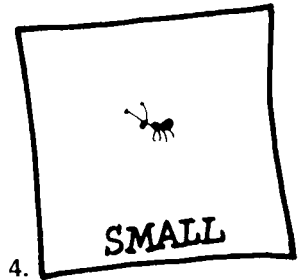

1. Happy / Sad

2. ....

3. ....

4. ....

5. ....

6. ....

7. ....

8. ....

9. ....

10. ....

11. ....

12. ....

## OPPOSITES QUIZ

**Adjectives:** *happy/sad*

Divide the class into small teams of two to three players and appoint team secretaries. Set a time limit of three to five minutes for the team secretaries, helped by the rest of their team, to write the opposites. The team with the most correct opposites is the winner.

<b>ANSWERS:</b>	1. happy/sad	7. young/old
	2. good/bad	8. wrong/right
	3. poor/rich	9. strong/weak
	4. small/big	10. heavy/light
	5. ill/well	11. cold/hot
	6. old/new	12. short/tall

## ADJECTIVES GAME

**Have got + Adjective + Noun:** *He's got a blue car.*

Write up the basic structure *He's got a/an ... car.* Begin the game by saying *He's got a blue car.* Explain that each player in turn has to say the same sentence but with a different adjective, for example:

Player 1: *He's got an old car.*  
 Player 2: *He's got a fast car.*  
 Player 3: *He's got a comfortable car.*

Players get minus points if they (a) are unable to think of a new adjective; (b) repeat an adjective which has been previously used; (c) use an inappropriate adjective; or (d) hesitate too long.

Example round with a group of five players:

Player 1: *He's got an old car.*  
 Player 2: *He's got a fast car.*  
 Player 3: *He's got a comfortable car.*  
 Player 4: *He's got ...*  
 (This player hesitates too long and so gets a minus point.)  
 Player 5: *He's got a slow car.*  
 Player 1: *He's got a new car.*

And so on. Start a new round of the game with a different base sentence and a different vocabulary area as soon as players begin to run out of ideas.

The player with the least number of minus points at the end of the game is the winner.

**Hints:** Suggestions for further games: *They've got a/an ... house; We've got a/an ... dog; She's got a/an ... coat; I've got a/an ... book.*

# SHADOWS

What are their jobs?



1.



2.



3.



4.



5.



6.



7.



8.



9.



10.

Use these words:

dentist

waitress

secretary

footballer

decorator

window cleaner

nurse

chef

teacher

gardener

1. He's a dentist.

2. They're footballers.

3. ....

4. ....

5. ....

6. ....

7. ....

8. ....

9. ....

10. ....

## SHADOWS

**Personal Pronouns + Verb to be** *He's a dentist.  
They're footballers.*

Divide the class into small teams of two to three players. Appoint team secretaries. Set a time limit of five minutes for the team secretaries, helped by the rest of their team, to write down what the various jobs are. The team with the most correct sentences is the winner.

- |                 |                         |                           |
|-----------------|-------------------------|---------------------------|
| <b>ANSWERS:</b> | 1. He's a dentist.      | 6. She's a nurse.         |
|                 | 2. They're footballers. | 7. He's a chef.           |
|                 | 3. He's a gardener.     | 8. He's a window cleaner. |
|                 | 4. She's a teacher.     | 9. They're waitresses.    |
|                 | 5. They're decorators.  | 10. They're secretaries.  |

## WHAT'S MY JOB?

**Verb to be + Personal Pronouns:** *Are you a doctor?  
Yes, I am./No, I'm not.*

Ask one of the players to write the name of a job on a slip of paper and hand it to you, without any of the other players seeing it. Mime an action which is associated with the job. Your mime does not have to be good, in fact it is better if you do not mime the job too clearly as this makes it too easy to guess what the job is. Then get the rest of the players to try to guess your job: *Are you a doctor? Are you a butcher?* Answer with *Yes, I am* or *No, I'm not*. Give further mime or verbal hints if the class find it impossible to guess, e.g. if you are a car mechanic say *garage*. You can also guide the class to the right answer by saying a definite *no* if they are way off the mark, and an encouraging *no* if they are getting warm. The player who guesses the right answer gets the chance to mime the next job for the others to guess, and so on, until everyone has had a turn.

**Hints:** Practise *Is he/Is she* questions by getting two players to think of a job; one then mimes an action associated with the job while the other answers the questions.

Encourage interesting jobs by suggesting jobs for the students to take on, e.g. *a window cleaner, a spy, a surgeon, an optician, an undertaker, a football referee, a farmer, a scientist.*

# THE NAME GAME

How many things can you name?

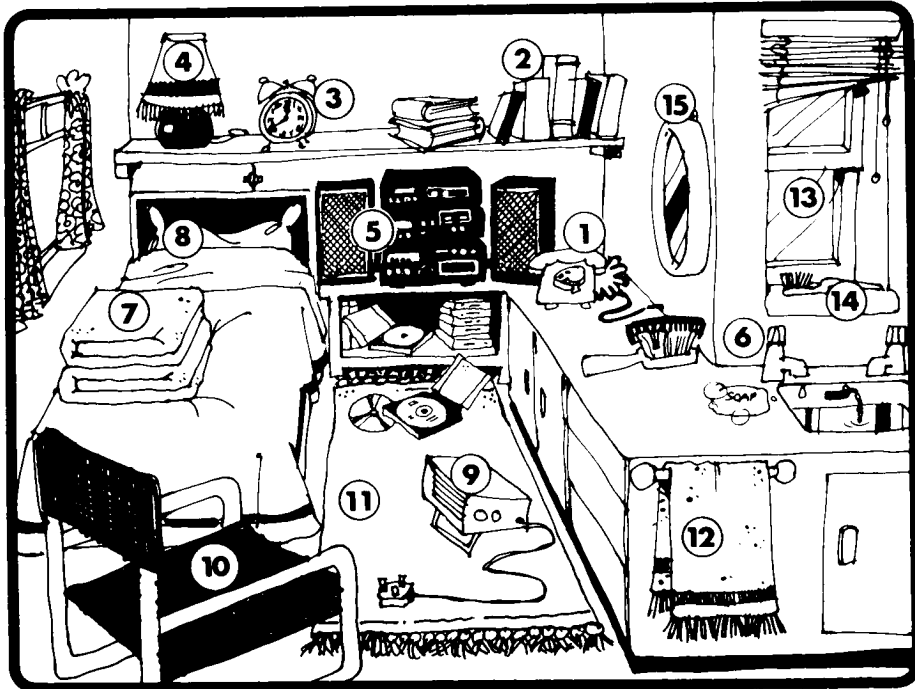
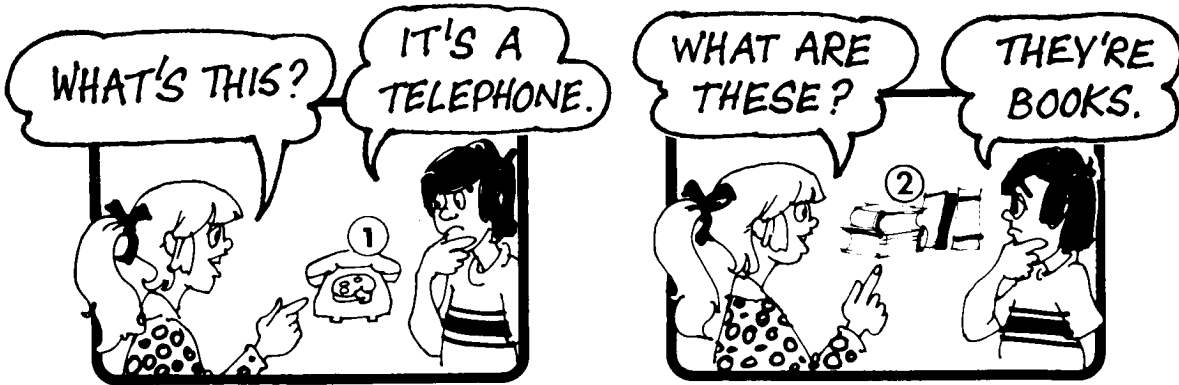

- 1. *It's a telephone.* .....
- 2. *They're books.* .....
- 3. ....
- 4. ....
- 5. ....
- 6. ....
- 7. ....
- 8. ....
- 9. ....
- 10. ....
- 11. ....
- 12. ....
- 13. ....
- 14. ....
- 15. ....



## THE NAME GAME

**Personal Pronouns + Verb to be:** *It's a telephone.  
They're books.*

**This/These:** *What's this? What are these?*

Divide the class into two teams (Team A and Team B). The two teams take it in turns to ask the other team *What's this?* and *What are these?* questions about the picture. For example:

Team A: (about object 3): *What's this?*  
Team B: *It's an alarm-clock.*  
Team B: (about object 4): *What's this?*  
Team A: *It's a light.*

The players in each team should take it in turns to ask and answer questions. Score 1 point per correct question, 2 points per correct answer. The team with the most points at the end is the winner.

- |                 |   |                        |
|-----------------|---|------------------------|
| <b>ANSWERS:</b> | 1. It's a telephone.                                | 8. It's a pillow.      |
|                 | 2. They're books.                                   | 9. It's a heater.      |
|                 | 3. It's an alarm clock.                             | 10. It's an armchair.  |
|                 | 4. It's a table lamp/a light.                       | 11. It's a rug/mat.    |
|                 | 5. It's a stereo system/<br>compact disc/CD player. | 12. It's a towel.      |
|                 | 6. It's a tap.                                      | 13. It's a window.     |
|                 | 7. They're blankets.                                | 14. It's a toothbrush. |
|                 |   | 15. It's a mirror.     |

### THE NAME GAME – extension

**This/That/These/Those:** *What's that? What are those?*  
**Personal Pronouns + Verb to be:** *It's a window.*

Continue as above but this time with questions about objects in the room.

Introduce the use of *this* and *these* for **near** and *that* and *those* for **far** singular and plural objects, by providing some example questions before playing the game.

**Hints:** You could make the vocabulary more interesting and varied by getting the players to place personal possessions in view.

# CATEGORIES 1

Put these words in the correct category.

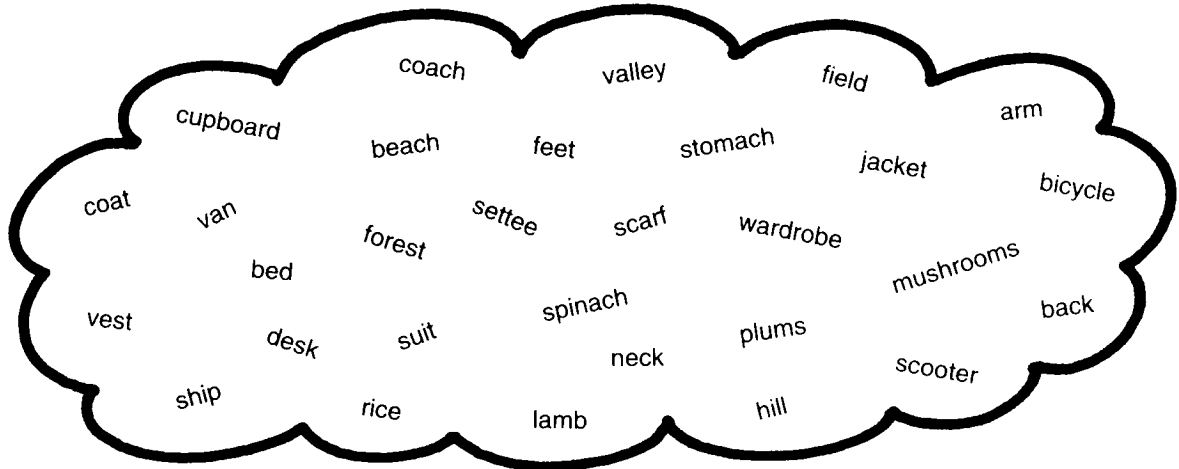

**FOOD**

rice

---

---

---

---

---

---

---

---

**CLOTHES**

---

---

---

---

---

---

---

---

**PARTS OF THE BODY**

---

---

---

---

---

---

---

---

**TRANSPORT**

---

---

---

---

---

---

---

---

**PLACES**

---

---

---

---

---

---

---

---

**FURNITURE**

---

---

---

---

---

---

---

---

## CATEGORIES 1

### Vocabulary

Working individually or in pairs, the players write the words under the appropriate category. The first player to do this correctly is the winner.

ANSWERS:	<b>Food:</b>	rice, spinach, lamb, plums, mushrooms.
	<b>Clothes:</b>	scarf, suit, vest, coat, jacket.
	<b>Parts of the body:</b>	stomach, neck, feet, back, arm.
	<b>Transport:</b>	van, ship, scooter, coach, bicycle.
	<b>Places:</b>	forest, hill, valley, field, beach.
	<b>Furniture:</b>	settee, bed, desk, cupboard, wardrobe.

## CATEGORIES 1 – extension

### Vocabulary

With the help of the class choose six categories, e.g. *colours, games/sports, animals, fruit/vegetables, jobs, materials*. Each player in turn chooses a letter of the alphabet. All the players then try to find and write down as many words as they can for each of the six categories beginning with the chosen letter. For example, if the chosen letter is *p*, a player might write down:

<u>Colours</u>	<u>Games/Sports</u>	<u>Animals</u>	<u>Fruit/Vegetables</u>	<u>Jobs</u>	<u>Materials</u>
<i>pink</i>	<i>polo</i>	<i>pig</i>	<i>plum</i>	<i>painter</i>	<i>plastic</i>
		<i>panda</i>	<i>pineapple</i>		
		<i>penguin</i>	<i>potato</i>		

Set a three-minute time limit. Each player then reads out his or her list of words. If a player has found a word not thought of by any of the other players, he scores 2 points. If, however, one or more of the other players has also thought of the same word, then they all score 1 point. The next player then begins the next round by choosing a different letter, and so on. The player with the highest total of points at the end of the final round is the winner.

## SOUTHAMPTON

### Vocabulary

Write up the word *Southampton*. Demonstrate how many words the word *Southampton* contains: *so, out, south, ham, am, amp, ton, on*. Write up another long word the class knows, e.g. *information*. Then working individually or in pairs the players write down as many words as they can find in the given word. The words must be of two letters or more. Set a two-minute time limit. The player with the most words is the winner. Continue with other long words.

## LAST IS FIRST

### Vocabulary

Choose a category in which the class knows a lot of words, e.g. *animals*. The first player calls out a word in that category. The next player then continues with another word in the category beginning with the last letter of the previous word, and so on, for example:

Player 1:	<i>Sheep.</i>
Player 2:	<i>Pig.</i>
Player 3:	<i>Giraffe.</i>
Player 4:	<i>Elephant.</i>

Players get minus points if they (a) are unable to think of a word in the category beginning with the last letter of the previous word; (b) repeat a word which has been previously used; or (c) hesitate too long. The player with the least number of minus points at the end of the game is the winner.

**Hints:** Play a trial round first. You could introduce the rule that whenever a player loses a point, the next player can begin with a new category. The category should be one in which the class knows a lot of words.

# DEFINITIONS

Find the correct definition for what these people do.



writes for a newspaper



repairs cars



looks after animals

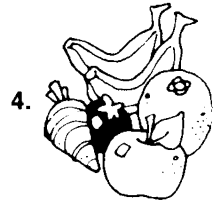

sells fruit and vegetables

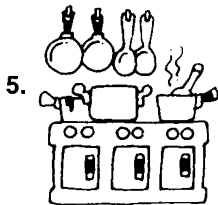

cooks in a restaurant



tests people's eyes



serves food in a restaurant



looks after small children



steals from people's homes



makes furniture out of wood

Use these words:

journalist

burglar

zoo keeper

waiter

greengrocer

au pair

optician

mechanic

chef

carpenter

1. *A journalist is someone who writes for a newspaper.*

2. ....

3. ....

4. ....

5. ....

6. ....

7. ....

8. ....

9. ....

10. ....

## DEFINITIONS

**Relative Pronoun (Who) + Present Simple:** *A journalist is someone who writes for a newspaper.*

Divide the class into two teams (Team A and Team B) and appoint team secretaries. The team secretaries, helped by the rest of their team, write the definitions of the various jobs. The first team to complete this is the winner.

**Hints:** You could extend this quiz by getting the two teams to write the names of eight more jobs for the other team to define. Check that the jobs they write are not too difficult and that there is no duplication of job titles.

- ANSWERS:
1. A journalist is someone who writes for a newspaper.
  2. A mechanic is someone who repairs cars.
  3. A zoo keeper is someone who looks after animals.
  4. A greengrocer is someone who sells fruit and vegetables.
  5. A chef is someone who cooks in a restaurant.
  6. An optician is someone who tests people's eyes.
  7. A waiter is someone who serves food in a restaurant.
  8. An au pair is someone who looks after small children.
  9. A burglar is someone who steals from people's homes.
  10. A carpenter is someone who makes furniture out of wood.

## CROSSWORD PUZZLES

**Relative Pronouns (Who/Where/That):** *Someone who employs people. A place where you live. Something that you tidy your hair with.*

Write two crossword puzzles on different pieces of paper. For example:

### Crossword A

```

1
C
1 B O S S 2          3
M 4 W 2 W I F E
3 B R E A D 5 L
I I P A
C 4 T Y P I S T
5 E Y E N
R
    
```

### Crossword B

```

1 2
S D
1 S C H O O L 3      4
O G O B
E 5 2 N U R S E
3 S H O P I A
I 4 O I L C
5 M I L K M A N H
L
    
```

Divide the class into two teams (Team A and Team B) and appoint team secretaries. Give a crossword puzzle to each of the teams and explain that they have to write clues for their puzzle like this:

- 1 Down: *Something that you tidy your hair with.*  
 1 Across: *Someone who employs people.*  
 2 Down: *Someone who works in a restaurant.*  
 2 Across: *Someone who has a husband.*  
 3 Down: *A place where you live.*  
 3 Across: *Something that you make sandwiches with.*

When they have finished writing the clues, they should draw a frame for their crossword and give the clues and the frame to the other team for them to try to solve. Example frame for **Crossword A**:

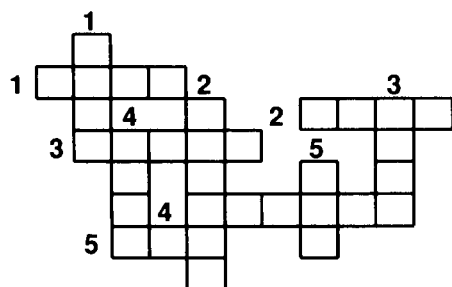

The two teams could then perhaps write and design their own crosswords for the other team to solve.

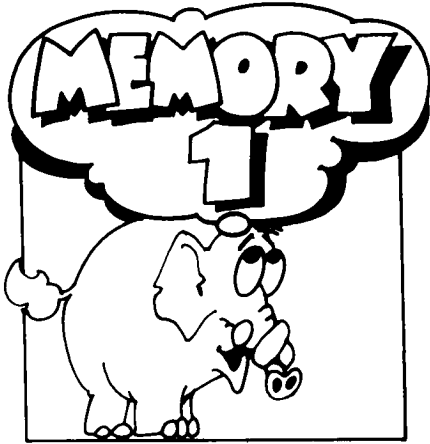

Look at this picture of a busy hospital ward. Try to remember what everyone is doing.



You have two minutes.



NOW ANSWER THE QUESTIONS ON THE SECOND PAGE.



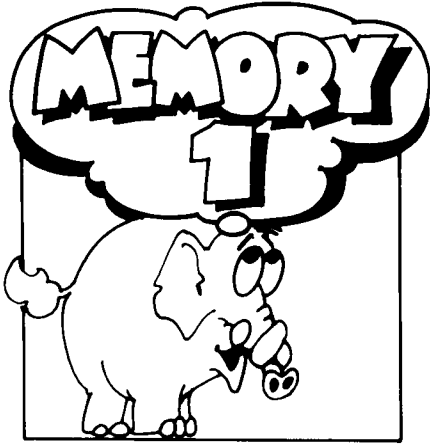

NOW COMPLETE THESE SENTENCES ABOUT THE HOSPITAL. DON'T LOOK AT THE FIRST PAGE AGAIN UNTIL YOU HAVE FINISHED.



1. A porter is fetching  
*them a screen.*



5. A patient is lending  
.....

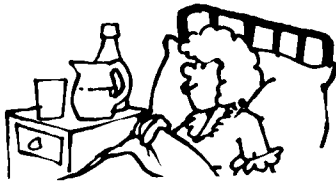

2. The matron is giving  
.....



6. A visitor is pouring  
.....



3. A visitor is bringing  
.....



7. A doctor is showing  
.....



4. A nurse is passing  
.....

Use these words:  
a thermometer      an injection      a screen      a glass of water      a pen      some flowers  
an X-ray

## MEMORY 1

**Present Continuous + Object Pronouns:** *A porter is fetching them a screen.*

**Photocopy pages 7 and 87 to play this game.**

Divide the class into small teams of two to three players and appoint team secretaries. Hand out page 7 and give the teams two minutes to study and memorise the picture. Then get the teams to cover or hand you back page 7. Hand out page 87 and go through the example with the class. The team secretaries, helped by the rest of their team, write down what the various people in the hospital ward are doing, using the picture prompts. Make sure they understand that each sentence should include an object pronoun. The team with the most correct sentences is the winner.

- |          |   |
|----------|---|
| ANSWERS: | 1. A porter is fetching them a screen.        |
|          | 2. The matron is giving her an injection.     |
|          | 3. A visitor is bringing her some flowers.    |
|          | 4. A nurse is passing him a thermometer.      |
|          | 5. A patient is lending her a pen.            |
|          | 6. A visitor is pouring him a glass of water. |
|          | 7. A doctor is showing them an X-ray.         |

## MIME GAME

**Present Continuous + Object Pronouns:** *Are you showing him a book?*

Tell the class that you are going to mime an action which they have to guess. Write the action on a piece of paper: *I'm showing him some holiday photos*. Choose a player to do the mime with and show him or her what is written on the piece of paper. Mime the action for the rest of the class to guess: *Are you showing him a book? Are you showing him a letter?* Get the player you are doing the mime with to answer their questions with *Yes, he/she is* or *No, he/she isn't*. (Your mime does not have to be good – the more amateur the mime, the more questions will have to be asked.) Give verbal hints if necessary and tell the class when they are getting warm. The player who guesses the mime then gets the chance to mime the next action for the others to guess, and so on, till everyone has had a turn.

Example actions: *I'm giving her a tip, I'm passing him the salt. I'm telling them a joke. I'm offering her a light. I'm showing them my passport photo. I'm fetching her a bandage. I'm asking him the way. I'm bringing them a drink.*

**Hints:** Make sure that when the players mime *pass*, *fetch* and *bring* they show the differences between these verbs.



# OPPOSITES QUIZ

Write the opposite of these words by adding these beginnings:

dis...

un...

im...

in...

1.

correct

2.

comfortable

3.

honest

4.

accurate

5.

expensive

6.

lucky

7.

polite

8.

satisfied

9.

sufficient

10.

possible

11.

fair

12.

patient

*incorrect*

1. ....
2. ....
3. ....
4. ....
5. ....
6. ....
7. ....
8. ....
9. ....
10. ....
11. ....
12. ....

## OPPOSITES QUIZ

**Adjective (Prefixes):** *incorrect, uncomfortable, dishonest*

Working individually, or in pairs, the players write the opposites of the adjectives using one of the four prefixes. The first player to do this correctly is the winner.

ANSWERS:	1. incorrect	5. inexpensive	9. insufficient
	2. uncomfortable	6. unlucky	10. impossible
	3. dishonest	7. impolite	11. unfair
	4. inaccurate	8. dissatisfied	12. impatient

## VOTING GAME

**Adjective (Prefixes):** *mispronounce, impersonal, indirect*

You will need a list of adjectives and verbs which take prefixes to play this game. For example, *(mis)pronounce, (im)personal, (in)direct, (un)conscious, (dis)agreeable, (il)logical*. Ask each player to write **MIS-**, **IN-**, **UN-**, **DIS-**, **IL-** in large capital letters, separately, on six pieces of paper. Explain that you are going to call out a number of words and that after each one, the players should vote which prefix should be used by holding up the appropriate piece of paper. They should all vote in unison and not look at what the others are doing before deciding. Players get a minus point if they (a) hold up the wrong prefix; or (b) hesitate too long. Begin to read out your list of words, pausing after each one for the players to vote on which prefix to use. The player with the least number of minus points at the end is the winner.

**Hints:** Play a trial round first.

Example word list (adapt to the knowledge of your class):

**Mis** – *pronounce, interpret, behave, understand, spell, calculate, represent*

**Im** – *personal, moral, proper, probably, mortal, perfect, plausible, practical*

**In** – *direct, dependent, complete, adequate, competent, efficient, experienced*

**Un** – *conscious, certain, equal, fashionable, fit, clean, aware, answered*

**Dis** – *agreeable, approve, organise, like, obey, pleased, content, believe, order*

**Il** – *logical, literate, legal, legible*

# THE NAME GAME

How many things can you name?

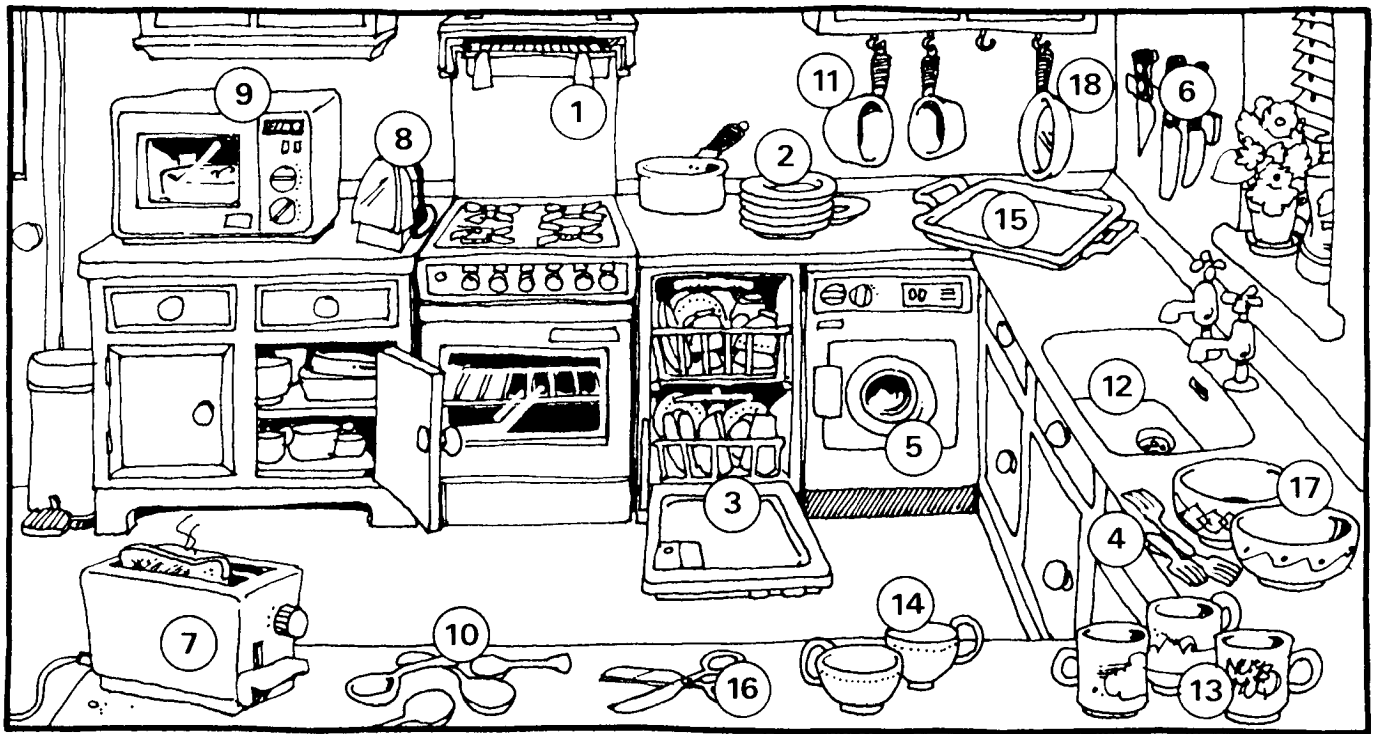
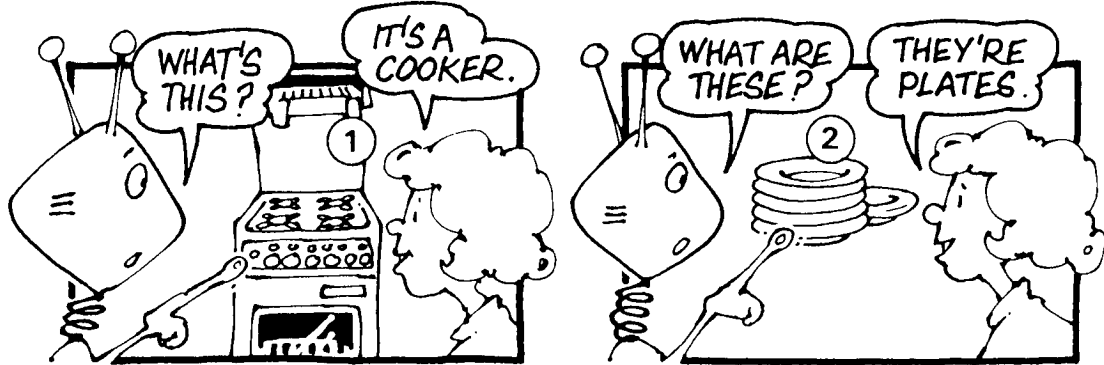

- |                    |          |
|--------------------|----------|
| 1. It's a cooker.  | 10. .... |
| 2. They're plates. | 11. .... |
| 3. ....            | 12. .... |
| 4. ....            | 13. .... |
| 5. ....            | 14. .... |
| 6. ....            | 15. .... |
| 7. ....            | 16. .... |
| 8. ....            | 17. .... |
| 9. ....            | 18. .... |

## THE NAME GAME

**Verb to be:** *What's this? It's a cooker.*  
**This/These** *What are these? They're plates.*  
**Singular and Plural Nouns**

Divide the class into small teams of two to three players and appoint team secretaries. The team secretaries, helped by the rest of their team, write down all the things they can identify in English. Set a five minute time limit for them to complete this task. At the end, the team with the most correct answers is the winner.

**Hints:** Practice *What's this?/What are these?* questions afterwards by getting students to ask and answer about the objects in the picture.

- |          |                            |                        |
|----------|----------------------------|------------------------|
| ANSWERS: | 1. It's a cooker.          | 10. They're spoons.    |
|          | 2. They're plates.         | 11. They're saucepans. |
|          | 3. It's a dishwasher.      | 12. It's a sink.       |
|          | 4. They're forks.          | 13. They're mugs.      |
|          | 5. It's a washing machine. | 14. They're cups.      |
|          | 6. They're knives.         | 15. It's a tray.       |
|          | 7. It's a toaster.         | 16. They're scissors.  |
|          | 8. It's an iron.           | 17. They're bowls.     |
|          | 9. It's a microwave oven.  | 18. It's a frying pan. |

### THE NAME GAME – extension

**Verb to be:** *What's this? It's a lighter.*  
**This/These:** *What are these? They're batteries.*  
**Singular and Plural Nouns**

Working in small teams of two or three players, get the students to put together a collection of ten objects made up of their personal possessions, e.g. *a lighter, two batteries, a hair slide, two safety pins, a penknife, two combs, a business card, two cassettes, a pencil sharpener, a watch strap*. While they are doing this, go round the class and check that there is not too much duplication of objects and that the things chosen are neither too obscure nor too easy. The students then have to write a list of their objects in English. If necessary, they could use dictionaries to help them do this or ask you. Each team then challenges the class to name their objects. They should do this by holding up each object in turn and asking *What's this?* or *What are these?* The teams should write their answers down (*It's/They're ...*) after consultation with their fellow team members. Award team totals (1 point per correct answer) after each round.

**Hints:** This game could be made easier by getting the teams to give the initial letter(s) of the object when they ask their questions, e.g. *What's this? It begins with an L. What are these? They begin with a B.*

# CATEGORIES 1

Put these adjectives in the correct category.

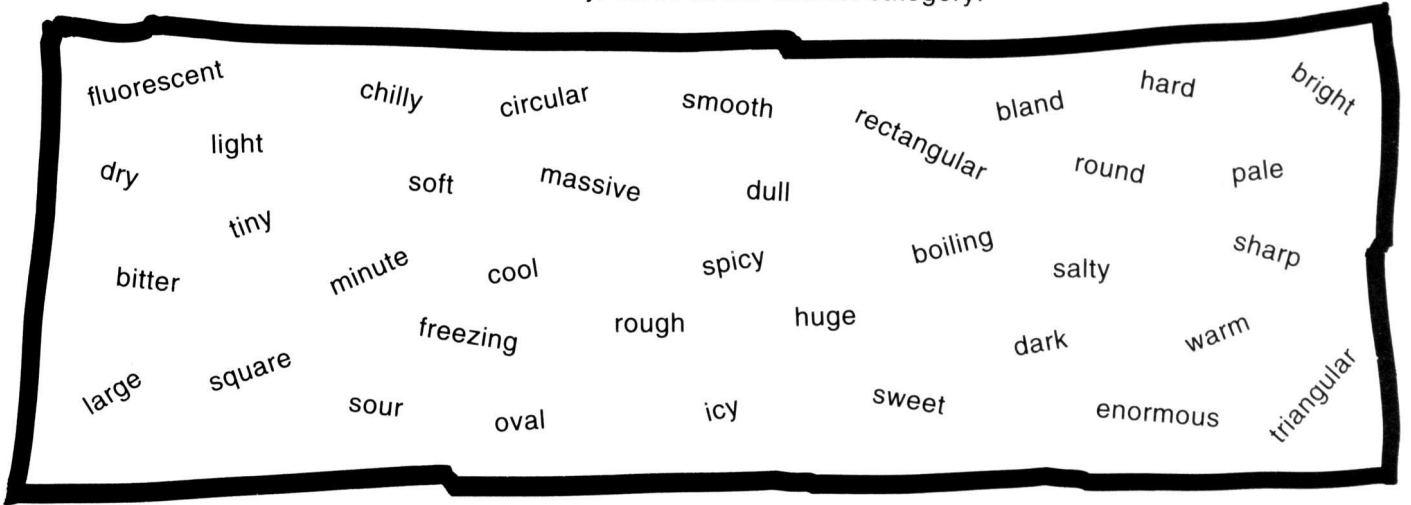

**Temperature**

*freezing*



**Texture**



**Shape**



**Size**



**Taste**



**Colour**

## CATEGORIES 1

**Adjectives:** *freezing, cool, boiling*

Divide the class into teams of two to three players. Appoint team secretaries. The team secretaries, helped by the rest of their team, write the adjectives under the appropriate heading. The first team to correctly categorise the words is the winner.

**Hints:** When the teams read out their answers you could ask them to put each adjective into a sentence which illustrates the meaning of the word. For example:

*There was a freezing wind and ice everywhere.  
The weather isn't cold, but it is a little cool.*

ANSWERS:	Temperature	Texture	Shape	Size	Taste	Colour
	freezing	rough	rectangular	huge	sour	light
	cool	smooth	oval	minute	bitter	bright
	boiling	hard	square	tiny	sweet	pale
	icy	soft	circular	enormous	spicy	dark
	warm	dry	round	large	salty	fluorescent
	chilly	sharp	triangular	massive	bland	dull

## CATEGORIES 1 – extension

**Adjectives (Describing people):** *old, heavy, slim*

Write up the following categories: *age, weight, build, hair colour, personality, looks, height, intelligence, skin colouring.*

Tell the team secretaries to write down the category headings and then, with the help of the rest of their team, write as many adjectives as they can think of under each heading. For example:

<b>Age</b>	<b>Weight</b>	<b>Build</b>	<b>Hair colour</b>	<b>Personality</b>
<i>old</i>	<i>heavy</i>	<i>slim</i>	<i>blond</i>	<i>kind</i>
<i>young</i>	<i>light</i>	<i>thin</i>	<i>dark</i>	<i>generous</i>

Set a ten-minute time limit.

Each team then reads out their lists of adjectives. The team secretaries should cross out any duplicate adjectives on their lists which are read out by another team. At the end the team with the most adjectives left is the winner. Check that the adjectives are appropriate for the heading.

## DESCRIPTION GAME

**Adjectives (Describing objects):** *It has got a long stick.*

Tell the class that you are going to read out a description for them to guess what it is. Begin to read the description. For example:

*It has got a long stick. The stick is usually made of metal and it has got a curved end which forms a handle. The handle is usually made of wood or plastic. On the top of the stick is a metal frame. The frame is covered with material, usually cotton or a synthetic fabric. This material is waterproofed. What is it? (An umbrella)*

Divide the class into teams of two to three players. Appoint team secretaries.

The team secretaries, with the help of the rest of their team, have to write a similar description for a different object. Help them with their descriptions if necessary.

Collect all the finished descriptions and begin to read them out. The teams then have to guess what the objects described by the other teams are. Each team has only one guess. They can either interrupt you as the description is being read out or guess at the end when you have finished reading it. The first team to guess what the object is scores 1 point. At the end, the team with the most points is the winner.

**Hints:** You could extend this game by getting the teams to write descriptions of well-known personalities for the other teams to guess.

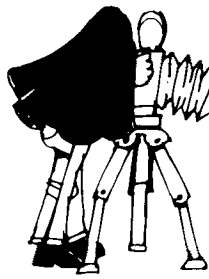

# CLOSE-UPS

What is this man having done?

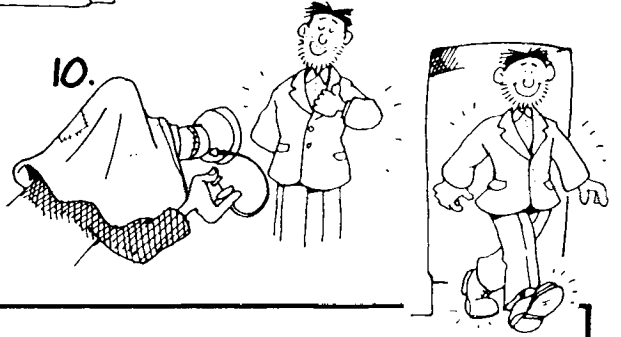
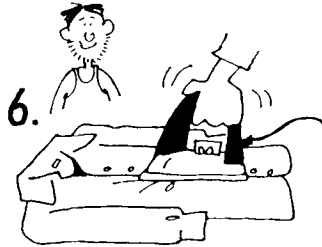
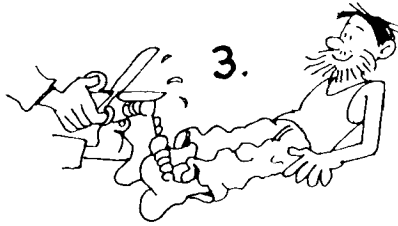

Use these verbs:      press      cut      mend      massage  
 test      take      dry clean      trim      polish      dye

1. He's having his hair dyed.
2. ....
3. ....
4. ....
5. ....
6. ....
7. ....
8. ....
9. ....
10. ....

## CLOSE UPS

**Have something done:** *He's having his hair dyed.*

Go through the example with the whole class. Point out the passive form *have + object + past participle*. Then divide the class into teams of two to three players and appoint team secretaries. The team secretaries, helped by the rest of their team, then write sentences about each picture using the verbs in the box. The winner is the first team to do this correctly.

ANSWERS:

- |                                   |                                       |
|-----------------------------------|---------------------------------------|
| 2. He's having his back massaged. | 6. He's having his shirt pressed.     |
| 3. He's having his toenails cut.  | 7. He's having his shoes polished.    |
| 4. He's having his beard trimmed. | 8. He's having his socks mended.      |
| 5. He's having his eyes tested.   | 9. He's having his suit dry cleaned.  |
|                                   | 10. He's having his photograph taken. |

## INVENTION GAME

**Have something done (or Get something done):**  
*I need to have the brakes adjusted.*

Prepare some descriptions about different things using the structure *have (or get) + object + past participle*. For example:

*There are lots of things wrong with it. I need to have the brakes adjusted. I also need to have the clutch repaired and a new windscreen wiper fitted.*

Explain that you are going to read out some descriptions and that the teams have to guess what object you are talking about. Read out the first description as an example:

*There are lots of things wrong with it. I need to have the brakes adjusted. I also need to have the clutch repaired and a new windscreen wiper fitted. What am I talking about?*

Get the class to guess that you are talking about your car.

Divide the class into teams of two to three players and appoint team secretaries. The team secretaries, helped by the rest of their team, have to write down the name of the object you are talking about. Begin to read out your descriptions stopping after each one for the teams to discuss and write down their answer. The winning team is the one that guesses the most objects.

**Example descriptions:** (Adapt to the level of your class.)

*There are lots of things wrong with it. I need to have the brakes adjusted. I also need to have the clutch repaired and a new windscreen wiper fitted. (a car)*

*I had it dyed black. It was a really horrible colour before. I also had some new buttons put on and the sleeves shortened. (a coat, cardigan, or jacket)*

*I should have the roof repaired. I also need to have the plumbing ripped out and completely replaced and then I must have the whole place repainted. (a house)*

*You should have the front tyre repaired. Two spokes in the back wheel are broken so you should have those replaced. Also, you should have the saddle raised. It's too low for you at the moment. (a bicycle)*

*You could have it permed, I suppose. Or you could have it cut short. That might look nice. (hair)*

*I'm having it developed at the moment. Then I'm going to have them all enlarged and framed. (a film, photographs)*

*I had two extracted and three filled. Then I had them all cleaned and polished. Don't they look nice? (teeth)*



# CONNECTIONS 7

Match the phrasal verbs with the pictures. Then complete the questions with the correct form of the verb.

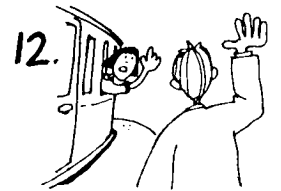
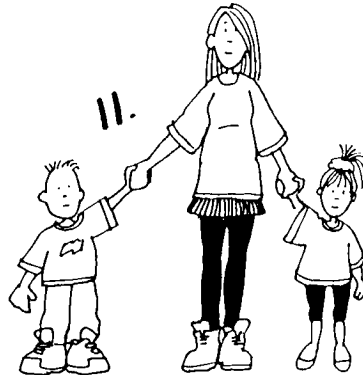
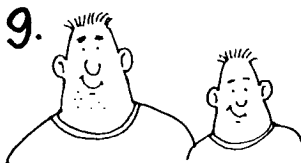
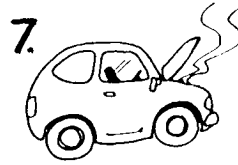
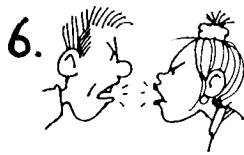
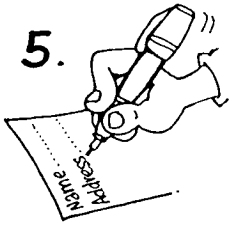
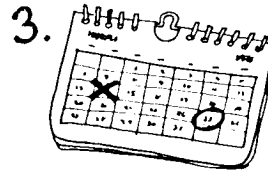
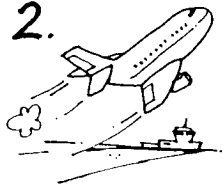
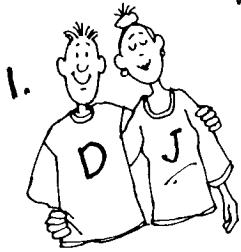

- |          |             |            |            |          |
|----------|-------------|------------|------------|----------|
| fall out | go out with | pass away  | see off    | tell off |
| fill in  | look after  | break down | put off    | take off |
|          |             |            | take after | wake up  |

- Who is Danny *going out with* .....? – Julia.
- What time did the plane .....? – At 12.30.
- Why have you ..... your dental appointment tomorrow? – Because I'm too busy.
- What time are you going to ..... tomorrow morning? – At 7.00.
- Have you ..... the form? – Yes, I have.
- Why has Julia ..... with Danny? – Because he was rude to her.
- Why did your car .....? – It ran out of petrol.
- Are you going to ..... the children? – Yes.
- Do you ..... your father or your mother? – My father.
- When did your grandfather .....? – Last year.
- Can you ..... my children for half an hour? – Of course.
- Can I ..... you ..... at the station? – No, let's say goodbye here.

## CONNECTIONS 7

### Phrasal Verbs: Who is Danny going out with?

Go through the example with the whole class. Then, working individually or in teams of two to three, the players match the pictures with the phrasal verbs in the box. They should then complete the questions with the correct form of the phrasal verbs. Set an eight-minute time limit to complete the game. The player/team with the most correct sentences is the winner.

- ANSWERS:
2. What time did the plane take off?
  3. Why have you put off your dental appointment?
  4. What time are you going to wake up tomorrow morning?
  5. Have you filled in the form?
  6. Why has Julia fallen out with Danny?
  7. Why did your car break down?
  8. Are you going to tell off the children?
  9. Do you take after your father or your mother?
  10. When did your grandfather pass away?
  11. Can you look after my children for half an hour?
  12. Can I see you off at the station?

## DRAWING GAME

### Phrasal Verbs: throw away, look forward to, grow up

Draw up a list of phrasal verbs appropriate to the level of your students. Ideally, these phrasal verbs should be taken from teaching materials (texts, dialogues, etc.) used in past lessons with your students. As an example, write up a list of five of these phrasal verbs on the board. Number these verbs 1–5. Then draw – in jumbled order – simple blackboard drawings representing these verbs alongside them. Label these drawings A–E. Then ask the class, working in teams of two or three, to match your drawings with the verbs in the list. For example:

1. run over

2. grow up

3. throw away

4. give up

5. look forward to

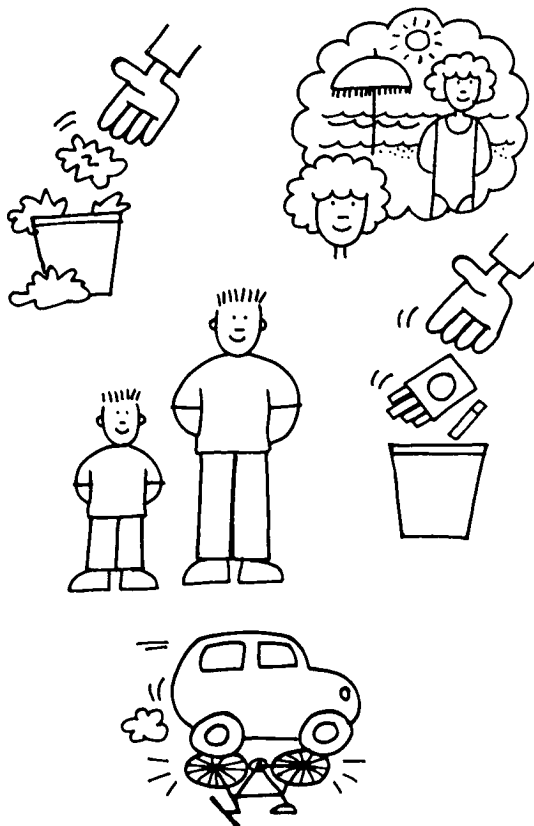

Then give a list of five different phrasal verbs to each team. Get the teams to copy this list on a separate piece of paper and draw a picture in jumbled order representing each verb in their list as you did in the example. Go round the class helping with comprehension and ideas as they do this.

Then get the teams to exchange papers and match the drawings with the phrasal verbs. Teams win 1 point for each verb they guess.



# AIRPORT TALK



Who is saying what? Write the letters (A - M) in the correct speech balloons.

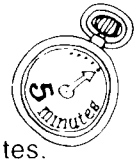
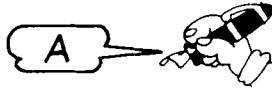

Then try to memorise what each person says. You have five minutes.

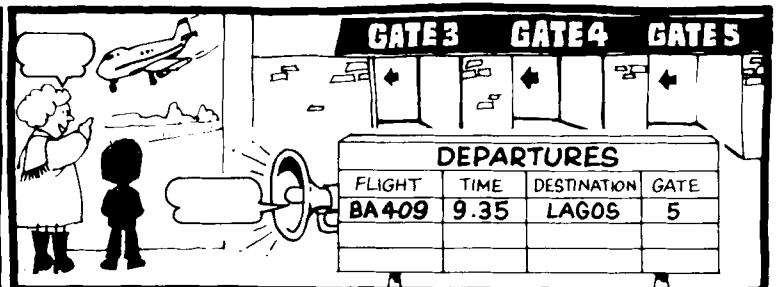

NOW LOOK AT THE SECOND PAGE.

ALL PASSENGERS TO LAGOS SHOULD GO IMMEDIATELY TO GATE FIVE.

YOU CAN WAIT BY THE CHECK-IN COUNTER.

I COME FROM AUSTRALIA.

GOODBYE. DON'T FORGET TO WRITE.

I HAVEN'T GOT ANYTHING IN MY BAG.

WALK THROUGH THE DOOR, PLEASE.

WE OUGHT TO HURRY.

I HAD AN ACCIDENT.

LOOK, IT'S GOING TO LAND.

I'M STAYING FOR TWO WEEKS.

...YES, I'VE JUST ARRIVED AT THE AIRPORT.

I WAS VERY AFRAID.

I'LL FETCH A TROLLEY.

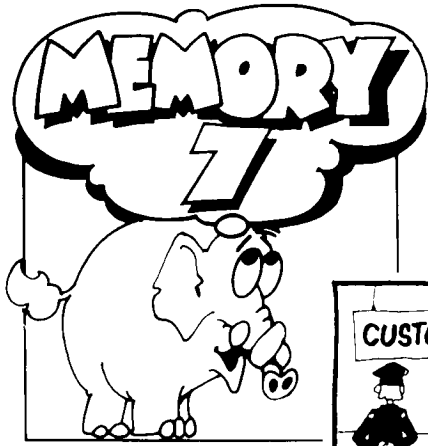

WHAT DID THE PEOPLE AT THE AIRPORT SAY TO EACH OTHER?

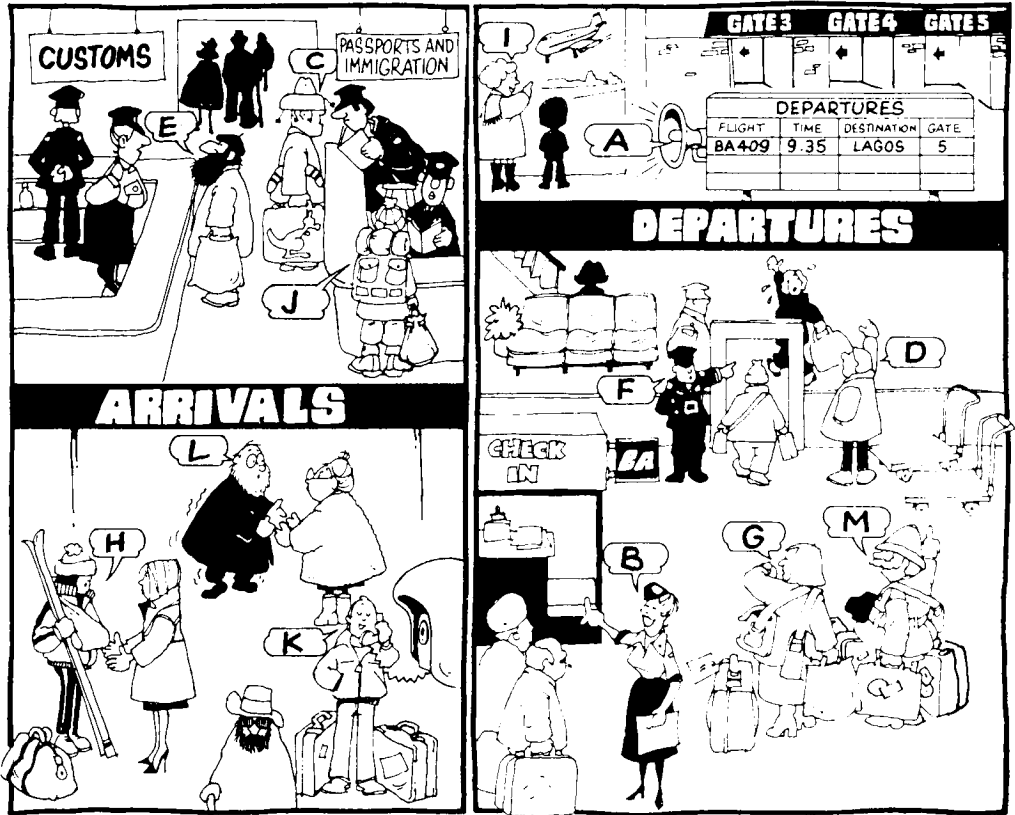

- A. The announcement said all passengers to Lagos  
*should go immediately to Gate Five.*

---

- B. The stewardess said they .....
- C. The passenger said he .....
- D. The young man reminded her not .....
- E. The man with the beard said .....
- F. The security officer told him to .....
- G. The wife said they .....
- H. The girl explained that she .....
- I. The mother said the plane .....
- J. The man with the rucksack told him .....
- K. The young man said he .....
- L. The old man said he .....
- M. The husband said he .....

## MEMORY 7

**Reported Speech:** *The announcement said all passengers to Lagos should go immediately to Gate Five.*

**Photocopy pages 59 and 93 to play this game.**

Divide the class into teams of two to three players. Appoint team secretaries. Hand out page 59. The team secretaries, helped by the rest of their team, write the letters A–M in the correct speech balloons. Then get the teams to cover or hand you back page 59. Hand out page 93. They then look at this second page and write down what the various people at the airport said, using the prompts. They must not look back at the first page while doing this.

The team with the most correct sentences is the winner.

- |          |  |   |
|----------|--|---|
| ANSWERS: | A. The announcement said all passengers to Lagos should go immediately to Gate Five. | G. The wife said they ought to hurry.                               |
|          | B. The stewardess said they could wait by the check-in counter.                      | H. The girl explained that she had had an accident.                 |
|          | C. The passenger said he came from Australia.  | I. The mother said the plane was going to land.                     |
|          | D. The young man reminded her not to forget to write.                                | J. The man with the rucksack told him he was staying for two weeks. |
|          | E. The man with the beard said he hadn't got anything in his bag.                    | K. The young man said he had just arrived at the airport.           |
|          | F. The security officer told him to walk through the door.                           | L. The old man said he had been very afraid.                        |
|          |  | M. The husband said he would fetch a trolley.                       |

## BUSH-TELEGRAPH

**Reported Speech:** *You said you didn't feel very well.*

Begin by saying *I don't feel very well*. Explain that the first player has to report what you said and then say something new for the next player to remember and report, e.g. *You said you didn't feel very well. I feel fine*. The game continues in this way with each player in turn trying to remember what the other players said and then saying something new.

Players get a minus point if they (a) make a memory mistake; or (b) hesitate too long.

Example round with a group of five players:

Player 1: *You said you didn't feel very well. I feel fine.*

Player 2: *You said you didn't feel very well. You said you felt fine. I felt fine until a moment ago.*

Player 3: *You said you didn't feel very well. You said you felt fine. You said you had felt fine until a moment ago. I'm going out.*

Player 4: *You said ...*

*(This player cannot remember what follows and gets a minus point.)*

Player 5: *(beginning again) I'm very happy.*

Player 1: *You said you were very happy. I'll be glad when this lesson is over.*

And so on.

At the end, the players with the least number of minus points are the winners.

**Hints:** Play a trial round first.



## OBSERVATION 4

**Passive – Had been done:** *Rock'n'roll hadn't been thought of yet.*

Divide the class into teams of two to three players. Appoint team secretaries. The team secretaries, helped by the rest of their team, write down five more sentences pointing out the deliberate mistakes in the picture. The first team to do this correctly is the winner.

ANSWERS: The atomic bomb hadn't been invented yet. (1945)  
*The Sound of Music* hadn't been made yet. (1965)  
 Penicillin hadn't been developed yet. (1940)  
*Guernica* hadn't been painted yet. (by Pablo Picasso 1937)  
 Mohammed Ali (Cassius Clay) hadn't been born yet. (1950)

### OBSERVATION 4 – extension

**Passive – Had been done:** *The Arc de Triomphe hadn't been built yet.*

You will need a number of stories with a historical setting for this game. Tell the class that you are going to tell them a story about Napoleon which contains a number of deliberate mistakes. The players should listen to the story and interrupt you whenever they spot a mistake. Begin to read the story:

*It was the year 1811. Napoleon looked out of the windows of his state room which overlooked all Paris. In front of him he could see the Arc de Triomphe reminding him of all his great victories. On the horizon was the Eiffel Tower. 'Why didn't Eiffel call it the Napoleon Tower?', thought Napoleon. He picked up a gold telescope lying on the table next to him. 'Perhaps I can see Josephine,' he murmured. 'No, she must have gone to see one of those new-fangled Lumière brothers' cinematographs,' he thought as he scanned the palace for signs of Josephine. He looked at the picture of George Washington on the wall. 'Did he have the same problems as me?' he wondered. He picked up a book and switched on his desk light. It was 'War and Peace'. Napoleon loved to read books which were about war. 'If only it was called "War and War",' he thought. 'Now that would be a book' The telephone rang. 'Ah, well. Back to business! I suppose that's Marshal Ney with the latest news about the Battle of Waterloo,' he speculated.*

And so on, with the players coming in with interruptions such as:

*The Arc de Triomphe hadn't been built yet.  
 Eiffel hadn't been born yet.  
 The cinematograph hadn't been invented yet.*

(Other deliberate mistakes: *electric light/invented, War and Peace/written, telephone/invented, Battle of Waterloo/fought.*)

**Hints:** You could get teams of players to write similar stories to test the rest of the group's historical knowledge.

# True or False?

Why is a sandwich called a sandwich?  
Only one of these stories is true. Which is it?

Put a  in the box next to the true story.



English people love picnics. They like eating in the countryside, in parks and even on the beach. The only problem about eating on the beach is that the sand often gets into the food. One day someone had the very good idea of putting the meat or cheese between two slices of bread. This stopped the sand from getting onto the food. It is because of this that today we call sandwiches 'sandwiches'.

A.

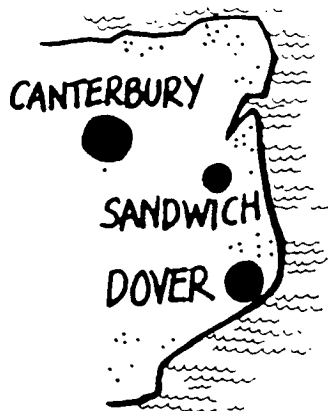

The town of Sandwich is situated between Dover and Canterbury in south-east England. Sandwich is a very small town when you compare it with either Dover or Canterbury but the people who live there have always considered that it is a more important and better town to live in than either of the other two larger towns. One day a Sandwich man was sitting having lunch with a man from Dover and a man from Canterbury. The Sandwich man put a thick slice of bread on the table and said, 'This piece of bread is Canterbury'. Then he put another thick slice of bread on top of the first slice and said, 'And this is Dover'. Then he picked up a piece of cheese, put it between the two slices of bread and said, 'But this tasty piece of cheese is Sandwich'. It is because of this man that today we call sandwiches 'sandwiches'.

B.

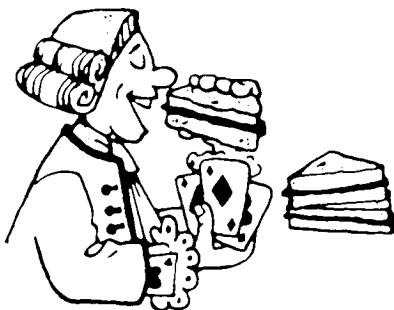

An eighteenth-century English aristocrat, the Earl of Sandwich, loved playing cards. He used to play cards all day and night and hated having to stop a game for his meals. One day he thought of a way of putting meat between two slices of bread. In this way he could eat while at the same time continue playing cards. It is because of the Earl of Sandwich that today we call sandwiches 'sandwiches'.

C.



## TRUE OR FALSE?

### Comprehension

Working individually or in pairs, the players read the three possible explanations and decide which is the true one.

ANSWER: The true story is C.

## TRUE OR FALSE – extension

### Comprehension

You could extend this game by making up or finding interesting derivations of words and then reading them to the players who have to decide whether the explanation is true or false. For example:

*The word 'news' comes from the initial letters of the words 'north', 'east', 'west', 'south'. This is because it is the latest information coming in from the four points of the compass.*

*(False: It comes from the old French word 'noveles'.)*

*The expression 'OK' comes from the initials of a Mr Otto Keiser who worked for the Ford Motor Company in the USA in the early part of this century. Mr Keiser worked as chief checker for Ford and his job consisted of standing at the end of the assembly line checking that the newly finished cars were road-worthy. Mr Keiser had the habit of chalking his initials on the cars that passed his tests. And in time these initials 'OK' have come to mean OK.*

*(False: There are many theories for the derivation of 'OK' but this is certainly not one of them.)*

*Cardigans are named after the British nobleman, the Earl of Cardigan who began the fashion for wearing this garment in his efforts to try to keep warm while fighting in the Crimean War.*

*(True)*

The players, working individually or in pairs, and with the aid of dictionaries, could then write similar true and false derivations for the rest of the class to guess.

# CONNECTIONS 1

What are these people saying on the phone? Match the people with the sentences below.



1. I've lost my car keys.
2. I've bought a new skirt.
3. I've been to the dentist's.
4. I've hurt myself.
5. I've found a job.
6. I've passed my exam.
7. I've had a big argument with my boyfriend.
8. I've broken my glasses.

Then complete the sentences.

Use these verbs:

buy      cut      have      hurt      find      get      go to  
 be      break      pass      cost      say      see      walk      lose

1. **A** | I've lost ..... my car keys. They **were** ..... in my bag.
2. [ ] | ..... a new skirt. It only ..... £16.
3. [ ] | ..... to the dentist's. I ..... two fillings.
4. [ ] | ..... myself. I ..... my hand on a tin.
5. [ ] | ..... a job. I ..... notice in the paper.
6. [ ] | ..... my exam. I ..... 98 out of 100!
7. [ ] | ..... a big argument with my boyfriend. He ..... I was stupid.
8. [ ] | ..... my glasses. I ..... into a wall.

## CONNECTIONS 1

**Present Perfect Simple:** *I've lost my car keys.*

**Past Simple:** *They were in my bag.*

Go through the example with the whole class. Then, working individually or in teams of two to three, the players match the people in the pictures with the sentences they are saying. They should then complete the sentences with the present perfect simple or the past simple of the verbs in the box. Set a ten-minute time limit to complete the game. The player/team with the most correct sentences is the winner.

- ANSWERS:
1. A I've lost my car keys. They were in my bag.
  2. H I've bought a new skirt. It only cost £16.
  3. D I've been to the dentist's. I had two fillings.
  4. C I've hurt myself. I cut my hand on a tin.
  5. E I've found a job. I saw a notice in the paper.
  6. G I've passed my exam. I got 98 out of 100!
  7. F I've had a big argument with my boyfriend. He said I was stupid.
  8. B I've broken my glasses. I walked into a wall.

## NEWS QUIZ

**Present Perfect Simple:** *Someone I know has grown a moustache.*

**Past Simple:** *It took him weeks to grow.*

**Present Tenses:** *He thinks he looks much more handsome with it.*

Prepare a list of news items with one or two sentences about each one giving more detailed information about the news, e.g. *Someone I know has grown a moustache. It took him weeks to grow. He thinks he looks much more handsome with it.*

Divide the class into teams of two to three players and appoint team secretaries. Explain to the class that they have to guess what news has happened from some information you are going to give them. Give one or two examples before playing the game. Say, for example, *It took him weeks to grow. He thinks he looks really handsome with it.* Then allow time for the teams to discuss what the news could be and for the team secretaries to write down their answer using the present perfect simple.

Play the game, awarding 1 point to teams guessing the correct answer.

**Example news items:**

*Someone I know has just lost her job. She had an argument with her boss and her boss gave her two weeks' notice.*

*Someone I know has just won a prize in the lottery. It was the first time he'd bought a ticket. He's going to spend the money on a new car.*

*Someone I know has fallen madly in love. He can't sleep at night since he met her at a party and talks about her all the time.*

*Someone I know has just had an operation. He had to have a general anaesthetic and he's still in hospital.*

*Someone I know has just had her flat burgled. They got in a window and took her video and CD player.*

*Someone I know has just split up with her boyfriend. He was seeing another woman. She's feeling very sad but is pleased that it's all over between them.*

*Someone I know has just passed his examination. He is really surprised because he only started revising at the last moment.*

*Someone I know has lost a lot of weight. He was ill for a long time and didn't feel like eating.*

Your students could then invent news items for the rest of the class to guess.

# DIFFERENCES 2

Write these American English expressions under the pictures.

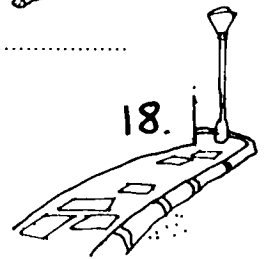
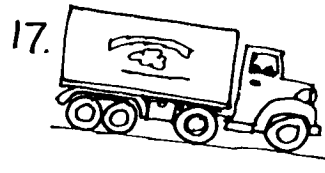
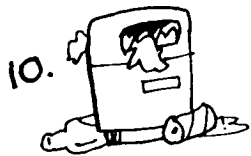
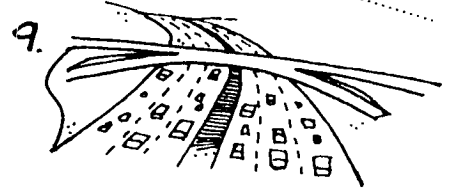
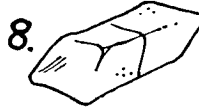
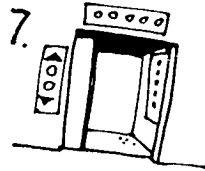
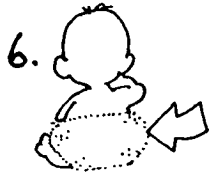
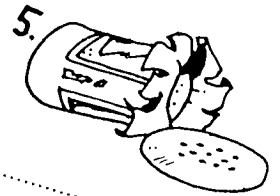
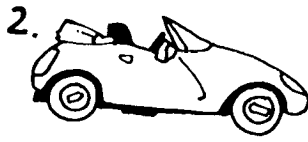

automobile	expressway	apartment	truck	purse
pants	rest room	candy	diaper	eraser
	can	shorts	garbage can	movie
		cookie	elevator	sidewalk
				panty-hose

Now connect the American expressions with their British English equivalents.

- A. car ..... *automobile* .....
- B. tights .....
- C. handbag .....
- D. lift .....
- E. flat .....
- F. biscuit .....
- G. trousers .....
- H. public toilet .....
- I. nappy .....

- J. film .....
- K. rubbish bin .....
- L. pavement .....
- M. sweet .....
- N. lorry .....
- O. pants .....
- P. tin .....
- Q. motorway .....
- R. rubber .....

## DIFFERENCES 2

### American and British English; Vocabulary: *car, automobile*

Go through the example with the whole class. Then divide the class into teams of two to three players and appoint team secretaries. The team secretaries, with the help of the rest of their team, first write the American English expressions under the correct pictures and then match these expressions with their British English equivalent. The first team to do this correctly is the winner.

ANSWERS:	1. apartment – E	10. garbage can – K
	2. automobile – A	11. movie – J
	3. can – P	12. pants – G
	4. candy – M	13. panty-hose – B
	5. cookie – F	14. purse – C
	6. diaper – I	15. rest room – H
	7. elevator – D	16. shorts – O
	8. eraser – R	17. truck – N
	9. expressway – Q	18. sidewalk – L

### WHAT ARE THEY TALKING ABOUT?

### American and British English; Vocabulary: *faucet, tap*

Divide the class into teams of two to three players and appoint team secretaries. Explain that you are going to read out some sentences containing two American English expressions which have different British English equivalents and that the teams have to guess what is being talked about and try to write down the British English equivalents. Work through one or two examples with the whole class. Then begin to read out the sentences getting the team secretaries, helped by the rest of their team, to write down their ideas. Give the teams time to discuss and write down their answers before going on to the next sentence.

Award 1 point for each correct British English equivalent. The winning team is the one with the most points at the end.

#### Example sentences:

*One of the faucets won't work on the tub.  
(One of the taps won't work on the bath.)*  
*First the fender fell off and then I couldn't open the trunk.  
(First the bumper fell off (the car) and then I couldn't open the boot.)*  
*Go over the overpass and turn left at the intersection.  
(Go over the flyover and turn left at the crossroads.)*  
*I have to buy a crib and baby-carriage.  
(I've got to buy a cot and pram.)*  
*The closet is full of trash.  
(The cupboard is full of rubbish.)*  
*Where did you buy those sneakers? What was the name of the store?  
(Where did you buy those trainers. What was the name of the shop?)*  
*I'm mad because you're stingy.  
(I'm angry because you're mean.)*  
*The subway's someplace near here.  
(The tube/underground is somewhere near here.)*  
*Do you want one-way or a round-trip?  
(Do you want a single (ticket) or a return?)*  
*Don't peek at me while I'm in the rest room.  
(Don't peep at me while I'm in the toilet.)*  
*My billfold is in my pocket book.  
(My wallet is in my handbag.)*  
*Did you mail the package?  
(Did you post the parcel?)*  
*I bought this topcoat last fall.  
(I bought this overcoat last autumn.)*

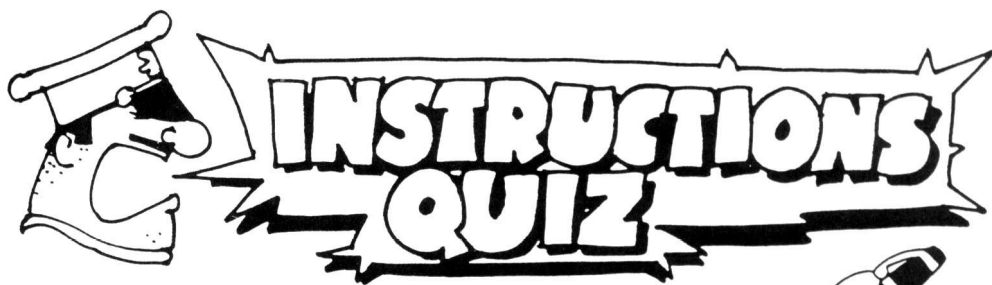

# INSTRUCTIONS QUIZ

Which instructor is giving which instruction? Write the number in the box next to the correct instruction.



1. keep fit instructor



2. dancing teacher



3. nurse



4. swimming instructor



9. theatre director



5. tennis coach



6. driving instructor



7. cookery teacher



8. language teacher

KEEP STRAIGHT ON. LOOK IN THE MIRROR. DON'T OVERTAKE YET. WAIT, NOW PULL OUT.

A.

DON'T SPEAK SO LOUDLY. YOU ARE IN LOVE WITH HER. STAND CLOSER.

B.

TOUCH YOUR TOES. DON'T BEND YOUR KNEES. KEEP YOUR BACK STRAIGHT.

C.

MAKE SURE THE WATER IS THE RIGHT TEMPERATURE. HOLD HER HEAD UP. DON'T BE AFRAID. NOW PLACE HER IN THE WATER.

D.

MEN, PUT YOUR LEFT FOOT FORWARD. LEAN BACK ON YOUR RIGHT FOOT. SWING YOUR PARTNER ROUND.

E.

DON'T TRY TO TRANSLATE EVERY WORD. LISTEN CAREFULLY. SPEAK AS MUCH AS POSSIBLE.

F.

LIE BACK IN THE WATER. DON'T PANIC. KEEP YOUR BODY STRAIGHT. SLOWLY KICK WITH YOUR LEGS.

G.

STIR SLOWLY. ADD A LITTLE WATER. DON'T LET IT BOIL. TURN DOWN THE FLAME A BIT.

H.

KEEP YOUR ARM STRAIGHT. KEEP YOUR EYE ON THE BALL. DON'T MOVE ABOUT TOO MUCH.

I.

## INSTRUCTIONS QUIZ

**Imperative:** *Keep straight on. Don't overtake yet.*

Working individually or in pairs, the players have to match the instructions to an instructor. The first player to do this correctly is the winner.

**Hints:** Make sure that the players fully understand the instructions by asking detailed comprehension questions after the matching task has been completed.

ANSWERS:      A6    B9    C1    D3    E2    F8    G4    H7    I5
--

## INSTRUCTIONS QUIZ – extension

**Imperative**

Divide the class into small teams of two to three players. Appoint team secretaries. The team secretaries, helped by the rest of their team, write a set of instructions which could be said by a different instructor to those on page 7, e.g.

*a policeman, a flying instructor, a doctor, a boss, an art teacher, a science teacher, a do-it-yourself instructor, an army officer, a gangleader, a priest.*

The instructions are then read out to the rest of the class who have to try to guess who is saying the words.

## MIME GAME

**Imperative:** *Come here, please.*

Get the attention of a student and with the use of gestures and mime get him or her to come out and join you at the front of the classroom. At the same time, by pointing to your mouth and with the use of gestures, prompt this student and the rest of the class to supply your words *Come out here, please* or *Come here, please*. Your mime does not have to be very good – the more amateur the mime the more the students will have to use language to guess what you want to say. Nod your head when somebody comes up with the right answer. Then with the use of gestures and mime get the student to sit down. Again get the class to guess what the instruction for this is: *Sit down, please*. Continue in the same way with other instructions, e.g. *Stand up, please, Take your sweater off, please, Switch on the light, please*. Then get the student you have demonstrated the activity with to choose another student to give new instructions to. And so on.

# OBSERVATION 5

Nicola is going away for the weekend. Find out what she is going to do by looking at the picture.

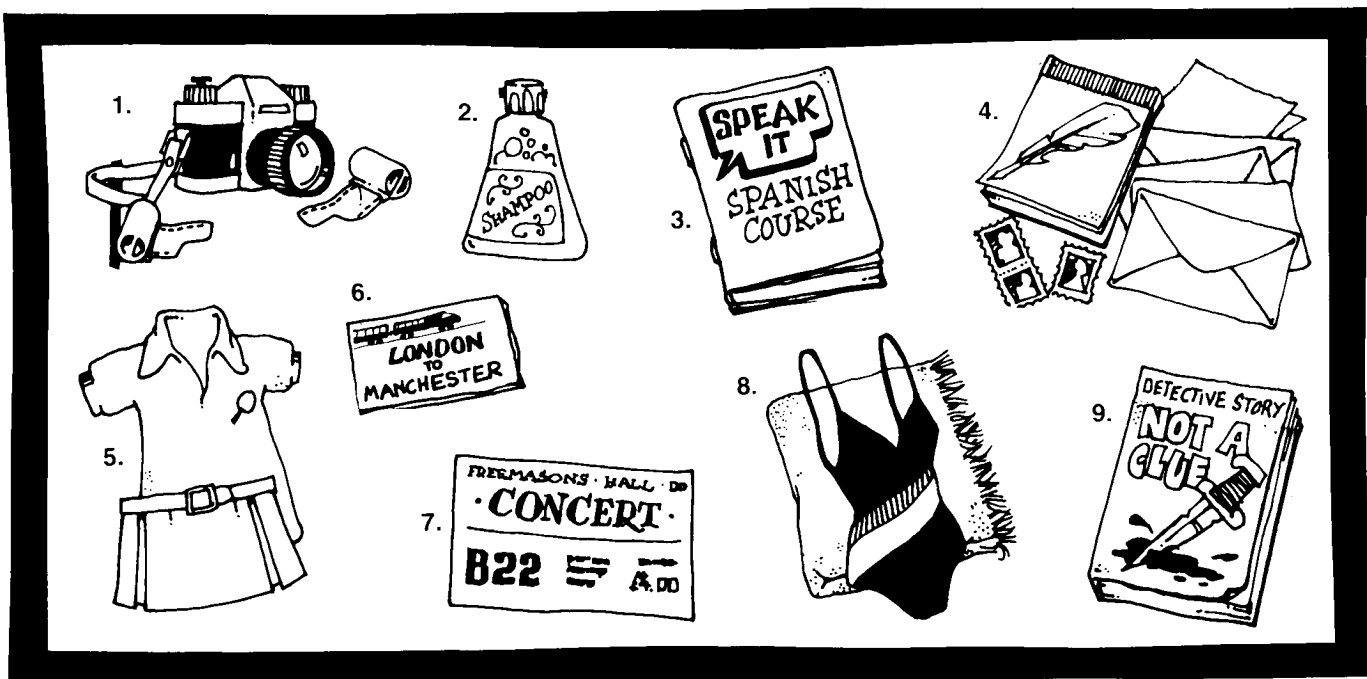
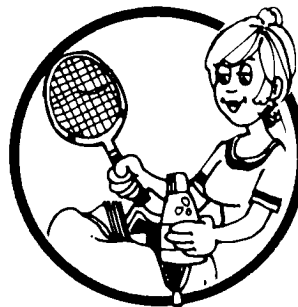

Use these verbs:

- play      go      go swimming      wash      write      travel      learn      take      read

1. She's going to take some photographs.
2. She's going to wash her hair.
3. ....
4. ....
5. ....
6. ....
7. ....
8. ....
9. ....



## OBSERVATION 5

**Going to Future:** *She's going to play tennis.*

Divide the class into small teams of two to three players and appoint team secretaries. Give the teams ten minutes to study the picture and for the team secretaries, helped by the rest of the players in their team, to write down sentences about what Nicola is going to do at the weekend. The team with the most correct sentences is the winner.

**Hints:** You could also get the teams to point out the evidence for their statements, e.g. *She's going to play tennis because she's taking her tennis things.*

- ANSWERS:**
1. She's going to take some photographs.
  2. She's going to wash her hair.
  3. She's going to learn Spanish.
  4. She's going to write some letters.
  5. She's going to play tennis.
  6. She's going to travel by train.
  7. She's going to go to a concert..
  8. She's going to go swimming
  9. She's going to read a detective story.

## JUST ABOUT

**Going to Future:** *Are you going to wash your hands?*

Tell the class that they have to guess what you are **just about** to do — then mime the preparatory actions for *having a bath* (e.g. *putting in the plug, turning on the taps*). At the same time the class asks you questions to try to find out what you are going to do, e.g. *Are you going to wash your hands? Are you going to clean your teeth?* Shake your head if their guesses are wrong and continue the mime — *testing the temperature of the water, taking off your dressing gown, stepping into the bath* — until somebody guesses what you are going to do. Your mime does not have to be good to do this activity — the more amateur the mime the more questions will have to be asked. But it is important that the action itself is **not** mimed but only the preparatory actions leading up to it. Then write an action on a slip of paper and hand it to the player who guessed your mime. He or she then mimes that action for the rest of the class to guess.

**Some example actions:**

*You are just about to drive away in your car.*

*You are just about to go to sleep.*

*You are just about to kiss somebody.*

*You are just about to light a fire.*

Continue in this way, with either you or the player whose mime has just been guessed, writing a new action for the next player to mime.

## DRAWING GAME

**Going to Future:** *You're going to draw a house.*

Begin to draw a simple line drawing (for example: a car).

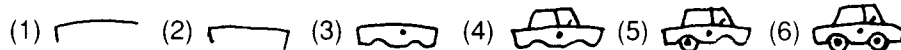

Stop after each stage to allow the class to try and guess what you are going to draw: *You're going to draw a house, You're going to draw a table, etc.*

Shake your head in reply until somebody guesses the right answer or you finish the drawing. Continue with other simple line drawings, e.g.

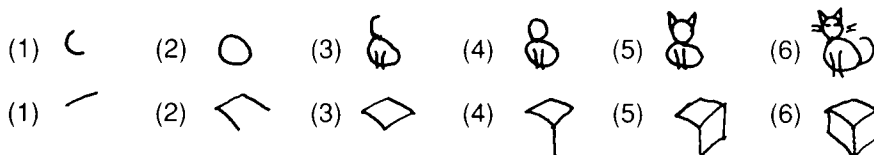

# WHERE?



## Famous Sights Quiz

I WANT TO GO AND SEE ALL THESE FAMOUS SIGHTS. WHERE WILL I HAVE TO GO TO SEE THEM?



1. The Brandenburg Gate



2. St. Sophia



3. The Statue of Liberty

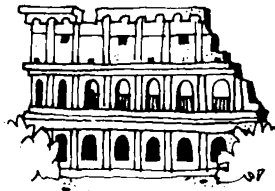

4. The Colosseum



5. Tower Bridge



6. The Golden Gate Bridge



7. The Golden Temple



8. The Arc de Triomphe

Use these words:

London

Kyoto

Berlin

Paris

Rome

San Francisco

New York

Istanbul

1. If you go to Berlin, you'll see the Brandenburg Gate.

2. ....

3. ....

4. ....

5. ....

6. ....

7. ....

8. ....

## WHERE?

**First Conditional (If + Will):** *If you go to Berlin, you'll see the Brandenburg Gate.*

Divide the class into two teams (Team A and Team B) and appoint team secretaries. The team secretaries, helped by the rest of their team, write seven *If you go, you'll see ...* sentences, joining the famous sights to the correct place names. The first team to complete this correctly is the winner.

**Hints:** You could extend this game by getting both teams to write five *If you go to + famous place ...* clauses and five *You'll see + famous sight* clauses. The five places shouldn't have anything to do with the five sights. For example one team might write:

*If you got to Pisa...; If you go to Athens...; If you go to the Louvre in Paris...;  
If you go to Rio...; If you go to Nepal...;  
you'll see the White House; you'll see Mount Etna; you'll see the Pyramids;  
you'll see the Colosseum; you'll see the 'Bridge of Sighs'.*

Each team in turn then asks the other team to complete one of their half sentences, for example:

*If you go to Pisa, ... you'll see the Leaning Tower.*

Score one point per correct sentence. At the end, the team with the most points is the winner.

- |          |   |
|----------|---|
| ANSWERS: | 1. If you go to Berlin, you'll see the Brandenburg Gate.          |
|          | 2. If you go to Istanbul, you'll see St. Sophia.                  |
|          | 3. If you go to New York, you'll see the Statue of Liberty.       |
|          | 4. If you go to Rome, you'll see the Colosseum.                   |
|          | 5. If you go to London, you'll see Tower Bridge.                  |
|          | 6. If you go to San Francisco, you'll see the Golden Gate Bridge. |
|          | 7. If you go to Kyoto, you'll see the Golden Temple.              |
|          | 8. If you go to Paris, you'll see the Arc de Triomphe.            |

## LOCAL KNOWLEDGE QUIZ

**First Conditional (If + Will/Might):** *How long will it take if I travel to Brighton by train?  
Who might you meet if you go to Buckingham Palace?*

Divide the class into two teams (Team A and Team B) and appoint team secretaries. The team secretaries, helped by the rest of their team, write eight questions about the local area. The questions should be in the first conditional. For example, if the local area is London, one team might write:

*Who might you meet if you go to Buckingham Palace? How long will it take if you travel to Brighton by train? What will you see if you go to Trafalgar Square? How much will you spend if you go to Green Park from here by Underground? What might you see if you go to Buckingham Palace? Why might you have to wait if you want to cross Tower Bridge? Which park will you see if you walk down Park Lane?*

Encourage the teams to write questions with different question words. Check that there is no duplication of questions and that the team that is to ask the question knows the answer. Check that the teams use *might* and *will* correctly. The teams then take it in turns to ask and answer these questions. Score one point for each correct answer. (In some cases approximate answers will do.) At the end, the team with the most points is the winner.